

Formulate Essential Banner 600

The Formulate Essential Banner 600 measures 23.5"W, 92"H and features a simple straight bungee-corded tube frame and a fabric graphic that simply slips over the frame. Perfect for any environment - from retail to trade show!



features and benefits:

- Straight bungee-corded aluminum tube frame with rounded corners
- Slip-over fabric graphic
- Easy to store and ship
- Quick to set up
- Kit includes: frame, dye-sublimated graphic, two feet
- Carry bag included
- One year hardware warranty against manufacturer defects

dimensions:

Hardware	Graphic
<p>Assembled unit: 25"W x 93"H x 15"D 635mm(w) x 2337mm(h) x 375mm(d)</p> <p>Approximate weight: 5 lbs / 3 kg</p>	<p>Refer to related graphic template for more information.</p> <p>One year warranty.</p> <p>Visit: www.tradeshowplus.com</p>

Shipping	additional information:
----------	-------------------------

<p>Packing case(s): 1 Box(es)</p> <p>Shipping dimensions: 33"l x 11"h x 3"d 839mm(l) x 280mm(h) x 77mm(d)</p> <p>Approximate total shipping weight: 6 lbs / 3 kg</p>	<p>Graphic material: Dye-sublimation pillowcase fabric</p> <p>When included in a larger kit, a different packaging solution will be listed to accommodate all contents of the kit. Individual packaging no longer provided.</p>
	<p>1 person assembly recommended:</p> 

We are continually improving and modifying our product range and reserve the right to vary the specifications without prior notice. All dimensions and weights quoted are approximate and we accept no responsibility for variance. E&OE. See Graphic Templates for graphic bleed specifications.

Included In Your Kit

Tools, Components, & Connectors

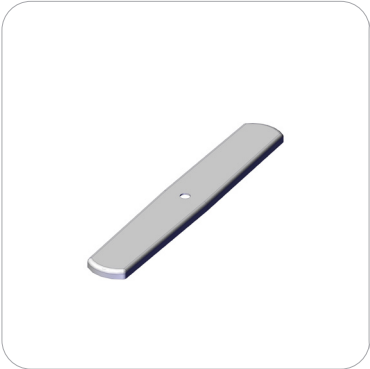

FMLT-ESS-S-600-2-FOOT x2

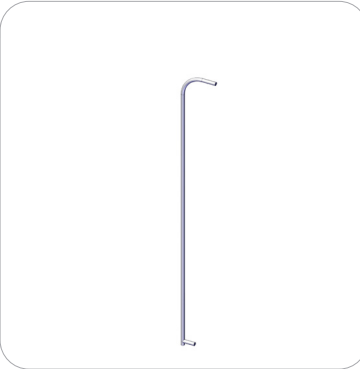

FMLT-ESS-S-600-2-LT x2

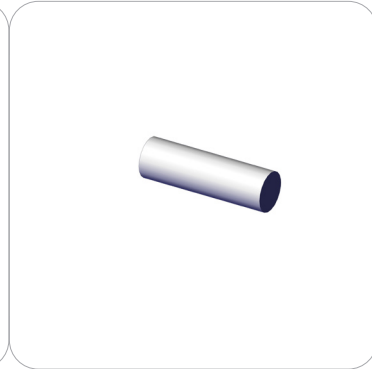

FMLT-ESS-S-600-2-T1 x1

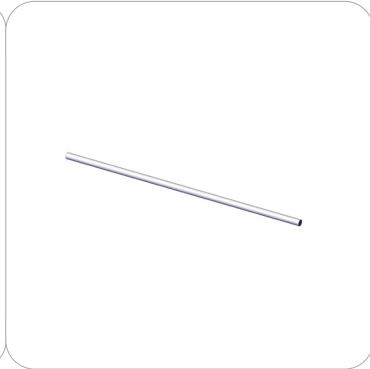

FMLT-ESS-S-600-2-T3 x1

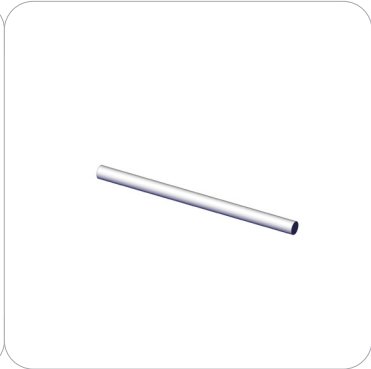

FMLT-ESS-S-600-2-T2 x1

Graphics

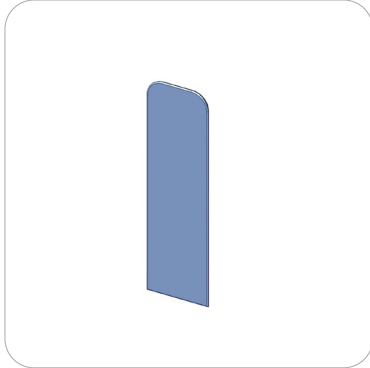

FMLT-ESS-S-600-G x1

Exploded Diagram

FMLT-ESS-S-600-2

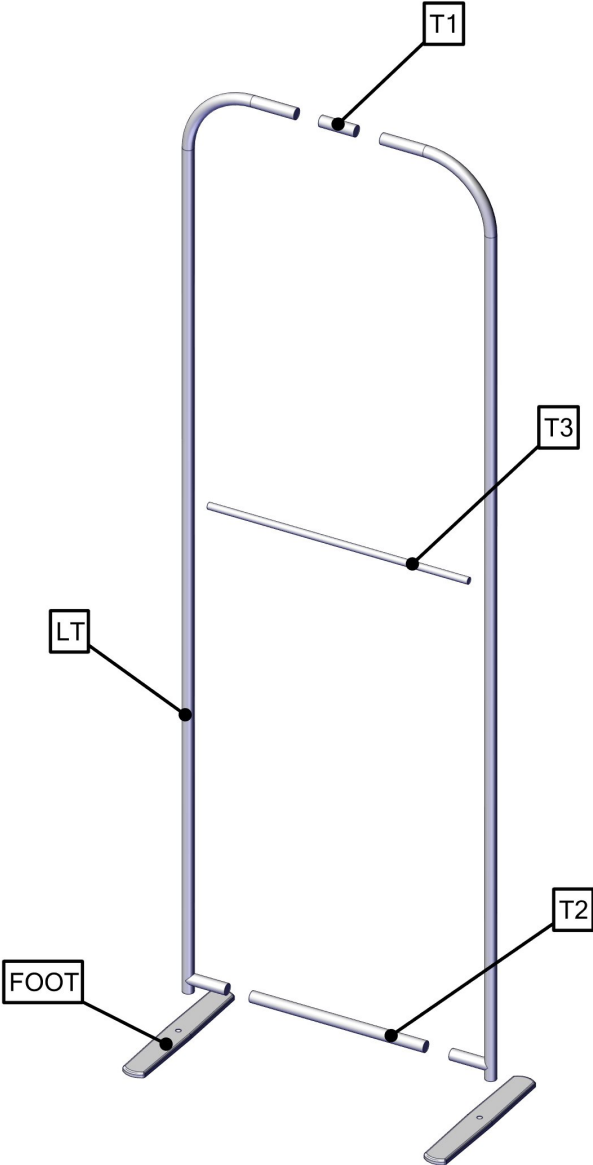

Labeling Diagram

FMLT-ESS-S-600-2

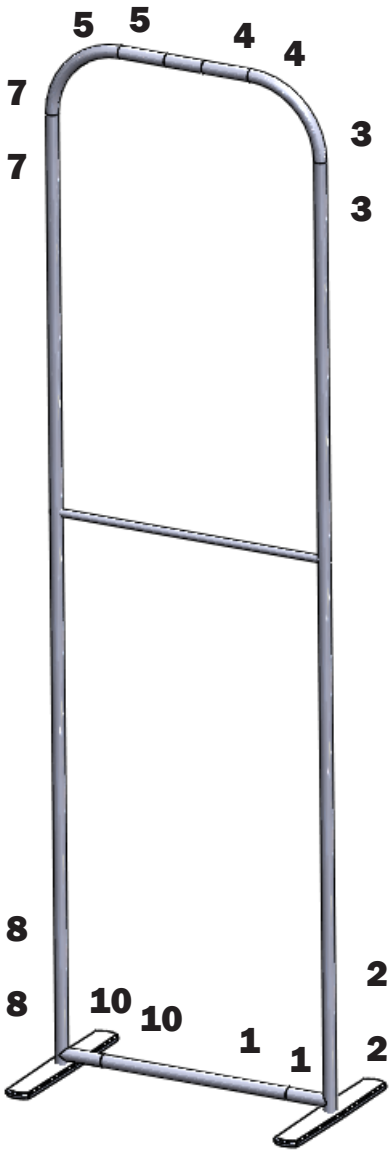

Kit Assembly

Step by Step

Step 1.

Gather the components to build the frame. Use the Exploded View and the Labeling Diagram for part labels.

Reference Connection Method(s) 1 for more details.

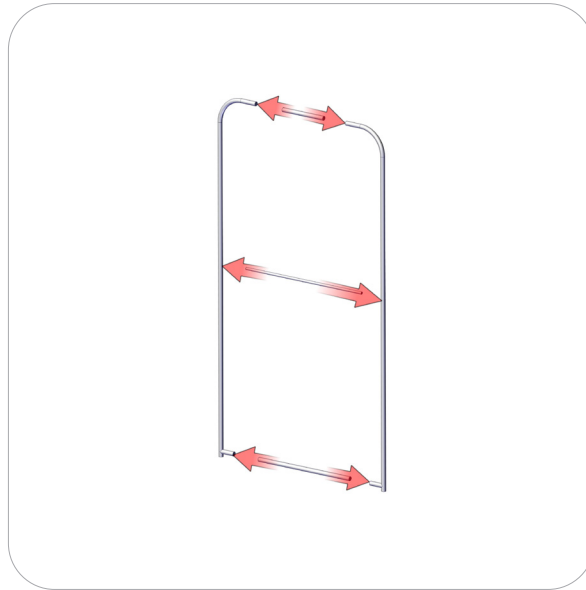

Step 2.

Gather the components to attach base hardware. Use the Exploded View and the Labeling Diagram for part labels.

Reference Connection Method(s) 2 for more details.

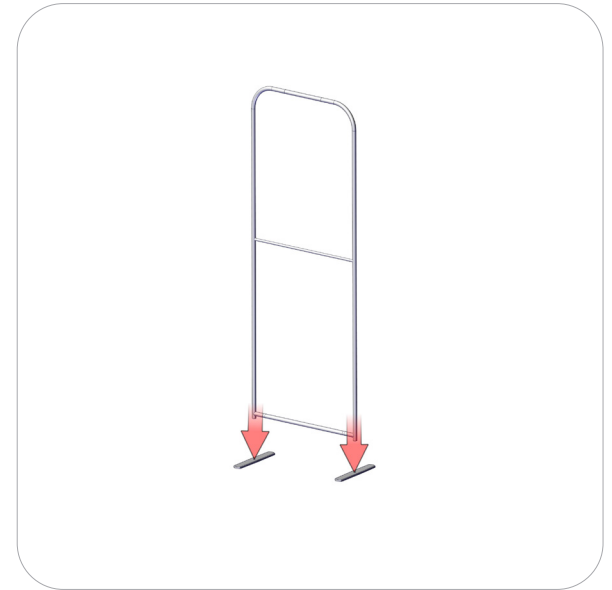

Step 3.

Gather the components to attach the graphic. Use the Exploded View and the Labeling Diagram for part labels.

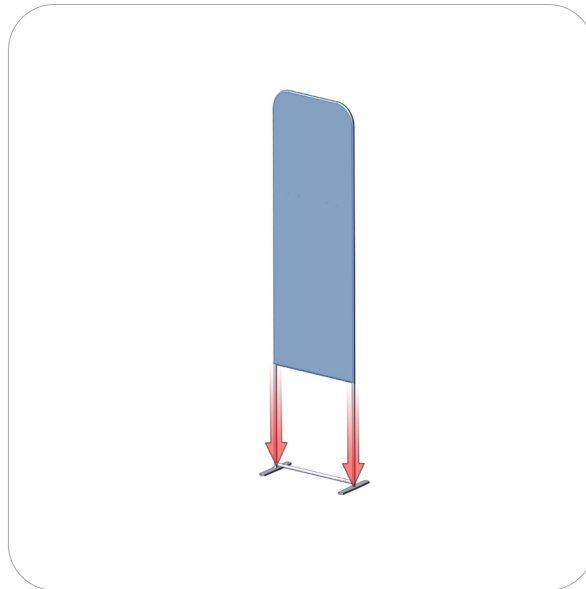
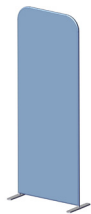

Step 4.

Setup is complete.

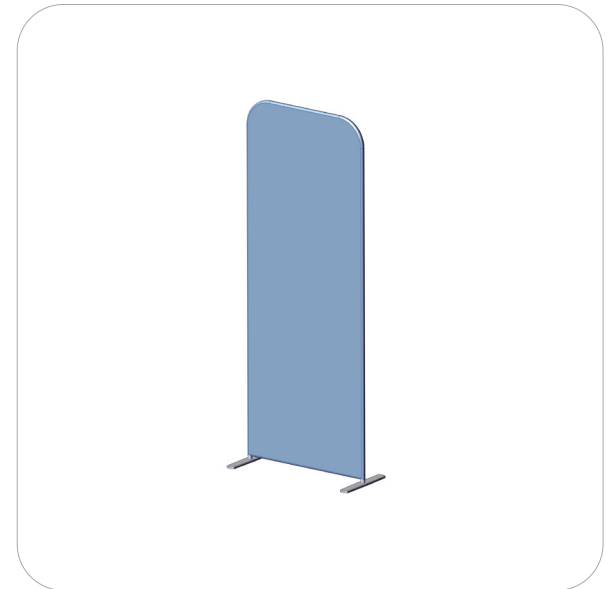

Connection Methods

Connection Method 1: FMLT-ESS-S-FOOT

Connection Method 2: Swage Tube with Snap Button

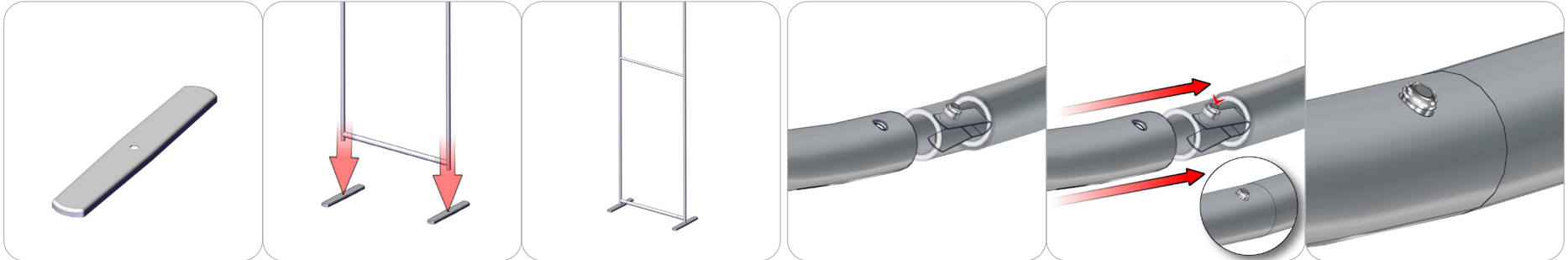

First, attach the base plate with the M10 screw. Once the base plate is in the desired position, fasten the set screw to hold the insert in place.

Attaching the tube swage design end and snap button is easy - simply press the snap button in and slide it into the next tube. With the tube on, make sure the snap button comes out all the way through the tube hole.