

# Formulate Designer Series 30ft Kit 06

Formulate Designer Series 30ft displays have unique stylistic features and shapes, are portable and easy to assemble. The aluminum tube frame features snap-buttons and/or spigot connections and zipper pillowcase fabric graphics. All displays come in portable, wheeled transit cases. Simply pull the pillowcase fabric graphic(s) over the frame and zip.

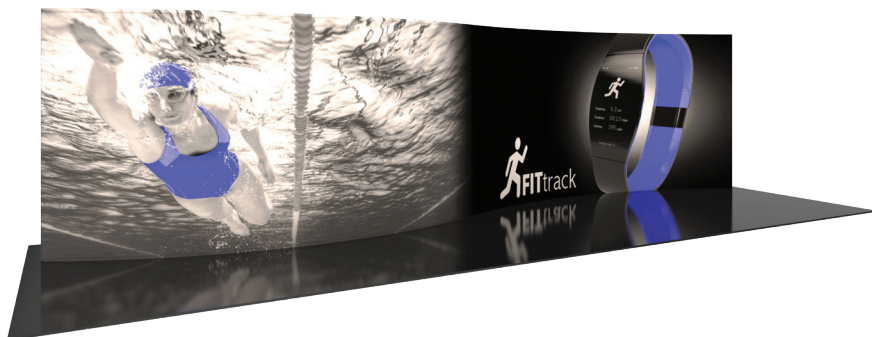

## features and benefits:

- Premium aluminum tube frames with snap button/ spigot assembly
- Serpentine shaped frame
- Easy to store and ship
- Quick to set up
- Weighted feet for added stability
- Zipper pillowcase fabric graphic
- Lifetime limited hardware warranty against manufacturer defects

## dimensions:

Hardware

Graphic

Assembled unit:  
350" w x 92" h x 48" d  
8890mm(w) x 2337mm(h) x 1219mm(d)

Refer to related graphic template for more information.

Approximate weight with cases:  
135 lbs / 61.2 kgs

Visit:  
[www.tradeshowplus.com](http://www.tradeshowplus.com)

Shipping

Packing case(s):  
2 OCE Cases

Shipping dimensions:  
OCE: Expandable case length(l) may vary  
40"-66" l x 18" h x 18" d  
1016mm-1677mm(l) x 458mm(h) x 458mm(d)

Approximate total shipping weight  
(includes cases & graphics):  
168 lbs / 76.2 kgs

## additional information:

Graphic material:  
dye-sublimation zipper pillowcase fabric

We are continually improving and modifying our product range and reserve the right to vary the specifications without prior notice. All dimensions and weights quoted are approximate and we accept no responsibility for variance. E&OE. See Graphic Templates for graphic bleed specifications.

# Included In Your Kit

Tools, Components,  
& Connectors



HEX KEY SET x1

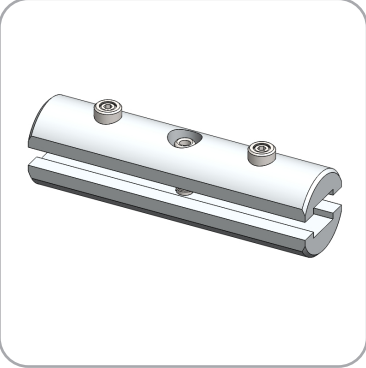

ES30 x8

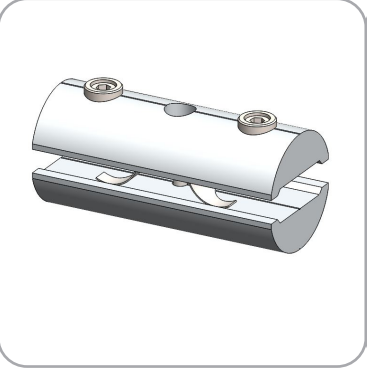

ES50-1 x12

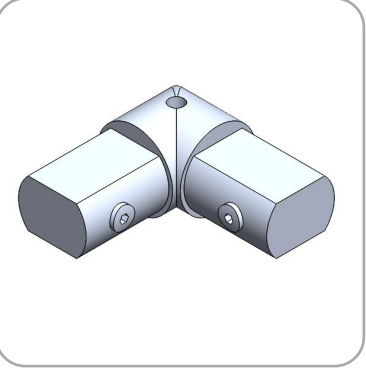

ES50-2W x4

Graphics

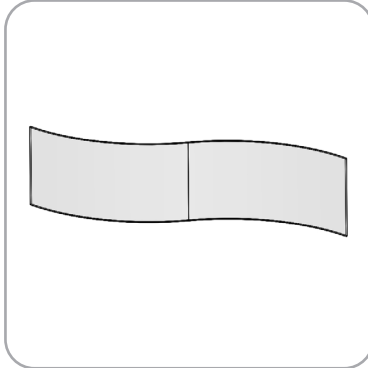

FMLT-DS-30-06-G x1

# Included In Your Kit

Tubes

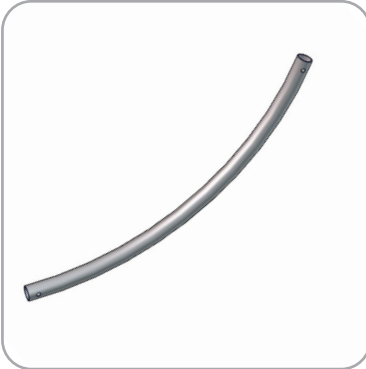

DS-30-06-T1 x4

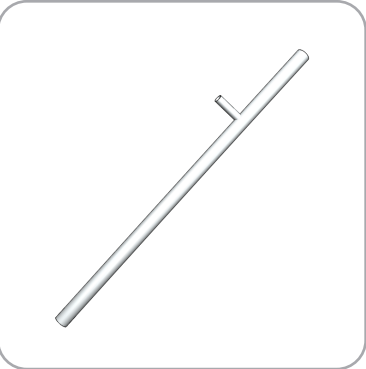

DS-30-06-T2 x2

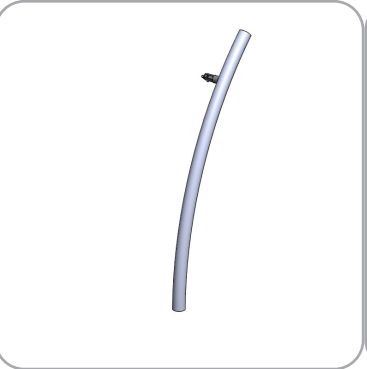

DS-30-06-T3 x2

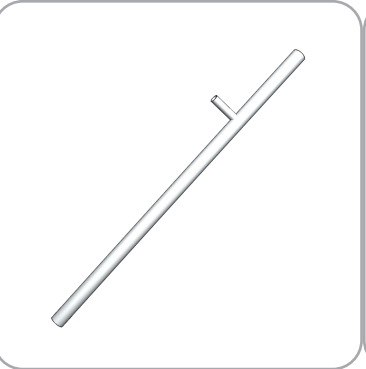

DS-30-06-T4 x2

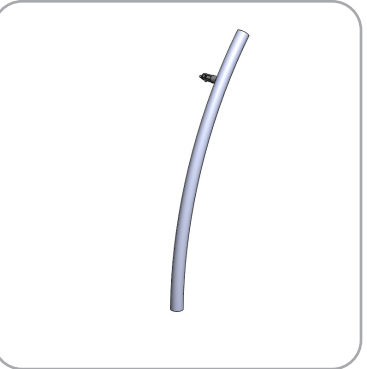

DS-30-06-T5 x2



DS-30-06-T6 x4



DS-30-06-T7 x8

# Exploded View

FMLT-DS-30-06

FRAME A

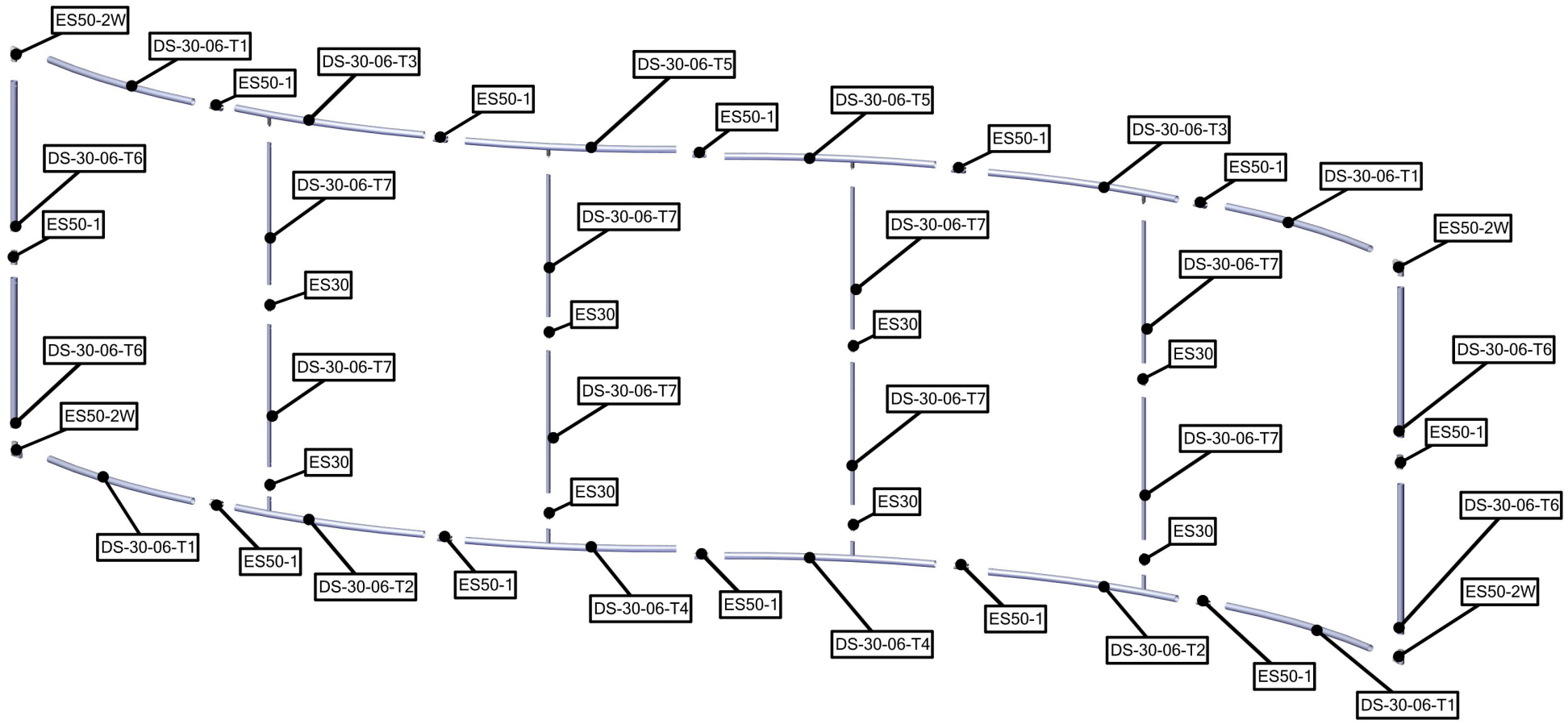

# Labeling Diagram

FMLT-DS-30-06

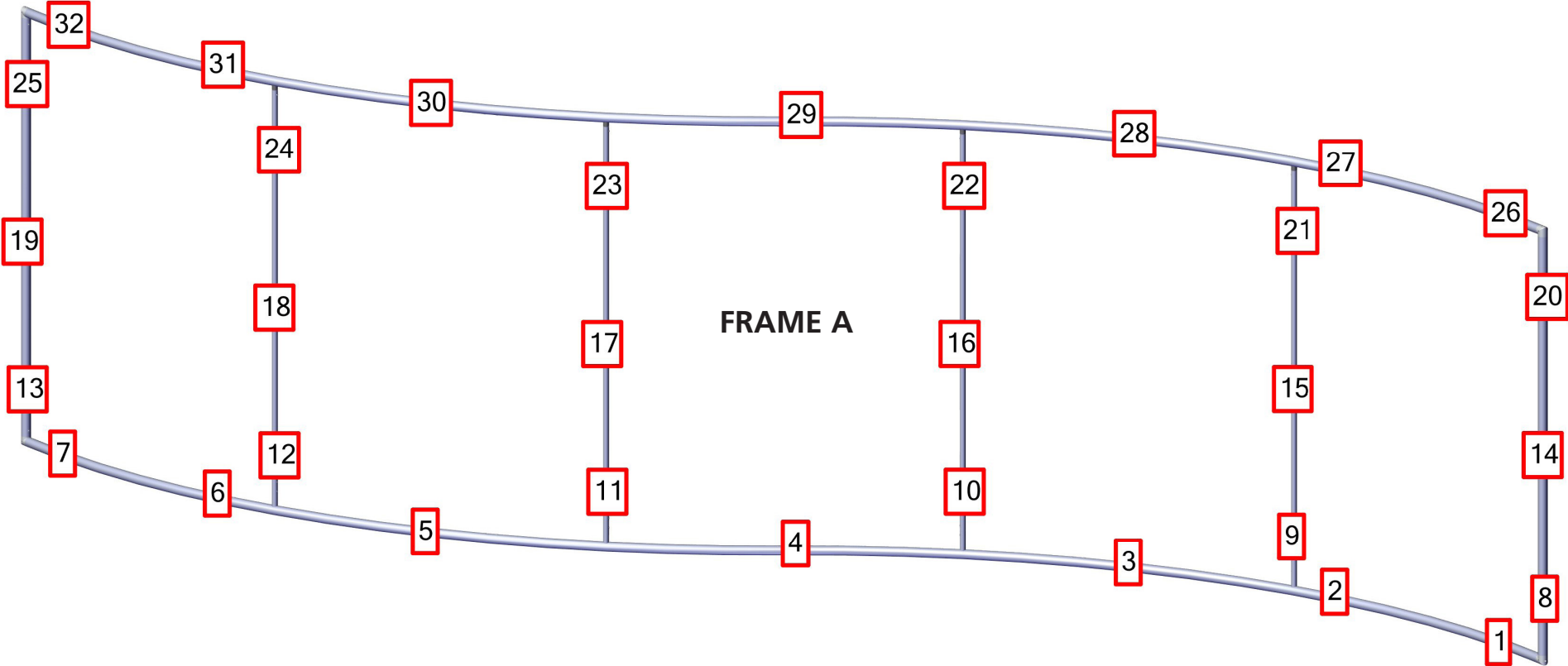

# Connection Methods

Formulate™ structures use a number of different yet simple connection methods. Your kit will include one or more of the connection methods shown below. Steps within the Kit Assembly will reference a specific method for each connection point.

## Connection Method 1: ES30 / ES50 / ES75

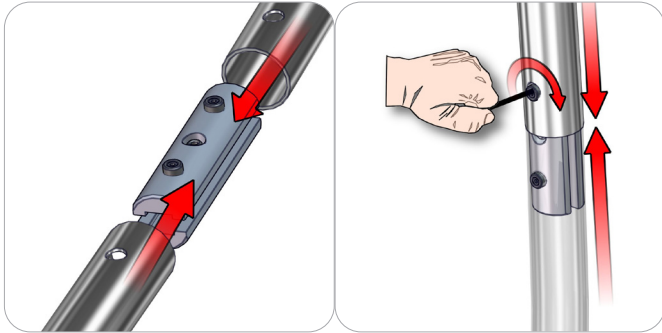

Compress the unlocked connector and slide one tube onto each end. Lock both screws carefully using your hex key tool. Be sure to lock securely, but do not overtighten.

## Connection Method 2: Snap Buttons & Swage

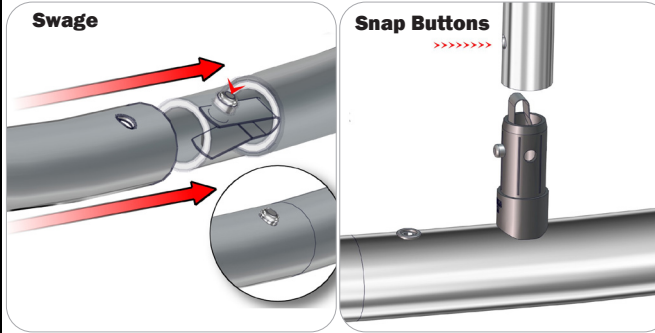

Locate the snap button on the connector or swage tube. Locate the hole on the corresponding tube. Press the snap button with your thumb and slide the tube and connector together so that the snap button snaps fully into the lock hole. To disassemble, press the snap button and pull apart.

## Connection Method 3: ES30-90B / ES30-I / ES30-C

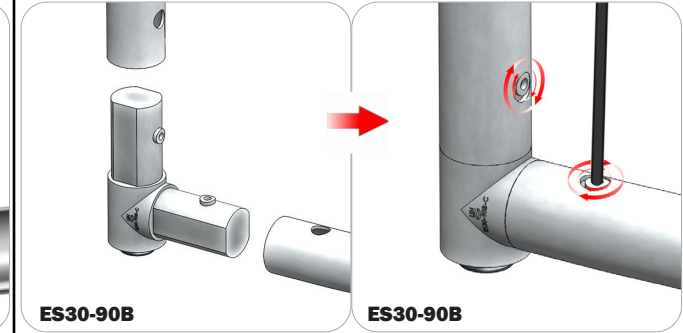

Compress one unlocked end of the connector and slide it through one tube end. Compress the other end of the connector and slide the second tube on. Lock both screws carefully using your hex key tool. Be sure to lock securely, but do not overtighten.

## Connection Method 4: Tube Clamps

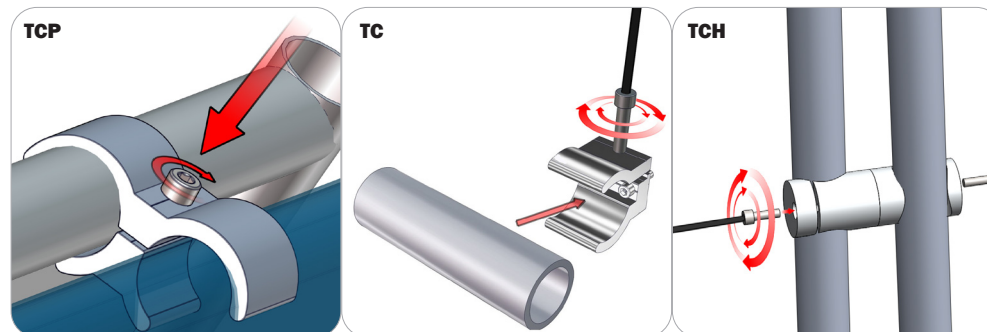

Be sure to fully assemble all frames before using clamps. With the clamp unlocked, place one tube of the first frame into the mouth of the clamp. Place the second tube (if applicable) into the second mouth of the clamp. With both frame's tubes in the clamp, be sure to lock securely, but do not overtighten.

# Kit Assembly

## Step by Step

### Step 1.

Assemble Frame A according to the Labeling Diagram.

Please reference Connection Methods 1 and 2 for more details.

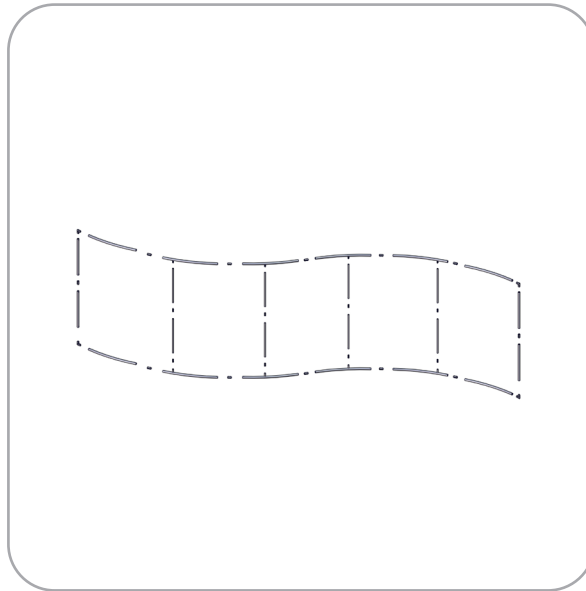
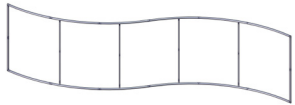

### Step 2.

Apply FMLT-DS-30-06-G graphic to the frame by pulling the pillowcase over the top.

Zipper located to the bottom of the Graphic.

