

Formulate Designer Series 20ft Kit 02

Formulate Designer Series 20ft displays have unique stylistic features and shapes, are portable and easy to assemble. The aluminum tube frame features snap-buttons and/ or spigot connections and zipper pillowcase fabric graphics. All displays come in portable, wheeled transit cases. Simply pull the pillowcase fabric graphic(s) over the frame and zip.

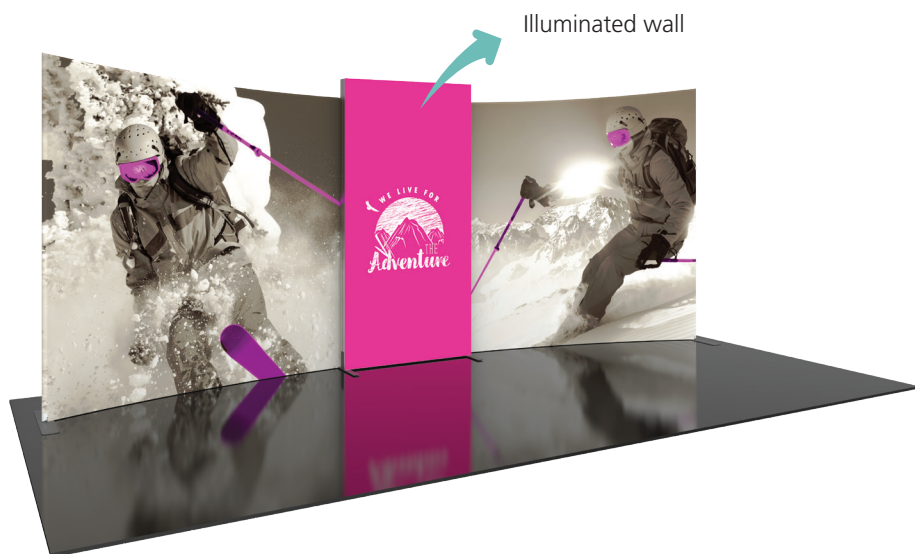

features and benefits:

- Premium aluminum tube frames with snap button/ spigot assembly
- Easy to store and ship
- Quick to set up
- Weighted feet for added stability
- Two zipper pillowcase fabric graphics
- Center wall features extrusion frame, LED lights and push-fit fabric graphics
- Lifetime limited hardware warranty against manufacturer defects

dimensions:

Hardware	Graphic
<p>Assembled unit: 230" w x 96" h x 40" d 5845mm(w) x 2438mm(h) x 1015mm(d)</p> <p>Approximate weight with cases: 190 lbs / 86.2 kgs</p>	<p>Refer to related graphic template for more information.</p> <p>Visit: www.tradeshowplus.com</p>
<p>Shipping</p> <p>Packing case(s): 1 OCH 2 OCE</p> <p>Shipping dimensions: OCH: 12" l x 26" h x 50" d 304mm(l) x 661mm(h) x 1270mm(d)</p> <p>Shipping dimensions: OCE: Expandable case length (l) may vary 40" - 66" l x 18" h x 18" d 1016mm-1677mm(l) x 458mm(h) x 458mm(d)</p> <p>Approximate total shipping weight (includes cases & graphics): 212 lbs / 96.2 kgs</p>	<p>additional information:</p> <p>Graphic material: dye-sublimation zipper pillowcase fabric</p> <p>Frame A and B stand independently of one another, no connection hardware required.</p>

We are continually improving and modifying our product range and reserve the right to vary the specifications without prior notice. All dimensions and weights quoted are approximate and we accept no responsibility for variance. E&OE. See Graphic Templates for graphic bleed specifications.

Included In Your Kit

Tools, Components,
& Connectors



HEX KEY SET x1

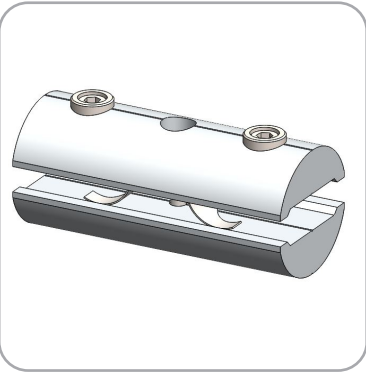

ES50-1 x10

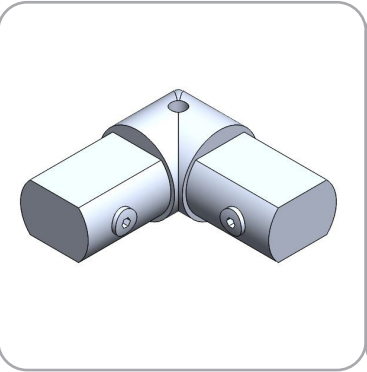

ES50-2W x2

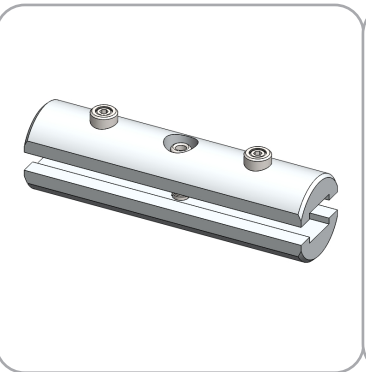

ES30 x8

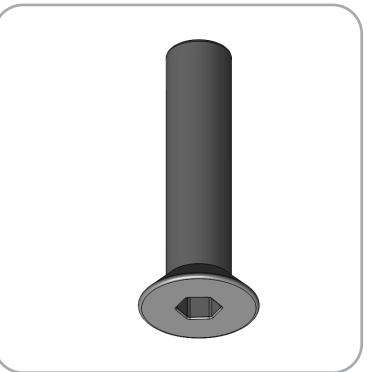

LN114-SCRW x2

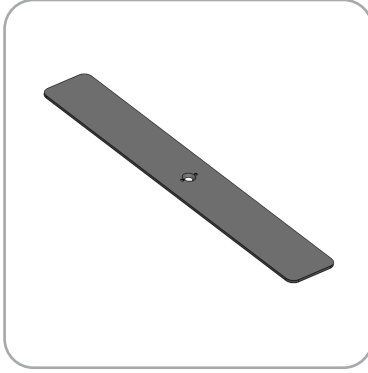

PLT-BP-LN114-S2-650 x2

Graphics

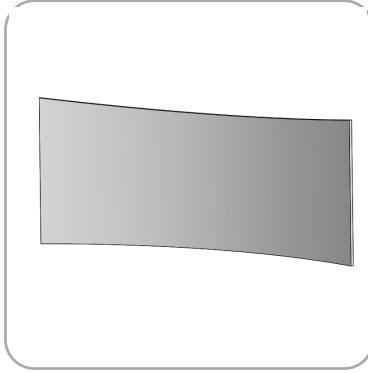

FMLT-DS-20-02-A x1

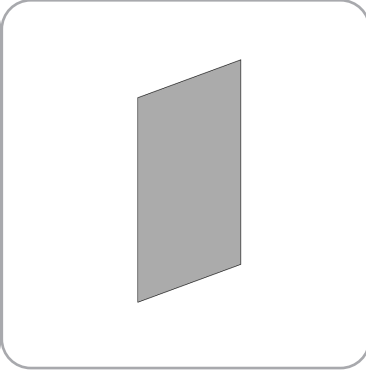

FMLT-DS-20-02-B x1

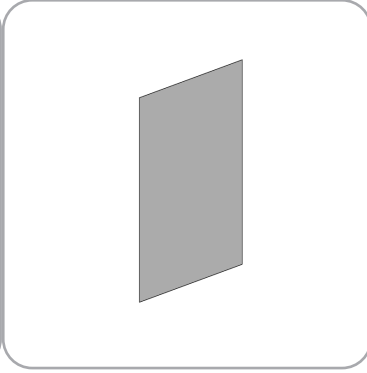

FMLT-DS-20-02-OP-LN x1

Included In Your Kit

Tubes

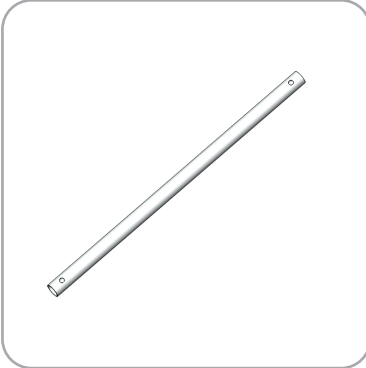

FMLT-DS-20-02-A-T1 x2

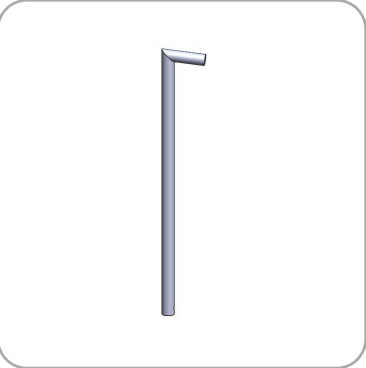

FMLT-DS-20-02-A-T2 x2

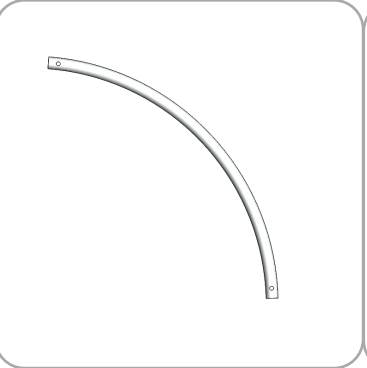

FMLT-DS-20-02-A-T3 x4

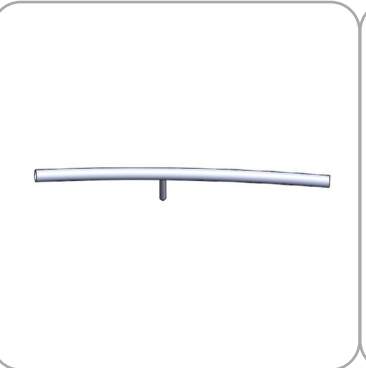

FMLT-DS-20-02-A-T4 x1



FMLT-DS-20-02-A-T5 x1

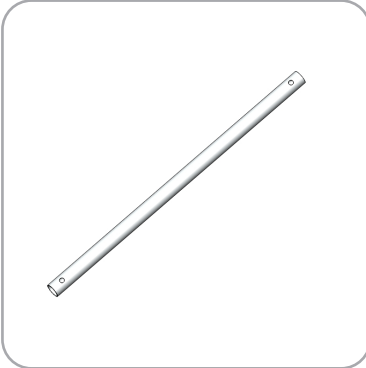

FMLT-DS-20-02-A-T6 x4

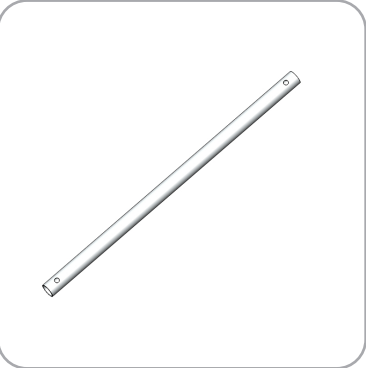

FMLT-DS-20-02-A-T7 x4



FMLT-DS-20-02-A-T8 x1

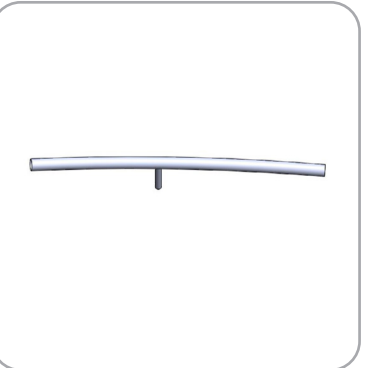

FMLT-DS-20-02-A-T9 x1

Exploded View

FMLT-DS-20-02

FRAME A

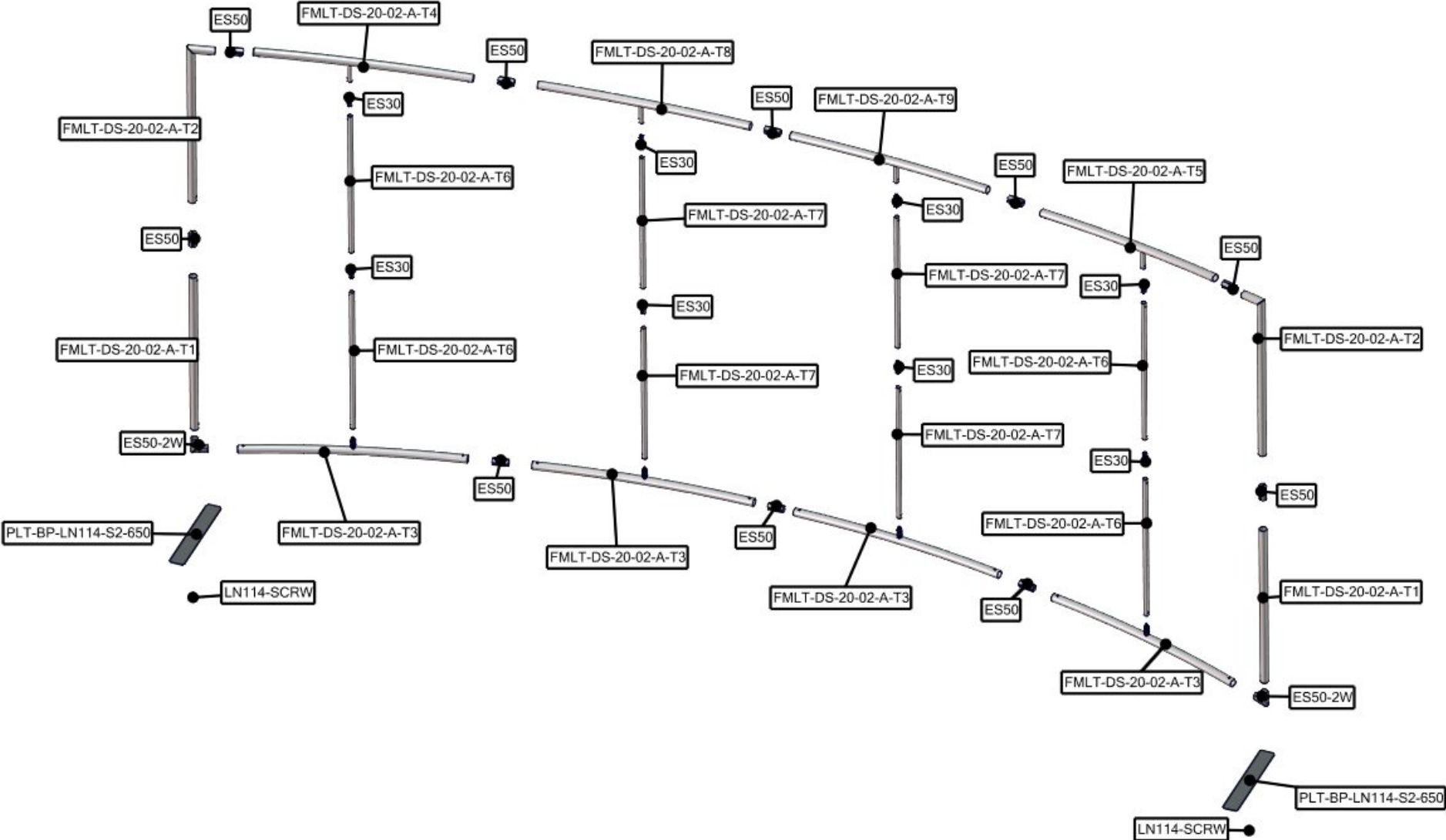

Labeling Diagram

FMLT-DS-20-02

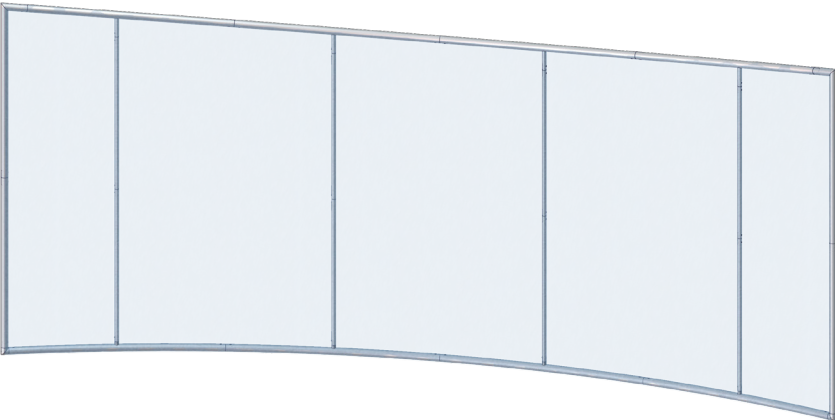
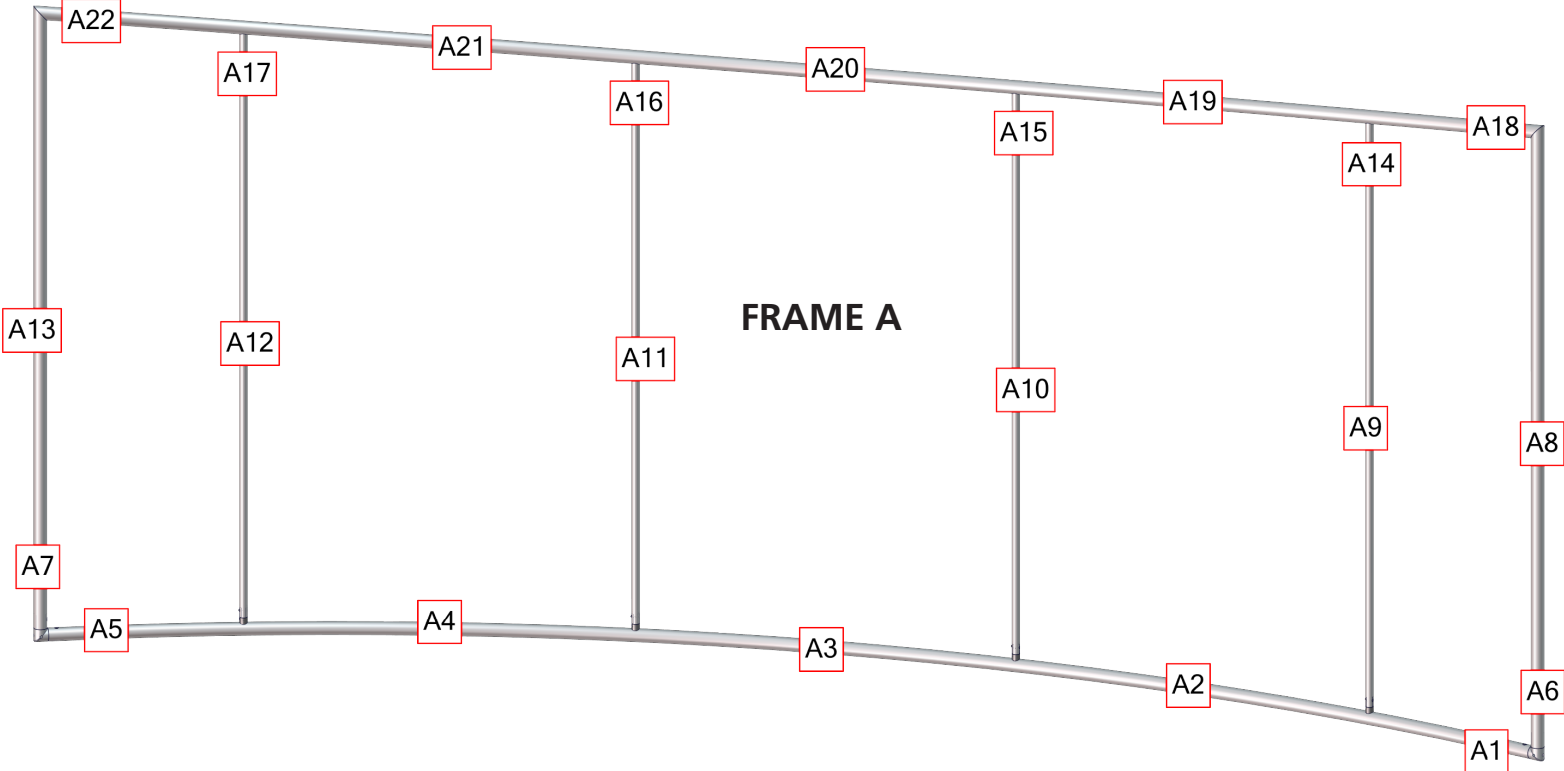

Frame A and B stand independently of one another, no connection hardware required.

Connection Methods

Formulate™ structures use a number of different yet simple connection methods. Your kit will include one or more of the connection methods shown below. Steps within the Kit Assembly will reference a specific method for each connection point.

Connection Method 1: ES30 / ES50 / ES75

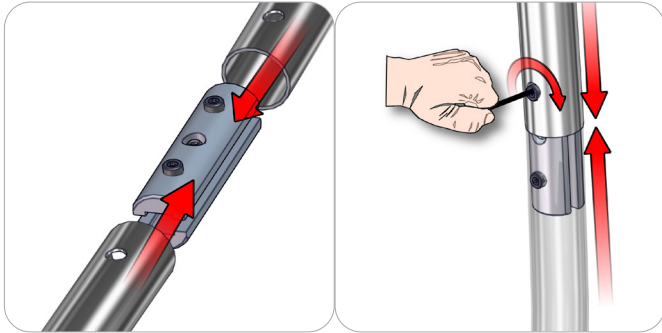

Compress the unlocked connector and slide one tube onto each end. Lock both screws carefully using your hex key tool. Be sure to lock securely, but do not overtighten.

Connection Method 2: Snap Buttons & Swage

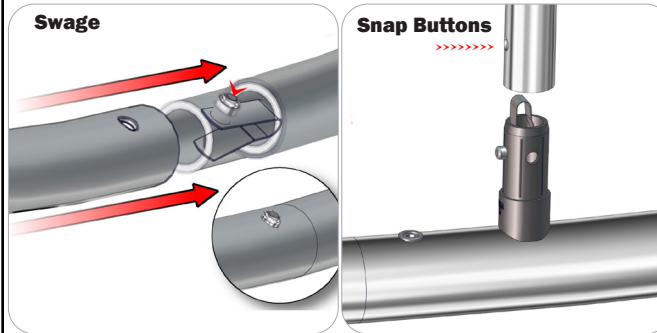

Locate the snap button on the connector or swage tube. Locate the hole on the corresponding tube. Press the snap button with your thumb and slide the tube and connector together so that the snap button snaps fully into the lock hole. To disassemble, press the snap button and pull apart.

Connection Method 3: ES30-90B / ES30-I / ES30-C

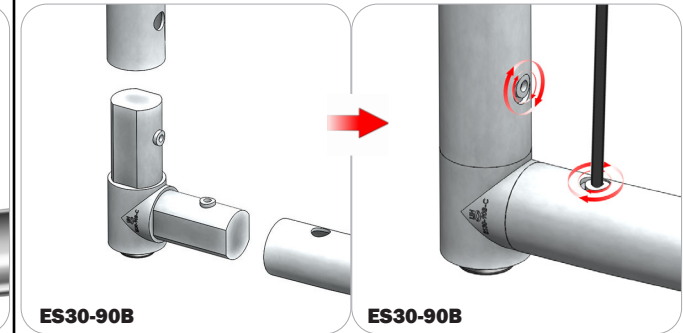

Compress one unlocked end of the connector and slide it through one tube end. Compress the other end of the connector and slide the second tube on. Lock both screws carefully using your hex key tool. Be sure to lock securely, but do not overtighten.

Connection Method 4: Tube Clamps

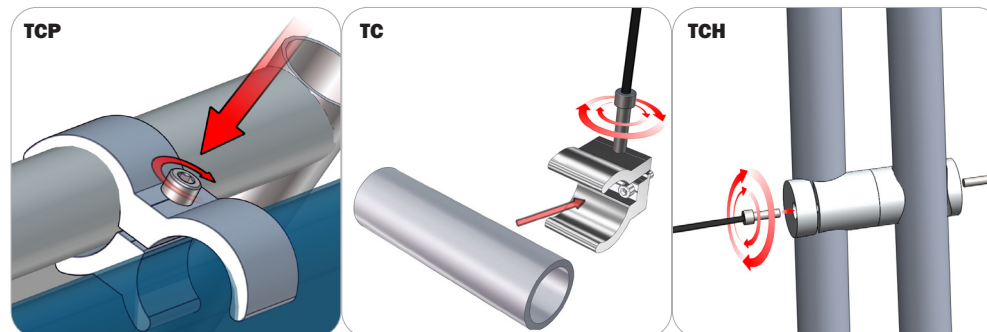

Be sure to fully assemble all frames before using clamps. With the clamp unlocked, place one tube of the first frame into the mouth of the clamp. Place the second tube (if applicable) into the second mouth of the clamp. With both frame's tubes in the clamp, be sure to lock securely, but do not overtighten.

Kit Assembly

Step by Step

Step 1.

Locate the components necessary for assembling Frame A. Assemble your frame in order according to the Labeling Diagram.

Please reference Connection Methods 1, 2 and 3 for more details.

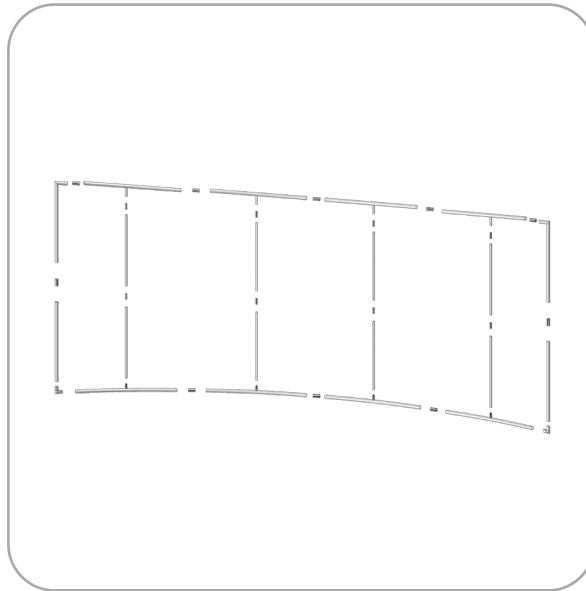

Step 2.

Fit graphic A onto Frame A. For ease of installation, pull the fabric cover over the top of the frame while the frame rests flat on the floor. Zip to enclose.

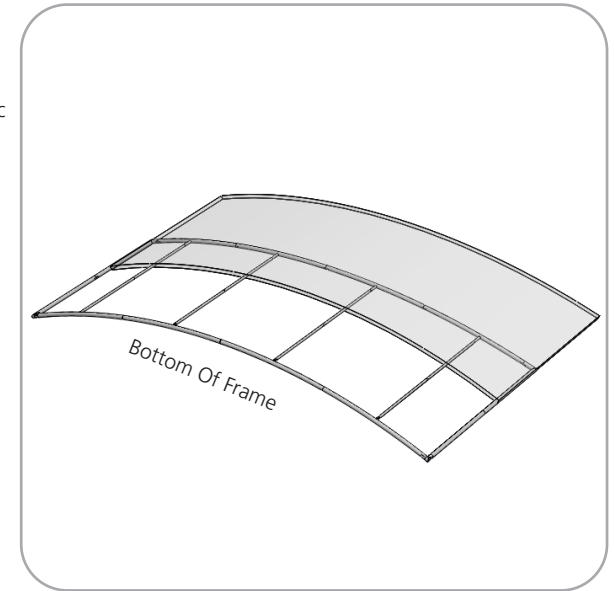
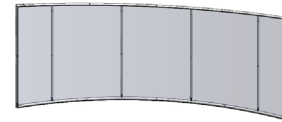

Step 3.

Locate the PLT-BP-LN114-S2-650's and LN114-SCRW's. With the provided hex key set tool, fasten the base plates onto the bottom ES50-2W connectors of Frame A.

Setup Complete.

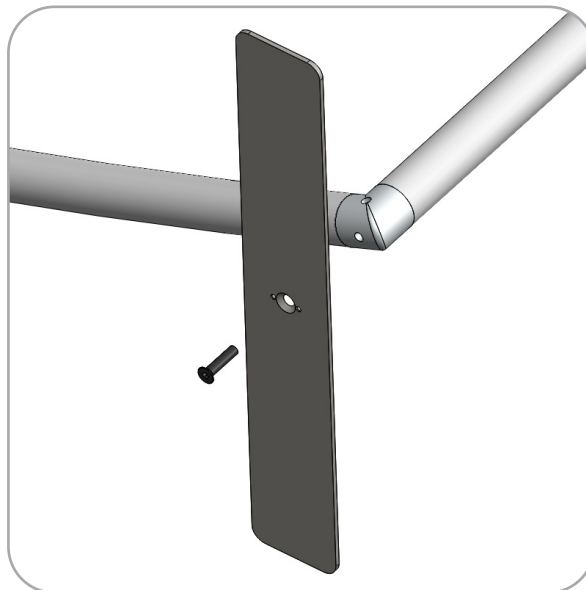
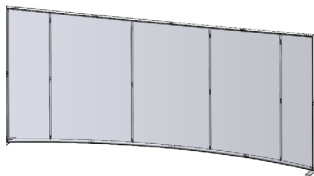

Vector Frame Light Box R-04

VF-LB-R-04

Vector Frame™ fabric light boxes feature durable 100mm aluminum extrusion frames, push-fit back-lit fabric graphics and LED top and bottom lighting. Single and double-sided graphic options are available. LED lights come adhered to the frame, making set-up as simple as assembling the frame, applying the push-fit graphics and plugging in the electrical cord!

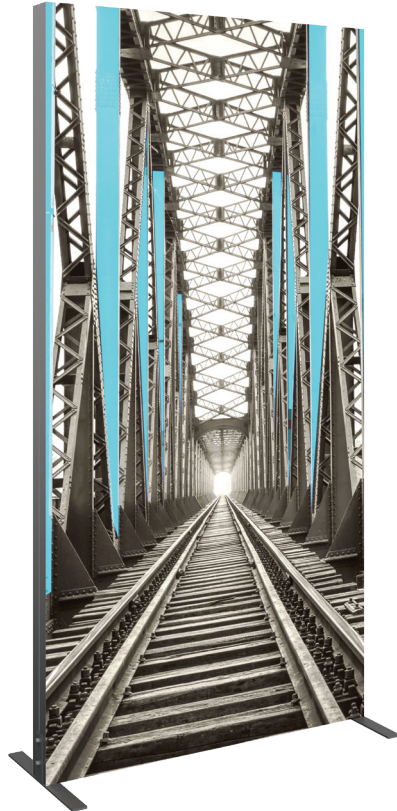

features and benefits:

- 100mm (4") silver extrusion frame
- Integrated LED lighting strips top & bottom
- Single or double-sided SEG dye-sublimated push-fit fabric graphics
- Easy assembly
- Comes packaged with one OCH wheeled molded case for transport and storage
- Lifetime hardware warranty against manufacturer defects

dimensions:

Hardware

Assembled unit:
48" w x 94.7" h x 19.7" d
1222mm(w) x 2405mm(h) x 500mm(d)

Approximate weight with cases:
67 lbs / 30 kgs

Shipping

Packing case(s):
1 OCH

Shipping dimensions:
50" l x 29" h x 12" d
1270mm(l) x 737mm(h) x 305mm(d)

Approximate total shipping weight
(includes cases & graphics):
71 lbs / 32 kgs

Graphic

Refer to related graphic template for more information.

Visit:
www.exhibitors-handbook.com/graphic-templates

additional information:

Graphic material:
dye-sublimation fabric

Power requirements:
24V / 3.0A / 72 watts per transformer
One transformers per unit

We are continually improving and modifying our product range and reserve the right to vary the specifications without prior notice. All dimensions and weights quoted are approximate and we accept no responsibility for variance. E&OE. See Graphic Templates for graphic bleed specifications.

Included In Your Kit

Tools, Components, & Connectors



5MM ALLEN-T x1

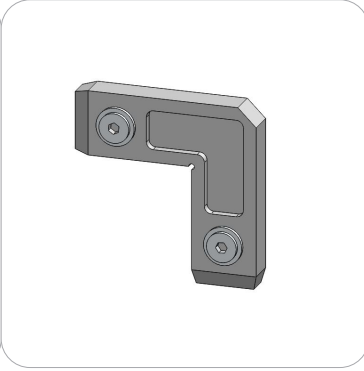

CB9 x4

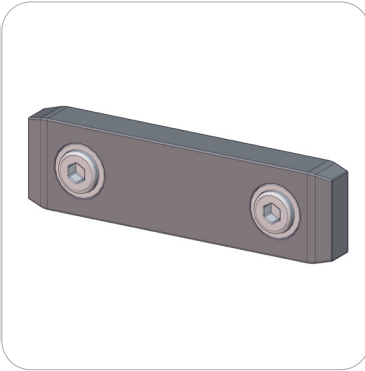

IB2 x2

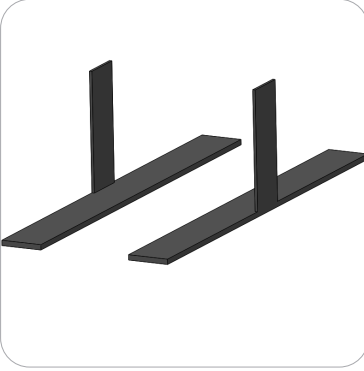

SW-FOOT-500-2 x1

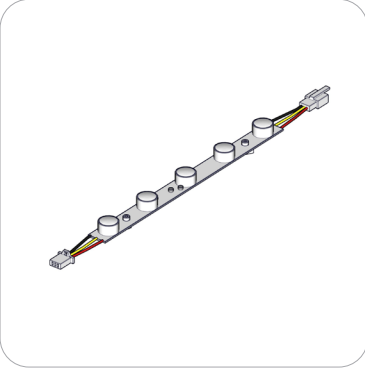

LED-WHT-DB-300 x6

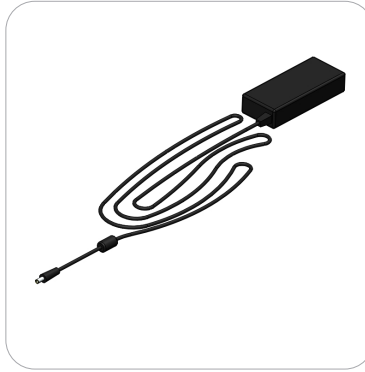

LED-DB-PWRSUPPLY x1



LED-DB-PWRCORD x1

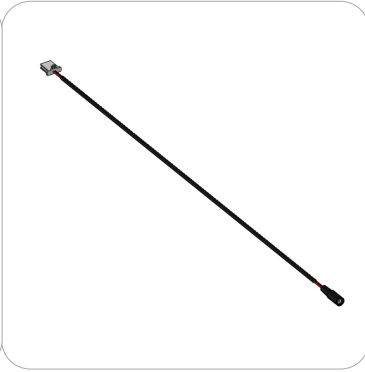

LED-DB-CL-DCJ-600 x1



LED-DB-CL-2400 x1

Graphics

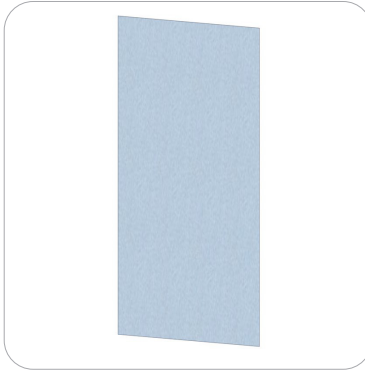

VF-LB-R-04-S-G x1



VF-LB-R-04-OP-LN x1

Included In Your Kit

Extrusions

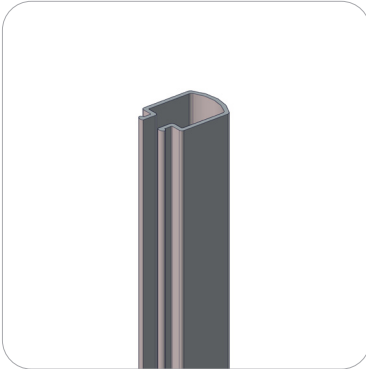

WME-1000 x2

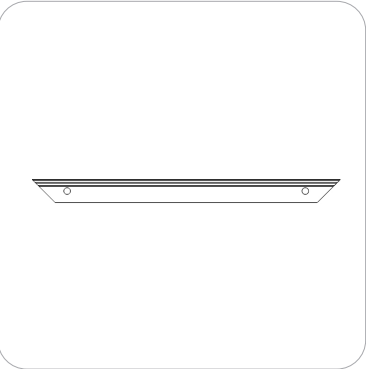

PHFC4-1200-MCB9-MCB9 x2

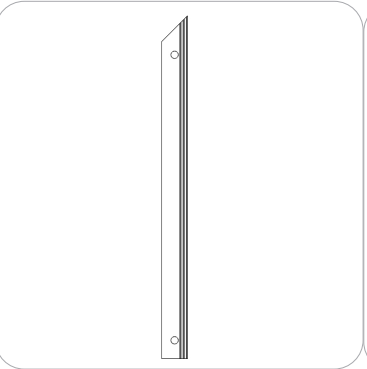

PHFC4-1200-L1-MCB9 x3

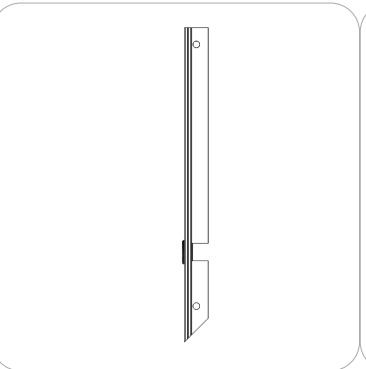

PHFC4-1200-L1-MCB9-GR x1

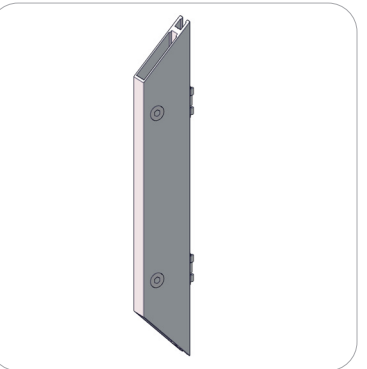

AF16-300-MCB4-MCB4-SIDE x2

Exploded View

VF-LB-R-04

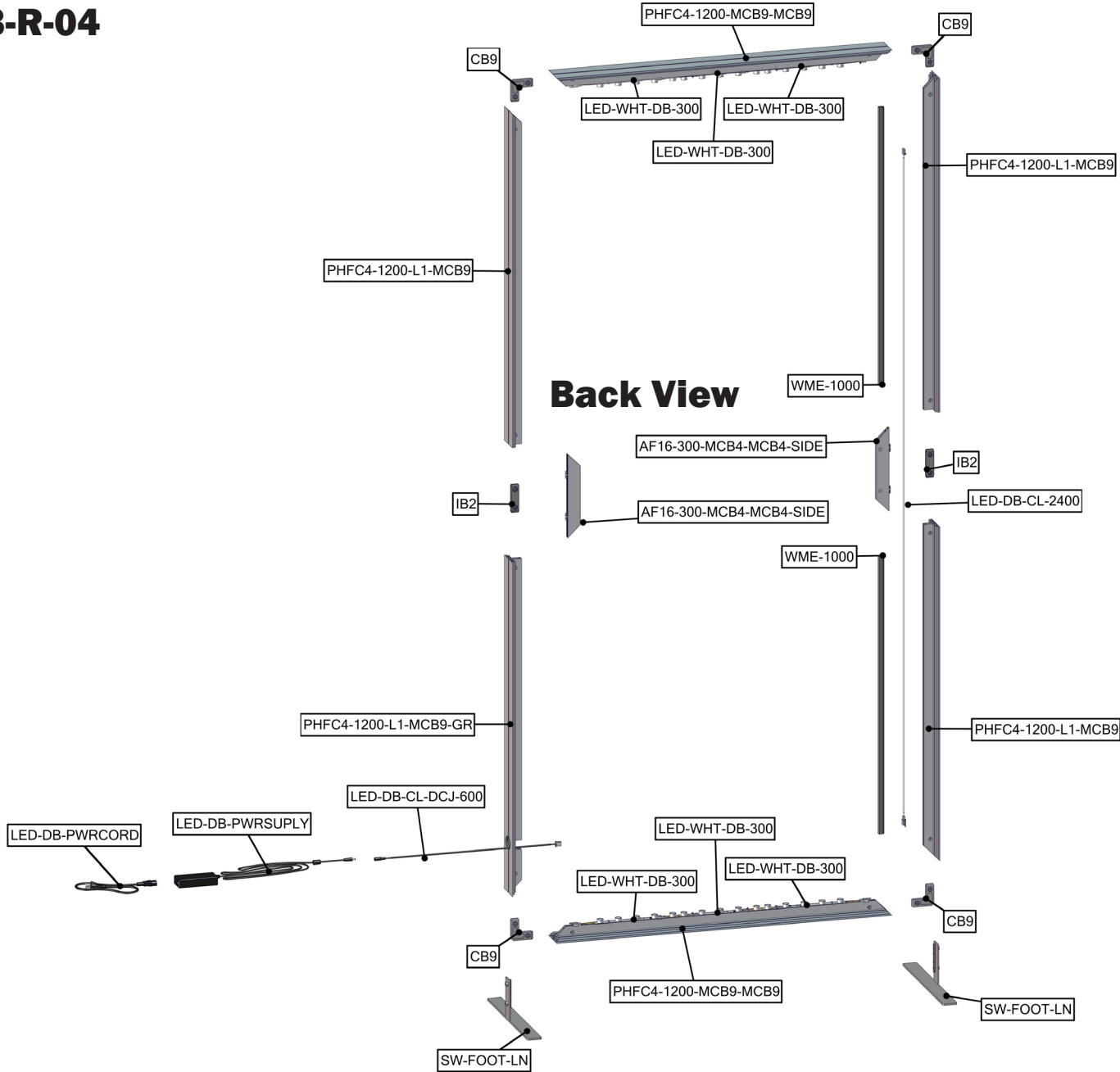

Internal Lighting Setup

VF-LB-R-04

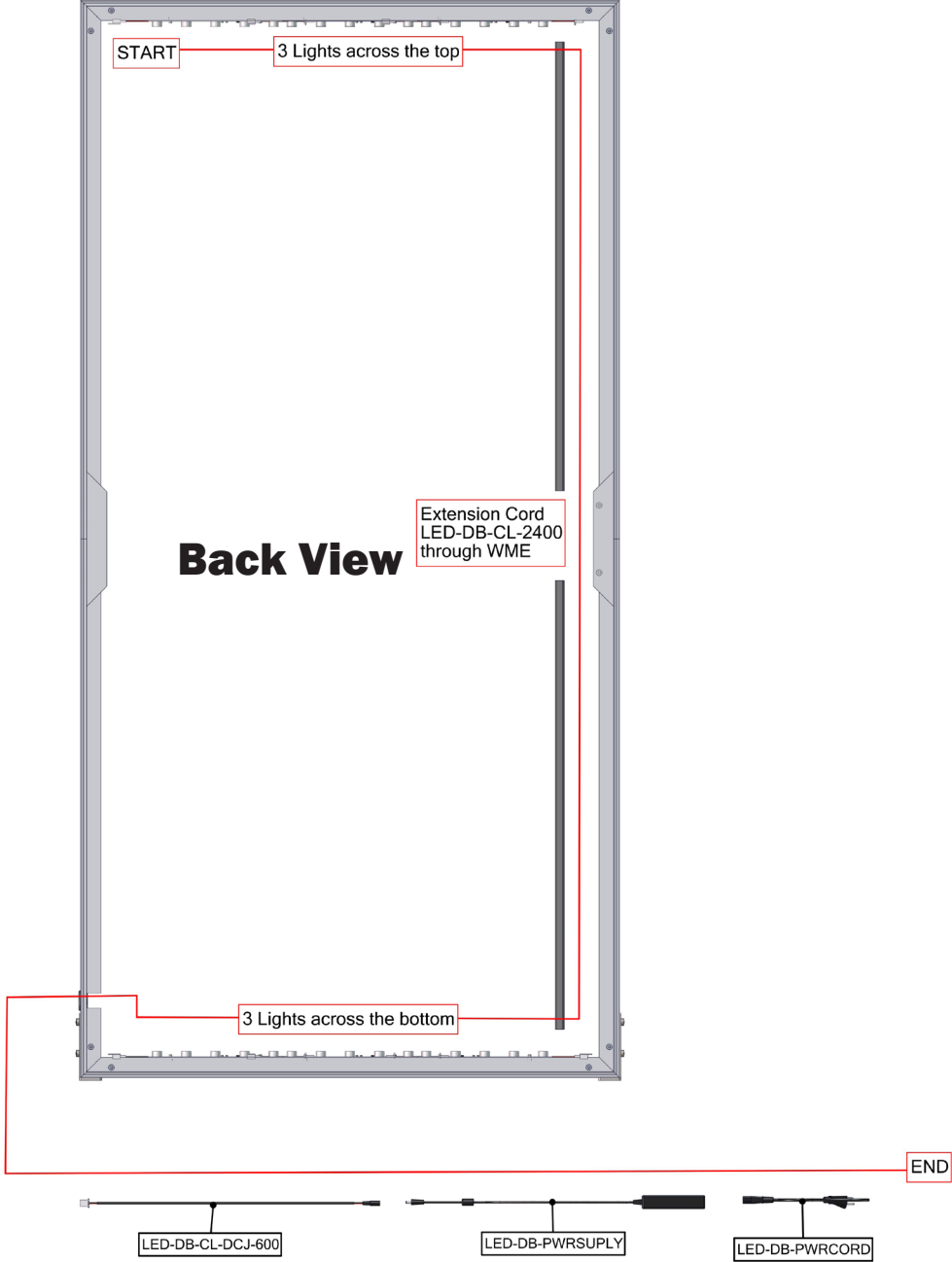

Connection Methods

Extrusion based structures use a number of different yet simple connection methods. Your kit will include one or more of the connection methods shown below. Steps within the Kit Assembly will reference a specific method for each connection point.

Connection Method 1: Cam Lock / Slide Lock

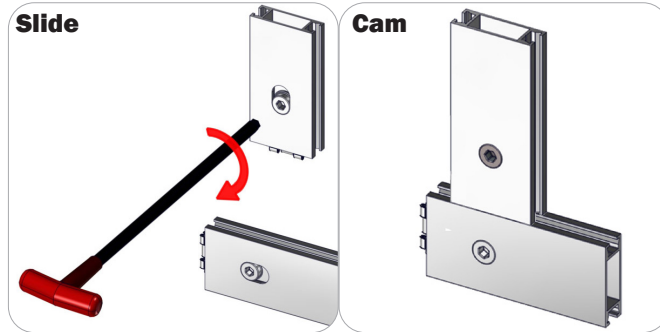

A cam lock equipped extrusion can lock to any cam lock channel. With the cam lock unlocked, set the teeth of the cam lock into the desired position on the cam lock channel. Using your allen key tool, carefully turn the lock clockwise to lock in place. Be sure to lock securely, but do not over tighten.

A slide lock equipped extrusion can also lock into any cam lock channel. When the slide lock is unlocked, pull back on the hex bolt head to retract the slide lock into the body of the extrusion. Slide locking procedure is the same as a cam lock.

Connection Method 2: IB2 / Corner Brackets

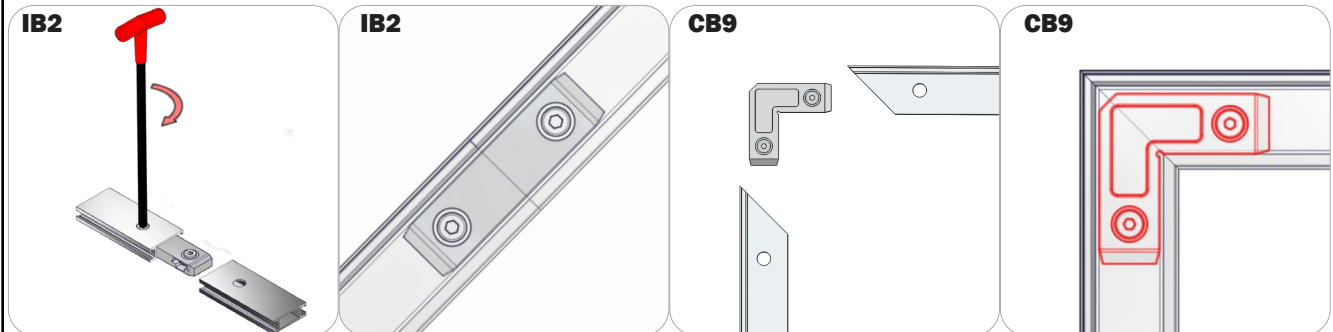

Press the hex bolt head in with your thumb and slide the extrusion and connector together so that the hex bolt head sits into the lock hole. Repeat with the second extrusion to the free end of the connector. Lock the extrusions together by turning carefully with the allen key tool. Be sure to lock securely, but do not over tighten.

Connection Method 3: SW-FOOT

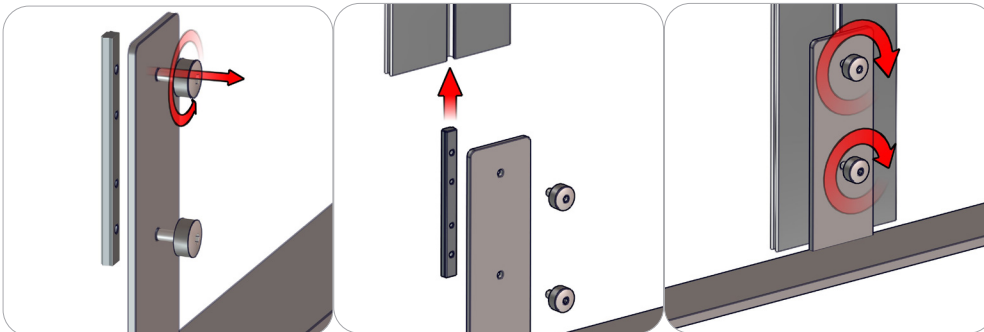

An SW-FOOT assembly consists of two thumb screws, an LN100, and SW-FOOT baseplate. Start by loosening the thumb screws (it is best not to completely remove the screws). Slide the extrusion onto the LN100 by utilizing its back cam channel. When the extrusion rests on baseplate or ground (depending on application), tighten the thumb screws to lock in place. Do not over tighten.

Connection Method 4: Internal Lighting Setup

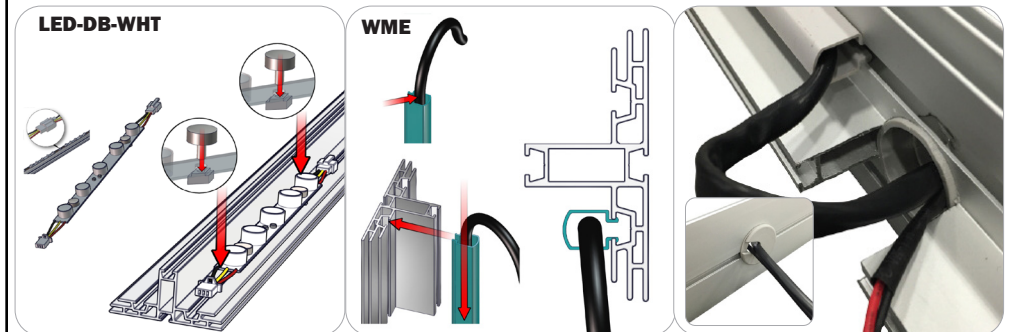

Be sure to fully assemble all frames before using the internal lighting components. With the thumbscrews loosened, place the light strips on the frame, then hand tighten them in series, male to female connections with extension cords. Do not over tighten the thumbscrews. Snap on the wire management extrusions with the power cord extensions in place. Reference the Internal Lighting Diagram for more details.

Kit Assembly

Step by Step

Step 1.

Gather the components necessary for assembling your light box frame. Assemble in the order the Exploded View instructs. Connect the AF16's on the middle channel for single sided graphics and on the farthest back channel for double sided graphics.

Refer to Connection Methods 1 and 2 for additional information.

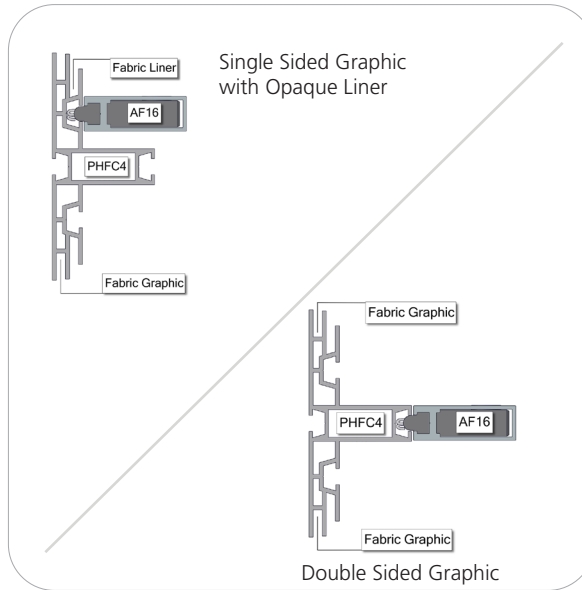

Step 2.

Gather the components necessary for the Internal Lighting assembly to your light box. Assemble in the order the Exploded View and the Internal Lighting Setup Diagram instructs.

Refer to Connection Method 4 for additional information.

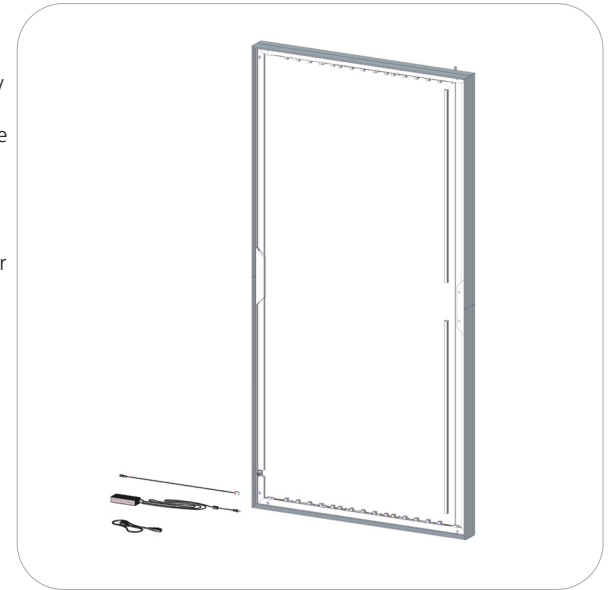

Step 3.

Locate your silicone edge graphic and opaque liner. Push the silicone edges of the graphic panel into the primary grooves of the PHFC4 extrusion perimeter. Push the silicone edges of the opaque liner into the secondary grooves of the PHFC4 extrusion perimeter.

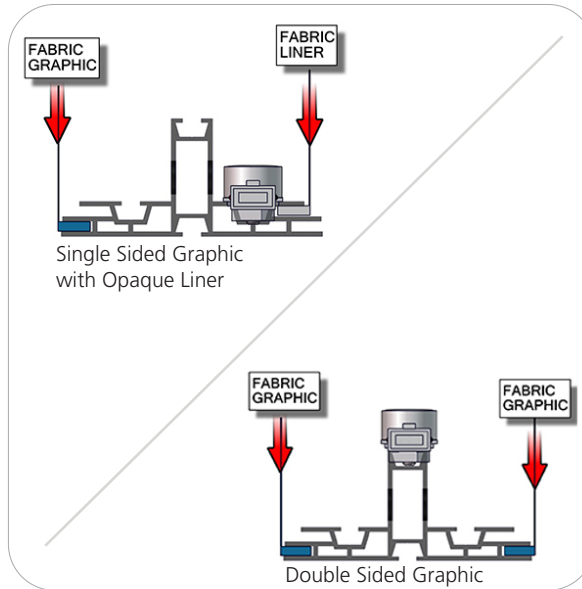

Step 4.

Gather the components necessary for assembling your frame stabilizing bases. Assemble in the order the Exploded View instructs.

Refer to Connection Method 3 for additional information.

Setup Complete.

