

Formulate Bar Counter 06

Formulate counters couple lightweight hardware with state-of-the-art printed stretch silicone edge push-fit fabric graphic to create funky and functional reception stands.

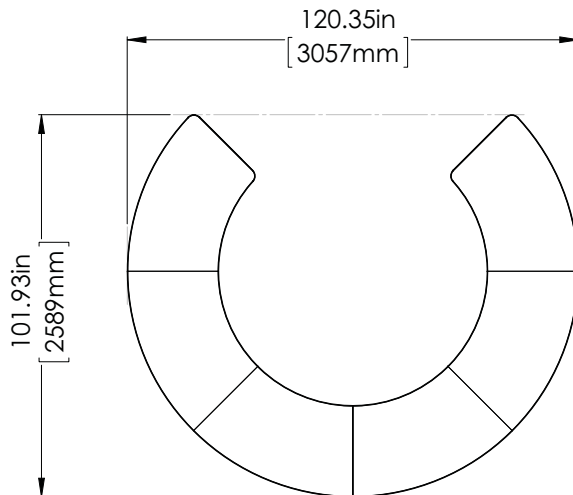

We are continually improving and modifying our product range and reserve the right to vary the specifications without prior notice. All dimensions and weights quoted are approximate and we accept no responsibility for variance. E&OE. See Graphic Templates for graphic bleed specifications.

features and benefits:

- Premium aluminum tube frames with cam lock assembly
- Easy to store and ship
- Counter top and base (come in a variety of colors)
- One push-fit fabric graphic
- Lifetime limited hardware warranty against manufacturer defects

dimensions:

Hardware	Graphic
Assembled unit: 120.35"w x 37.8"h x 101.93"d 3057mm(w) x 960mm(h) x 2589mm(d)	Refer to related graphic template for more information.
Approximate weight with cases: 378 lbs / 172 kgs	Visit: www.tradeshowplus.com

Shipping

Packing case(s): 3 OCFM	additional information:
Shipping dimensions: 38"l x 26"h x 14"d 965mm(l) x 660mm(h) x 356mm(d)	Graphic material: dye-sublimation push-fit fabric graphic
Approximate total shipping weight (includes cases & graphics): 384 lbs / 174 kgs	Counter top Dimensions: 24" depth Inside Radius 2' Outside Radius 5'
	Counter top Max Weight Capacity: 45 lbs.

Wood Finish Options



2 person assembly recommended:



Included In Your Kit

Tools, Components, & Connectors



CT-W-06-C-01 x1



CT-W-06-C-02 x1



CT-W-06-C-03 x4



BASE-W-06-C-01 x1



BASE-W-06-C-02 x1



BASE-W-06-C-03 x4



TRI30-COUNTER x6



SET-SCREW-5-16-2 x36



FLANGE-WING-NUT-5-32 x36



ROTO-HEX-KEY x1



T-HANDLE-5-32 x1

Graphics

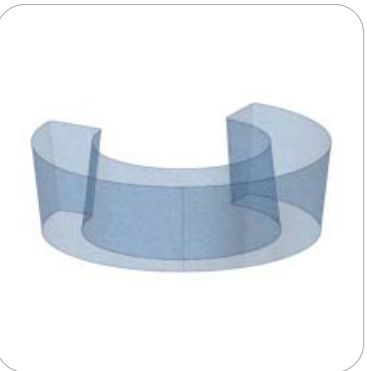

W-06-C-06-G x1

Exploded View

W-06-C-6

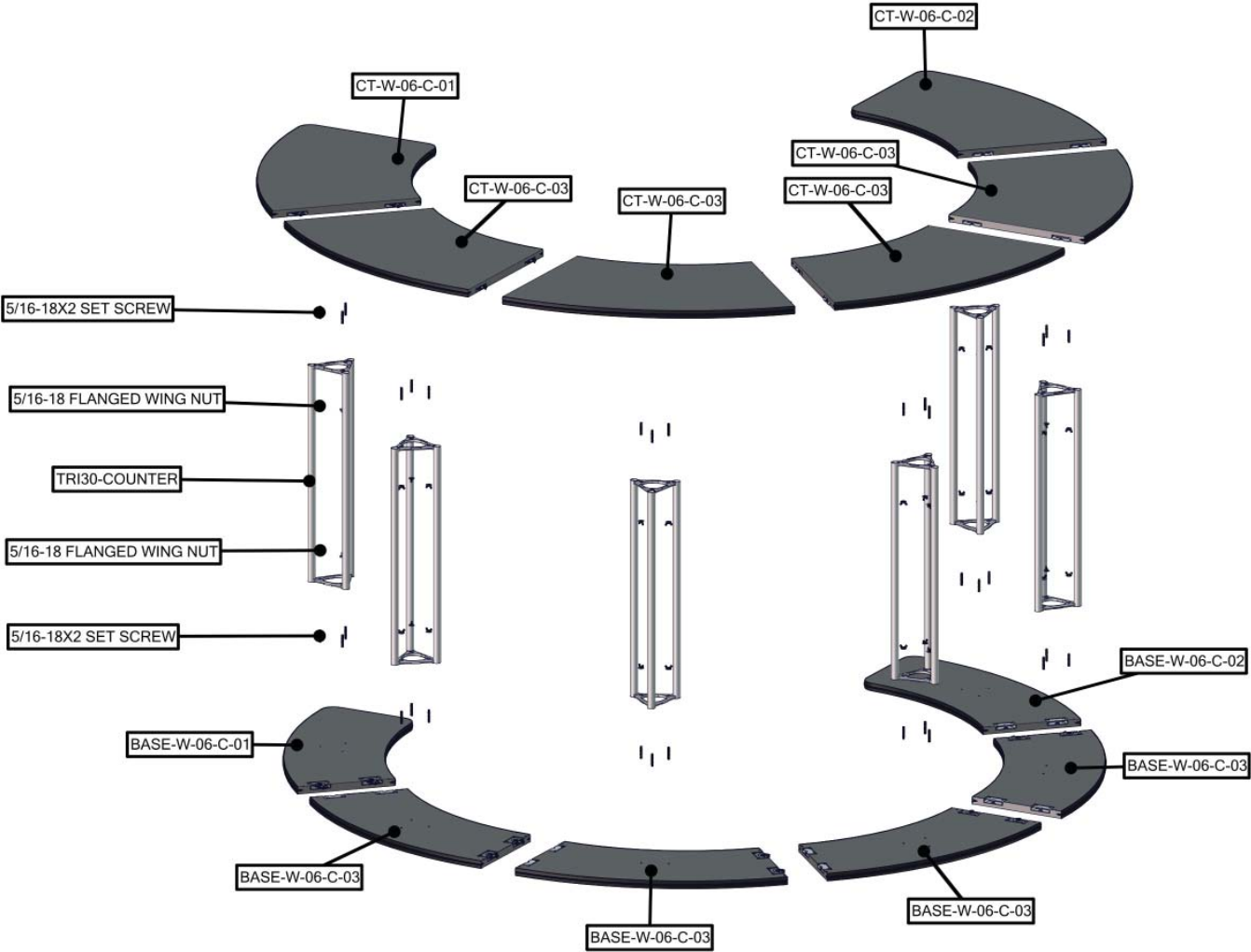

Kit Assembly

Step by Step

Step 1.

Locate your counter bases and position them together. Lock them together using the locking mechanisms on the top side of the bases. You will need your L-shaped allen key to do so.

Reference the Exploded View for more information.

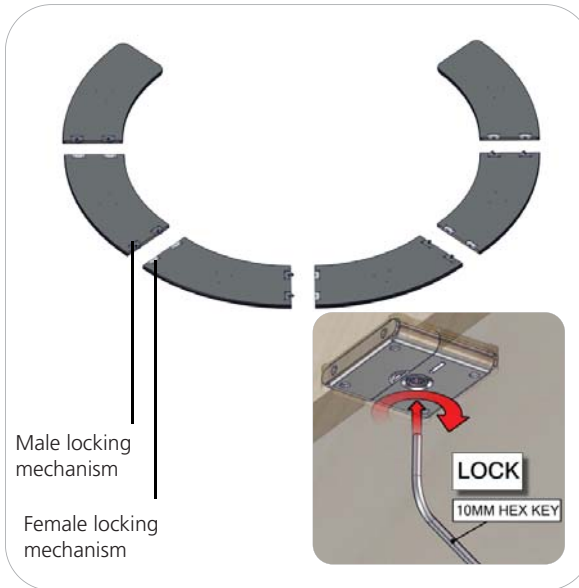

Step 3.

Locate your counter tops and fastening hardware. Starting from one end, hand tighten the truss on to the counter tops with your T-Handle and lock the tops together using your L-shaped allen key.

Reference the Exploded View for more information.

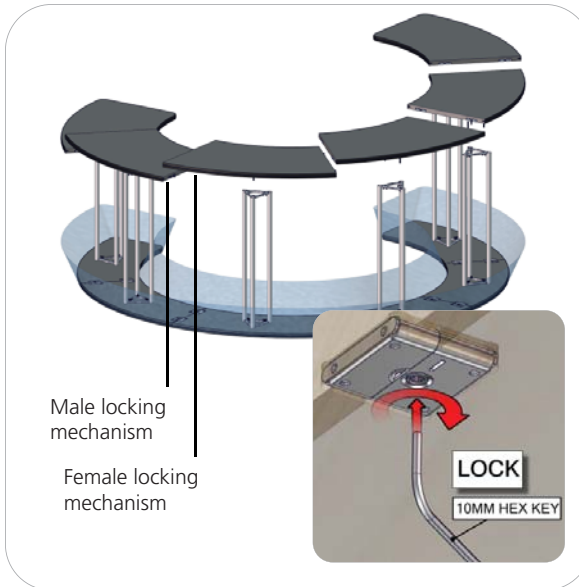
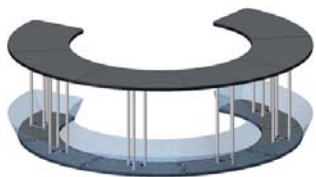

Step 2.

Locate your triangular truss and fastening hardware. Hand tighten the truss onto the bases with your T-Handle allen key. Locate your silicone edge graphic. Push the silicone edges into the grooves of the counter base assembly.

Reference the Exploded View for more information.

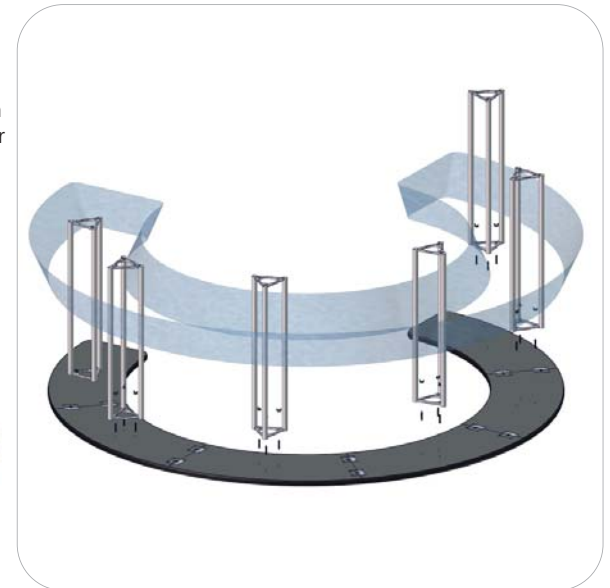
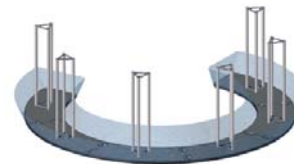

Step 4.

Pull up your silicone edge graphic. Push the silicone edges into the grooves of the counter top assembly. Zipper is located on center of inside curve for convenient counter access and storage.

Setup is complete.

