

# Formulate Backlit Charging Tower

The Formulate Charging Tower adds technology and great value for visitors in need of a quick charge. Excellent for retail applications, trade shows and events.



## features and benefits:

- Features 16 high-speed charging tips: (8) Micro USB for Android devices and (8) Apple 8-pin for Apple iPhone/iPad/Lightning devices
- Features a circular fabric header for branding and an illuminated fabric center structure
- Base and tabletop color offered in choice of four thermoform color options
- Lifetime limited hardware warranty against manufacturer defects

## dimensions:

Hardware	Graphic
<p>Assembled unit: 33.56" w x 86.81" h x 33.46" d 852mm(w) x 2205mm(h) x 850mm(d)</p> <p>Approximate weight with cases: 161 lbs / 73 kgs</p>	<p>Refer to related graphic template for more information.</p> <p>Visit: <a href="http://www.tradeshowplus.com">www.tradeshowplus.com</a></p>
Shipping	
<p>Packing case(s): 1 OCFM Case</p> <p>Shipping dimensions: OCFM: 138" w x 17" h x 15" d 3505mm(w) x 429mm(h) x 381mm(d)</p> <p>Approximate total shipping weight (includes cases &amp; graphics): 165 lbs / 74.8 kgs</p>	
additional information:	
<p>Graphic material: dye-sublimation zipper pillowcase fabric</p>	

We are continually improving and modifying our product range and reserve the right to vary the specifications without prior notice. All dimensions and weights quoted are approximate and we accept no responsibility for variance. E&OE. See Graphic Templates for graphic bleed specifications.

# Included In Your Kit

Tools, Components, & Connectors

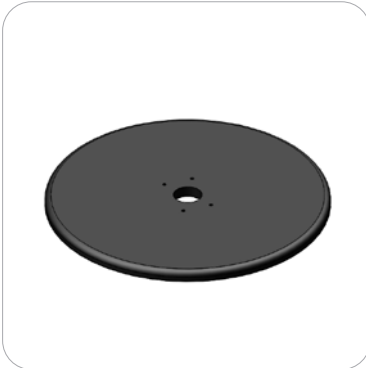

FMLT-CHRG-01-BASE x1

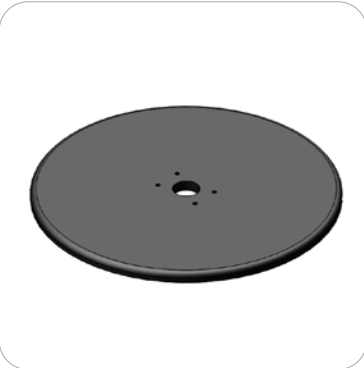

FMLT-CHRG-01-TOP x1



FMLT-CHRG-01-SOFFIT x1



WIRE CAP x1



SET SCRW 5/16x18x2 x4



TOP BOLT 5/16x18x2 x4

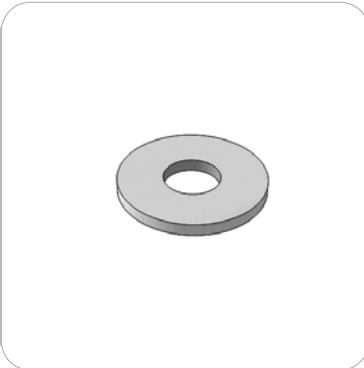

WASHER x4



5/16-18 FLANGE WINGNUT x12



CHRG-QUAD-TRUSS x2

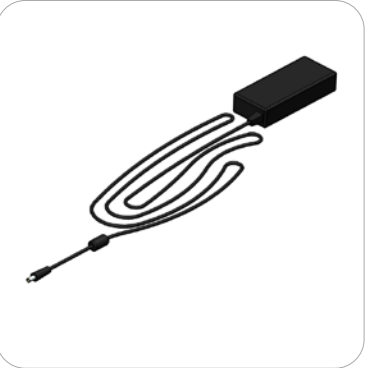

LED-DB-PWRSUPPLY x1

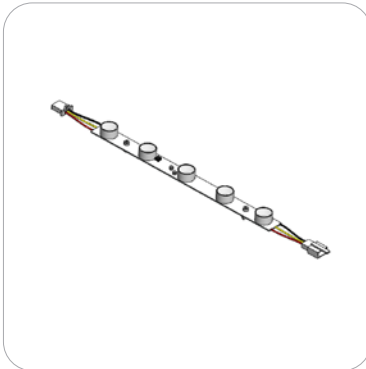

LED-WHT-DB-300 x8



LED-DB-PWRCRD x1



LED-DB-CL-300 x3

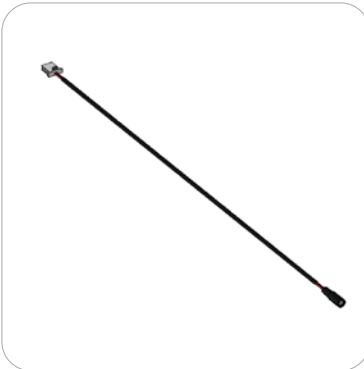

LED-DB-CL-DCJ-600 x1



MID BOLT 5/16x18x3-1/2 x4

# Included In Your Kit

Tubes



CHRG-01-FS-T1 x3



CHRG-01-FS-T2 x2

Graphics

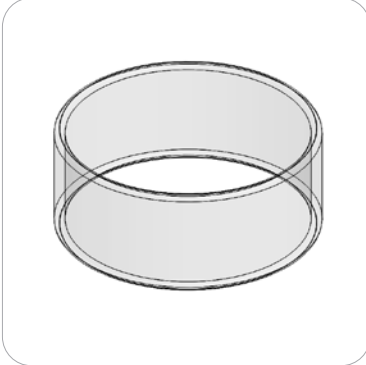

CHRG-01-FS-G x1

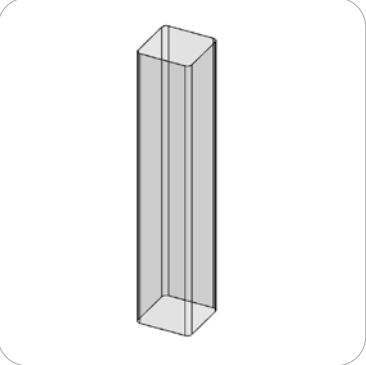

CHRG-01-G x2

Additional Components



USB CABLE x4



USB HUB x4

# Exploded View

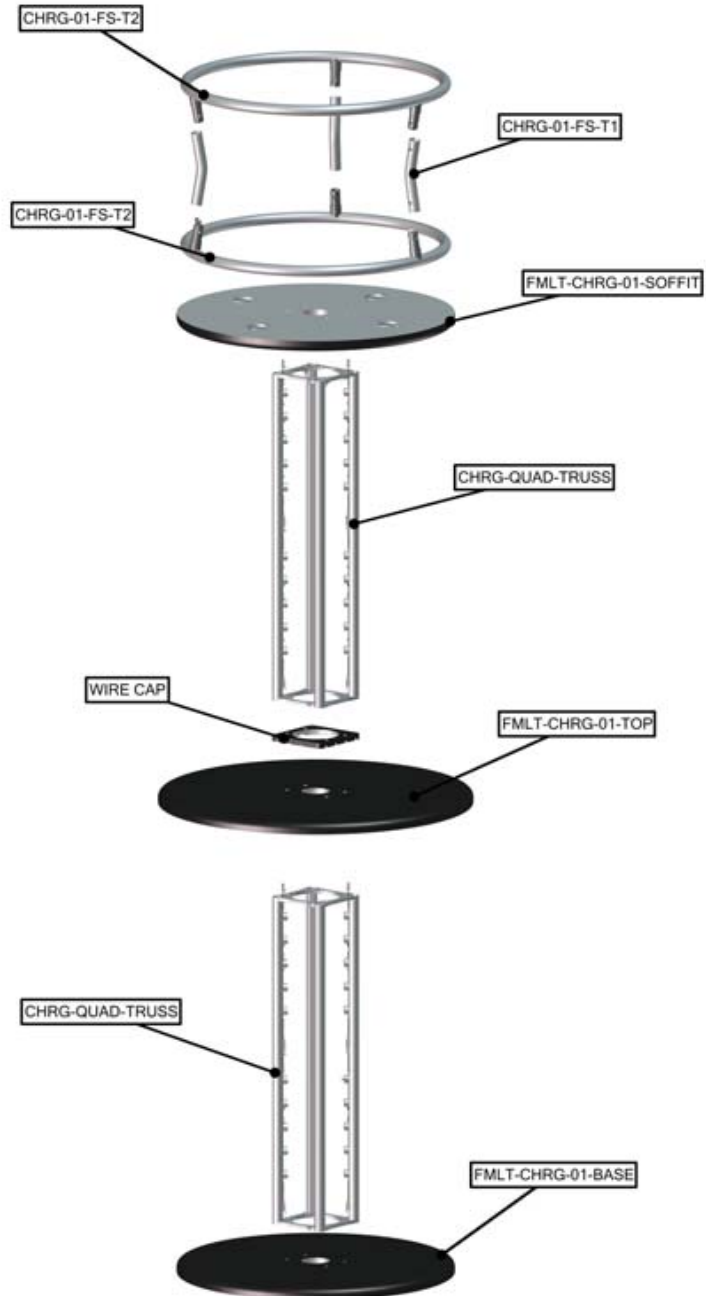

# Labeling Diagram

FMLT-CHRG-01

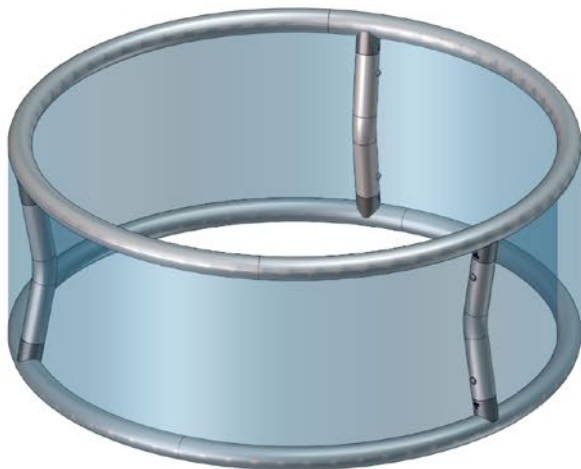
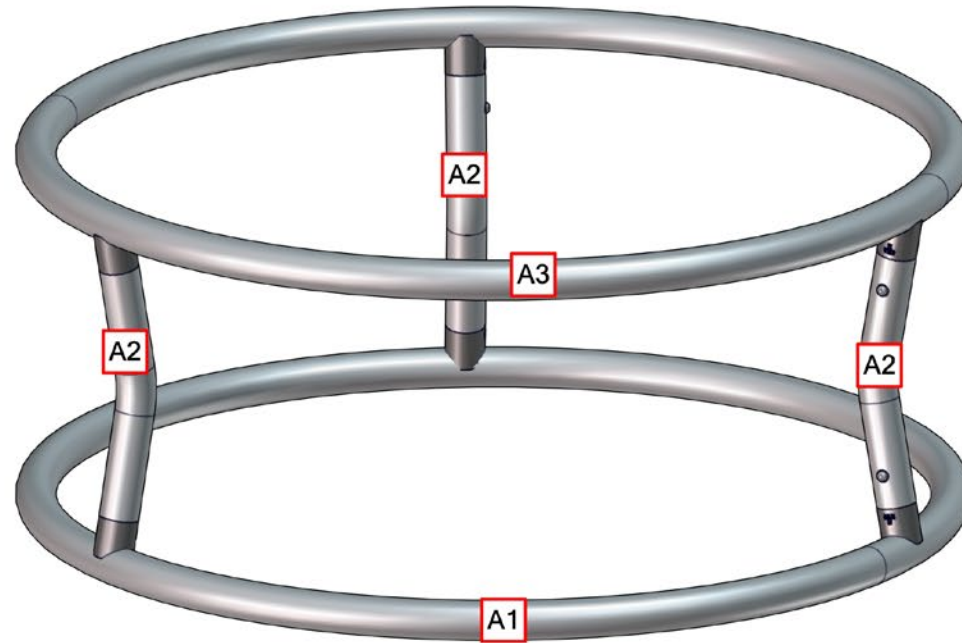

**OVERVIEW**

# Connection Methods

Formulate® structures use a number of different yet simple connection methods. Your kit will include one or more of the connection methods shown below. Steps within the Kit Assembly will reference a specific method for each connection point.

## Connection Method 1: ES30 / ES50 / ES75

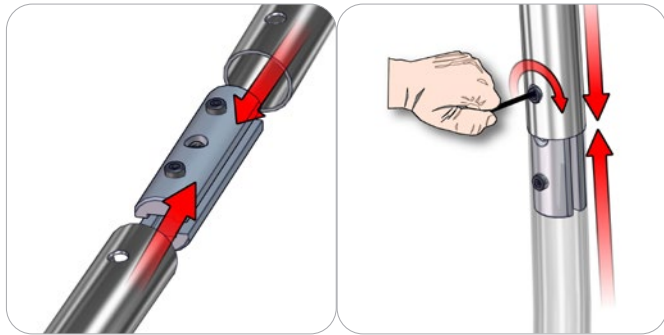

Compress the unlocked connector and slide one tube onto each end. Lock both screws carefully using your allen key tool. Be sure to lock securely, but do not overtighten.

## Connection Method 2: Snap Buttons & Swage

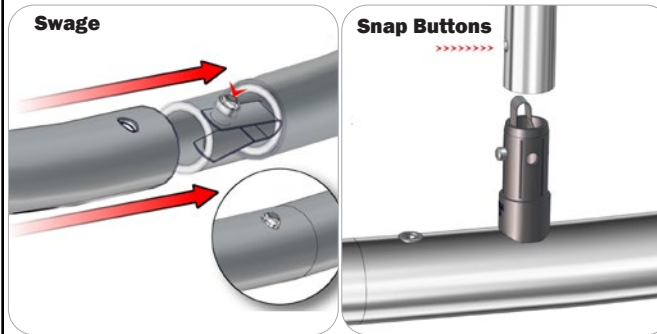

Locate the snap button on the connector or swage tube. Locate the hole on the corresponding tube. Press the snap button with your thumb and slide the tube and connector together so that the snap button snaps fully into the lock hole. To disassemble, press the snap button and pull apart.

## Connection Method 3: ES30-90B / ES30-I / ES30-C

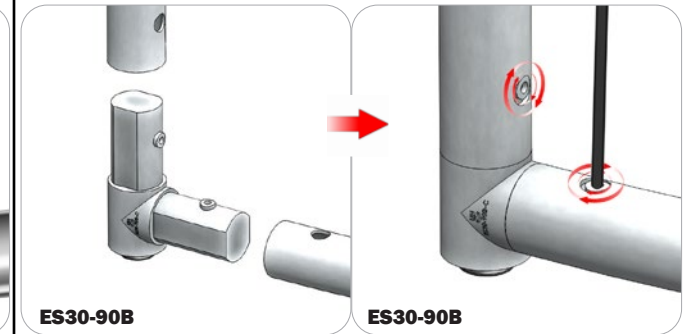

Compress one unlocked end of the connector and slide it through one tube end. Compress the other end of the connector and slide the second tube on. Lock both screws carefully using your allen key tool. Be sure to lock securely, but do not overtighten.

## Connection Method 4: Tube Clamps

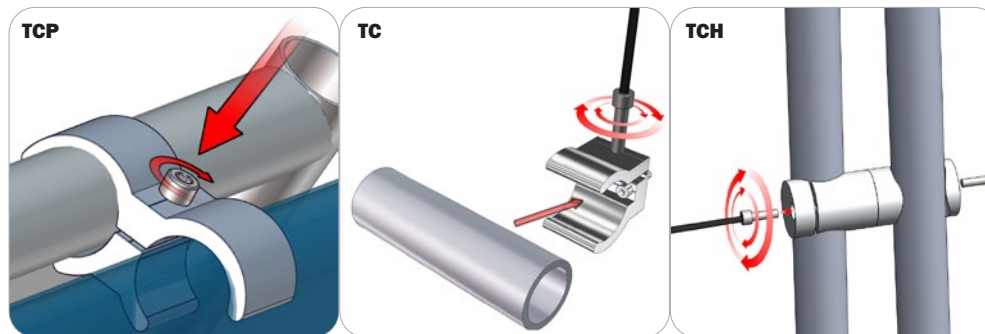

Be sure to fully assemble all frames before using clamps. With the clamp unlocked, place one tube of the first frame into the mouth of the clamp. Place the second tube (if applicable) into the second mouth of the clamp. With both frame's tubes in the clamp, be sure to lock securely, but do not overtighten.

# Kit Assembly

## Step by Step

### Step 1.

Place your base onto the floor in correct orientation. Place your Quad Truss onto the base so that the four holes in the truss line up with the holes on the base. Use (4) SET SCRW 5/16x18x2 and (4) 5/16-18 FLANGE WINGNUTS to lock the truss into place.

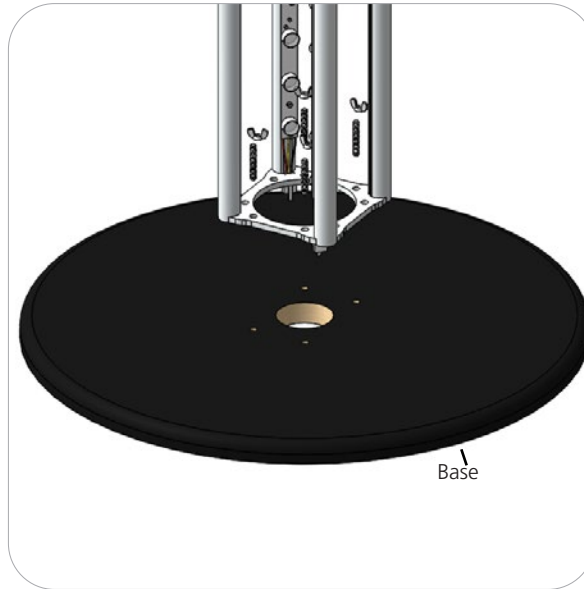

### Step 2.

Locate your counter top. Align your counter top so that the four holes on the bottom line up with the holes on the quad truss.

\*Note: the counter top should not be fastened to the truss yet.

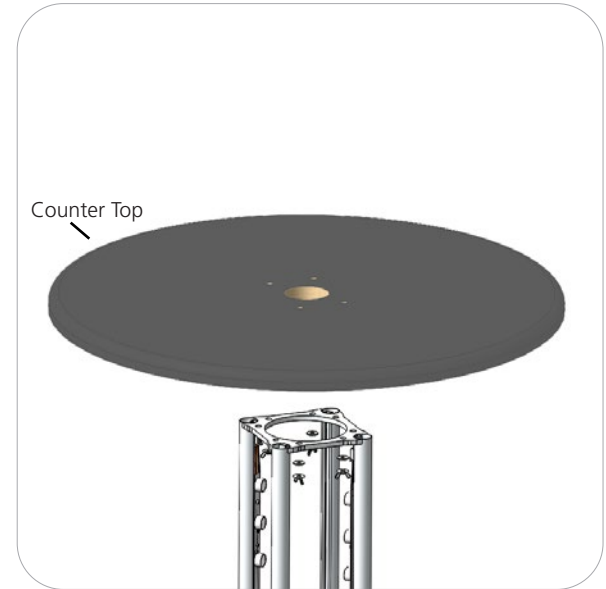

### Step 3.

Thread your usb cable(s) through the center of the counter top. Set your usb cables individually through each groove of the USB Cap. Align the cap so that all four screw holes match with the counter top holes and truss beneath.

\*Note: the counter top should not be fastened to the truss yet.



### Step 4.

Gather your second Quad Truss, (4) MID BOLT 5/16x18x3-1/2, and (4) 5/16-18 Flange Wing nuts. Align your Quad Truss so that the holes match the components below it. Thread your bolts through the top, tighten the Wing Nuts from the bottom.

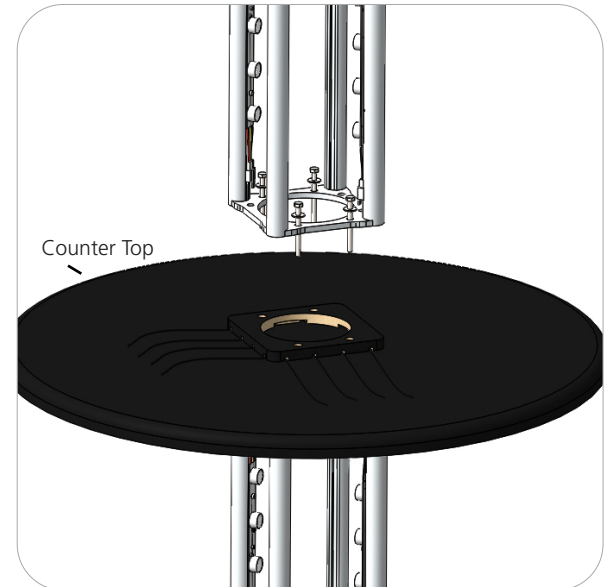
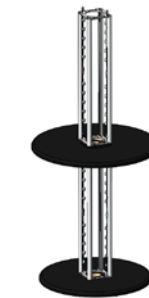



# Kit Assembly

## Step by Step

### Step 5.

Locate your FMLT-CHRG-01-SOFFIT counter ceiling. Align the holes in the soffit so that they match with the holes in the Quad Truss. Use (4) SET SCRW 5/16x18x2, (4) washers, and (4) 5/16-18 FLANGE WINGNUTS to lock the truss into place.



### Step 6.

Assemble your LED-DB-PWRSUPLY by connecting it to the power cord. Thread the cable down the center holes of your counter assembly so that the power cable and power supply box are left on the top of the FMLT-CHRG-01-SOFFIT . Place your power strip on top of the FMLT-CHRG-01-SOFFIT also and thread any extension cords down the holes as well. Locate your USB Hub and connect it to your power strip. Connect all four usb cables to the four usb hubs to power them.



### Step 7.

Use your LED-DB-CL-300s to link your LEDs by connecting male to female.

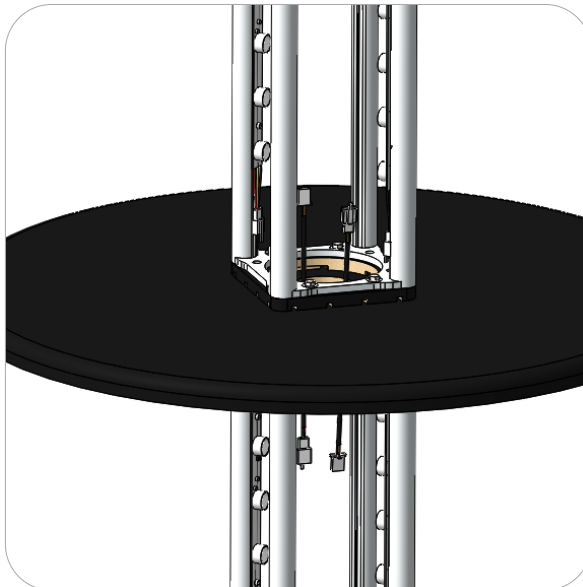
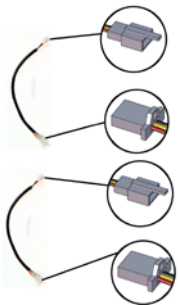

### Step 8.

You will need your LED-DB-CL-DCJ-600 to connect your LEDs to the power supply. Route the cable through the hole in the base. Test that all LEDs illuminate.

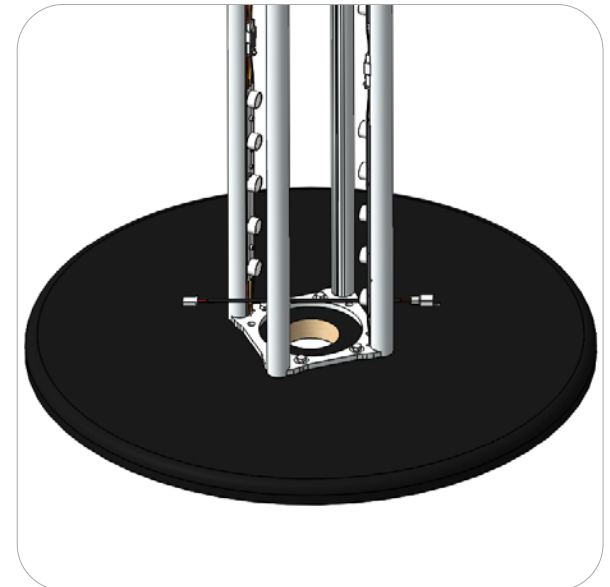
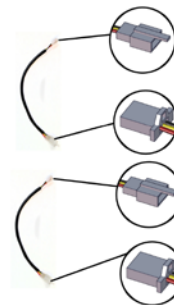



# Kit Assembly

## Step by Step

### Step 9.

Now assemble your fabric structure. Locate three CHR-01-FS-T1 and both CHR-01-FS-T2 tubes. Snap the T1 tubes onto the T2 so that the curved side faces toward the inside of the structure.

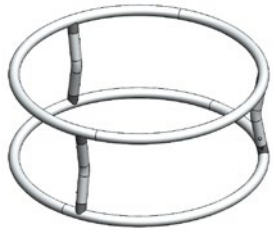

### Step 10.

Cover your tube structure from bottom to top and zip to enclose.



### Step 11.

Place your fabric structure on top of the SOFFIT to hide the wiring.



### Step 12.

Locate your CHR-01-G graphics. wrap your Quad Truss and zip. Rotate the graphics so that the zippers are uniform to one corner of the truss. Setup is complete.

