

Formulate Arch 06

Formulate 12.5ft tall Arch 06 adds dimension, structure and design to any event or interior space! Formulate 12.5ft Arch 06 couples aluminum tube frames with stretch, pillowcase fabric graphics to create a dynamic exhibit structure. Arch 06 spans 17' wide and over 5' deep. Formulate architectural structures are made in the USA and collapse to a fraction of their size. Arch 06 packs easily into two wheeled cases for easy storage and transport.

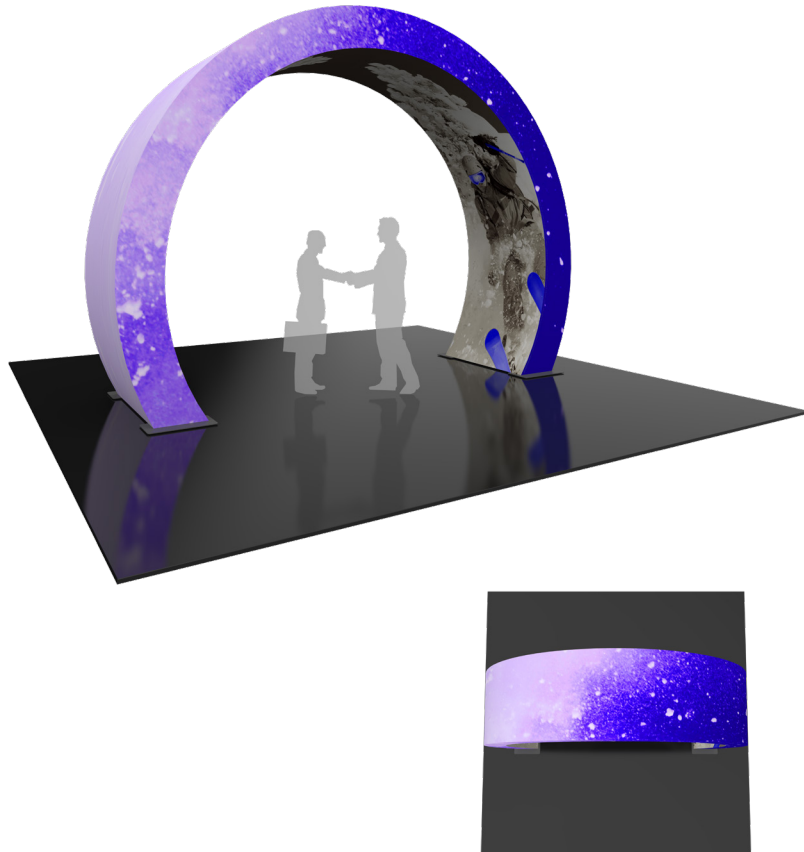

features and benefits:

- State-of-the-art 50mm curved aluminum tube frame with expanding spigots
- Pillowcase fabric graphic stretches over the frame and zips at the bottom of the arch
- Easy to store and ship
- Quick to set up
- Includes carry bag or case
- Lifetime hardware warranty against manufacturer defects
- Kit includes frame, dye-sublimated zipper pillowcase graphic and two wheeled molded OCE-2 storage cases

dimensions:

Hardware

Graphic

Assembled unit:
204" w x 150.75" h x 63.81" d
5182mm(w) x 3830mm(h) x 1621mm(d)

Refer to related graphic template for more information.

Approximate weight:
184 lbs / 84 kg

One year warranty.

Visit:
www.tradeshowplus.com

Shipping

additional information:

Packing case(s):
2 OCE-2

Graphic material:
Dye-sublimation zipper pillowcase fabric

Shipping dimensions:
OCE-2: Expandable case length (l) may vary 40" - 66" l x 18" h x 18" d
1016-1677mm(l) x 458mm(h) x 458mm(d)

When included in a larger kit, a different packaging solution will be listed to accommodate all contents of the kit. Individual packaging no longer provided.

Approximate total shipping weight:
230 lbs / 105 kg

We are continually improving and modifying our product range and reserve the right to vary the specifications without prior notice. All dimensions and weights quoted are approximate and we accept no responsibility for variance. E&OE. See Graphic Templates for graphic bleed specifications.

Included In Your Kit

Tools, Components, & Connectors

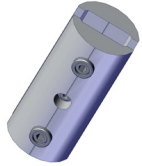

ES50 x40

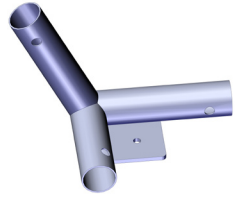

ARCH-06-T1 x2

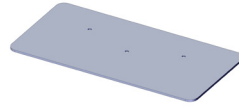

DM-PLT-BP-A-600-300 x4

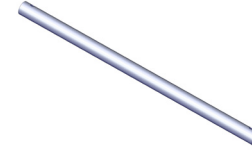

ARCH-06-T3 x4

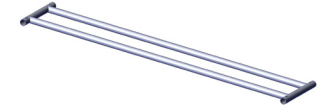

ARCH-06-T10 x6



ARCH-06-T6 x2



ARCH-06-T4 x6



ARCH-06-T5 x6



ARCH-06-T7 x2

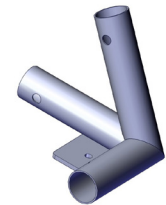

ARCH-06-T2 x2



ARCH-06-T8 x4



ARCH-06-T9 x4

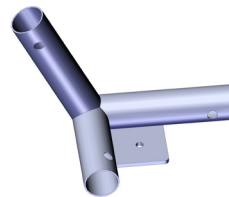

ARCH-06-T11 x2

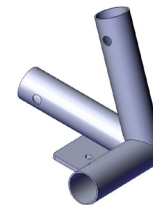

ARCH-06-T12 x2

Included In Your Kit



ARCH-06-G x1

Graphics

Exploded Diagram

ARCH-06
RIGHT BASE SECTION

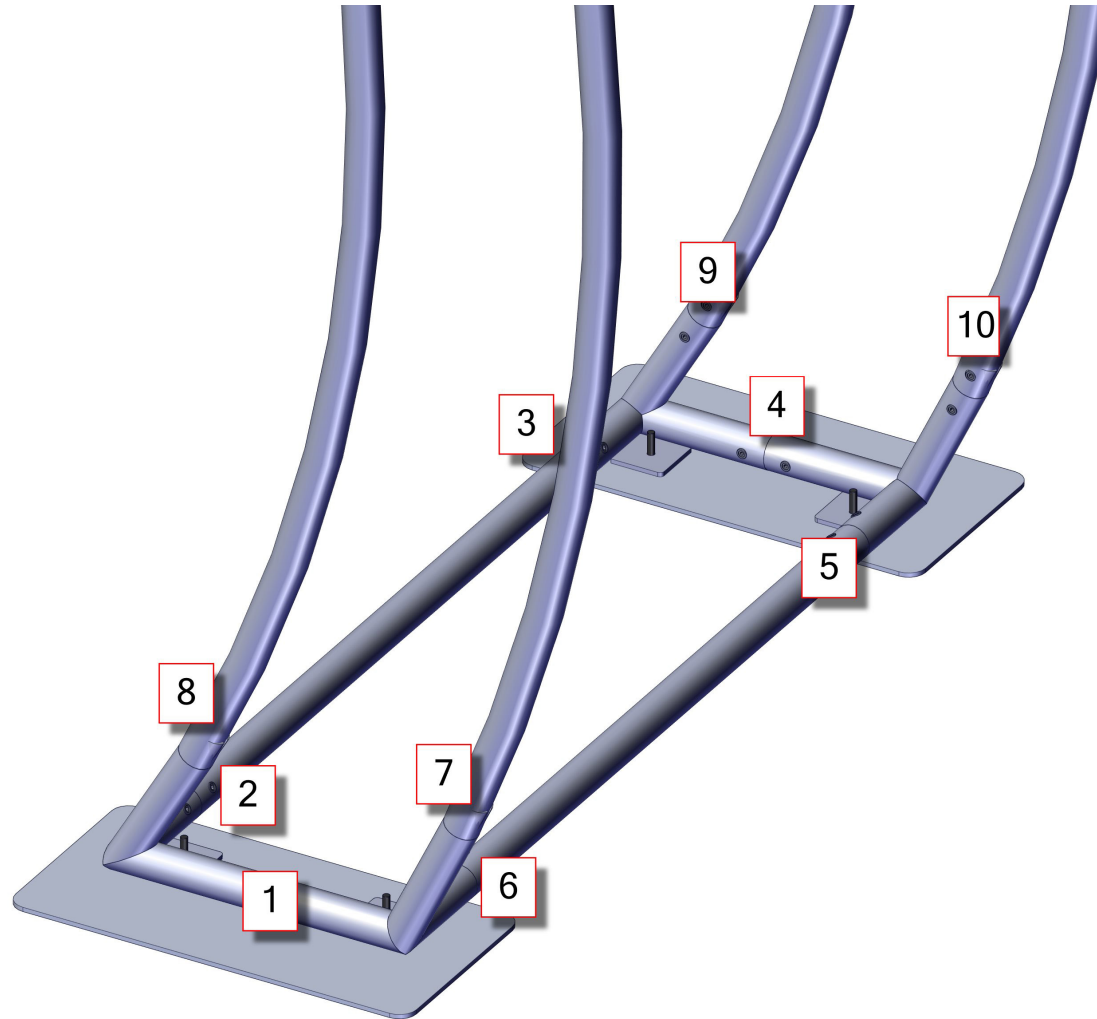

Exploded Diagram

ARCH-06
RIGHT MIDDLE SECTION

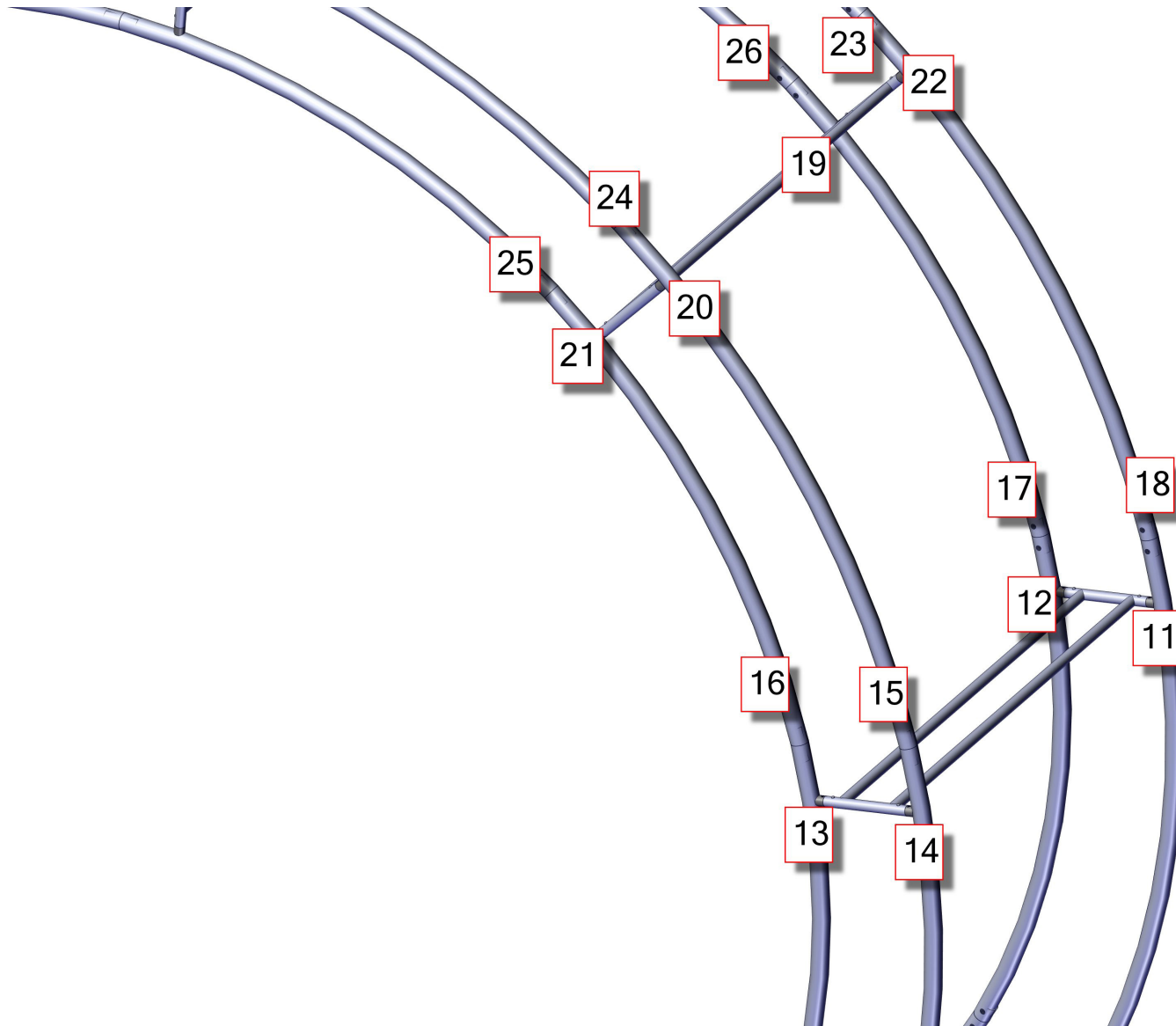

Exploded Diagram

ARCH-06

CENTER TOP FRAME SECTION

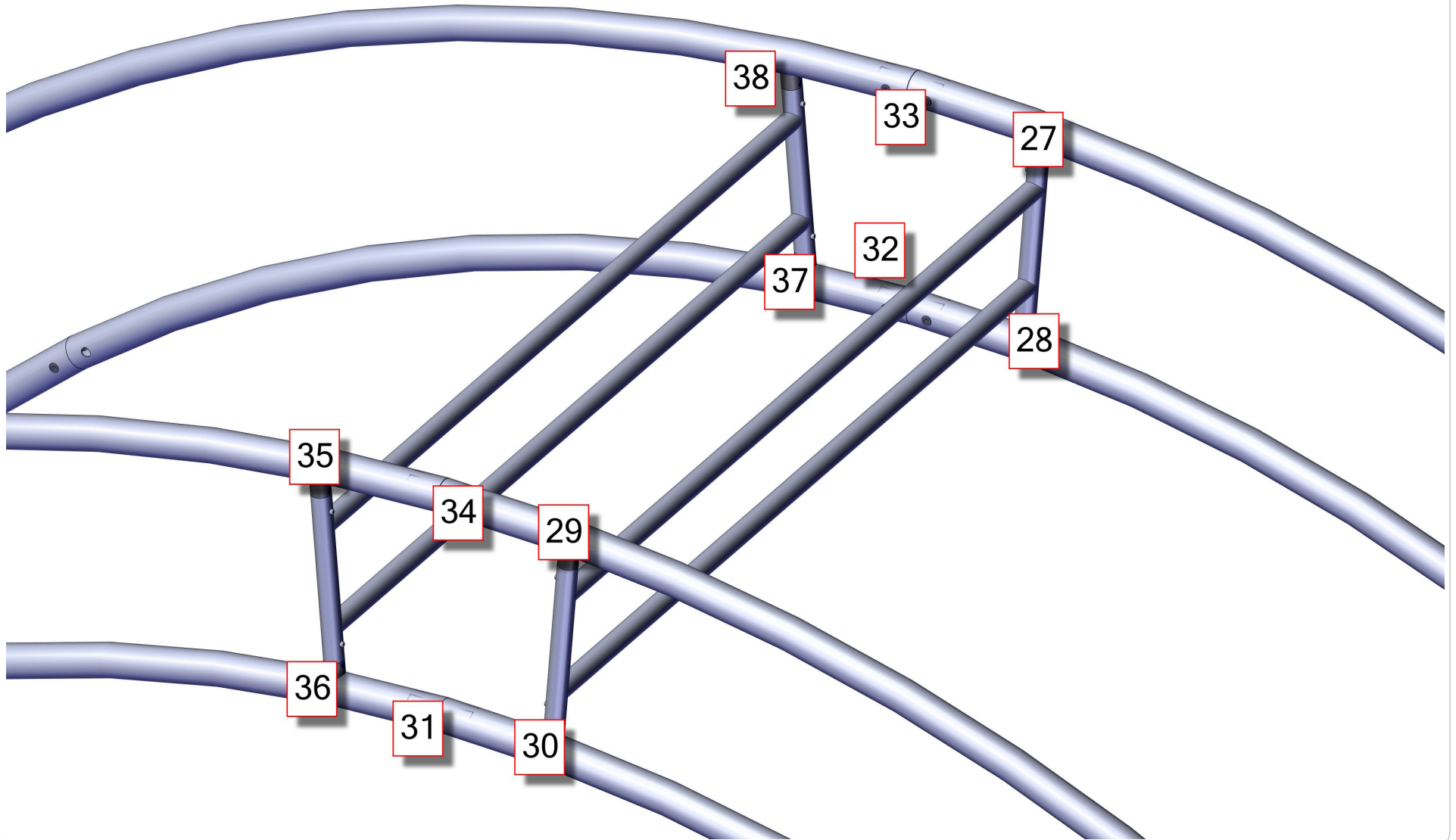

Exploded Diagram

ARCH-06
LEFT MIDDLE SECTION

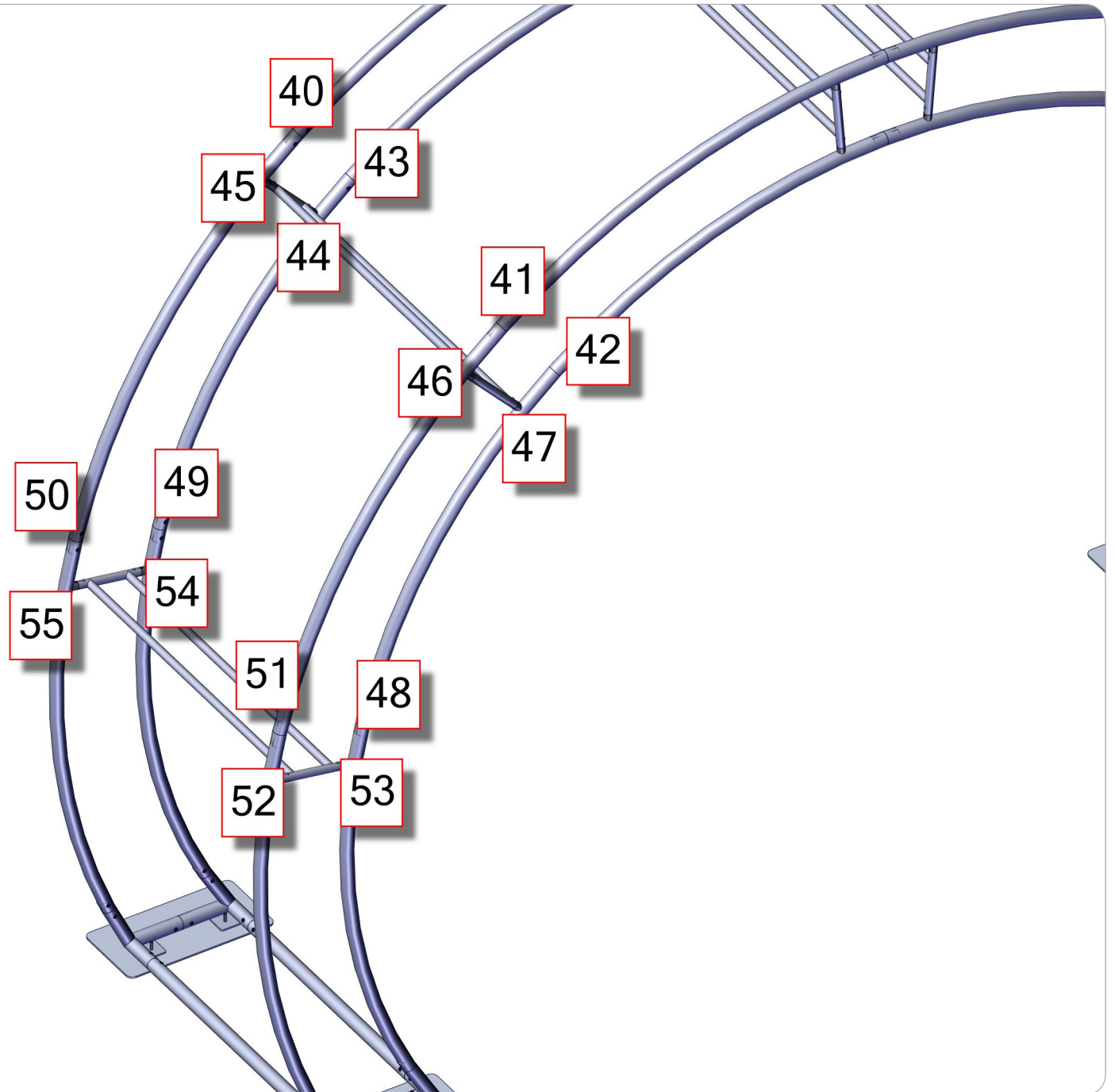

Exploded Diagram

ARCH-06
LEFT BASE SECTION

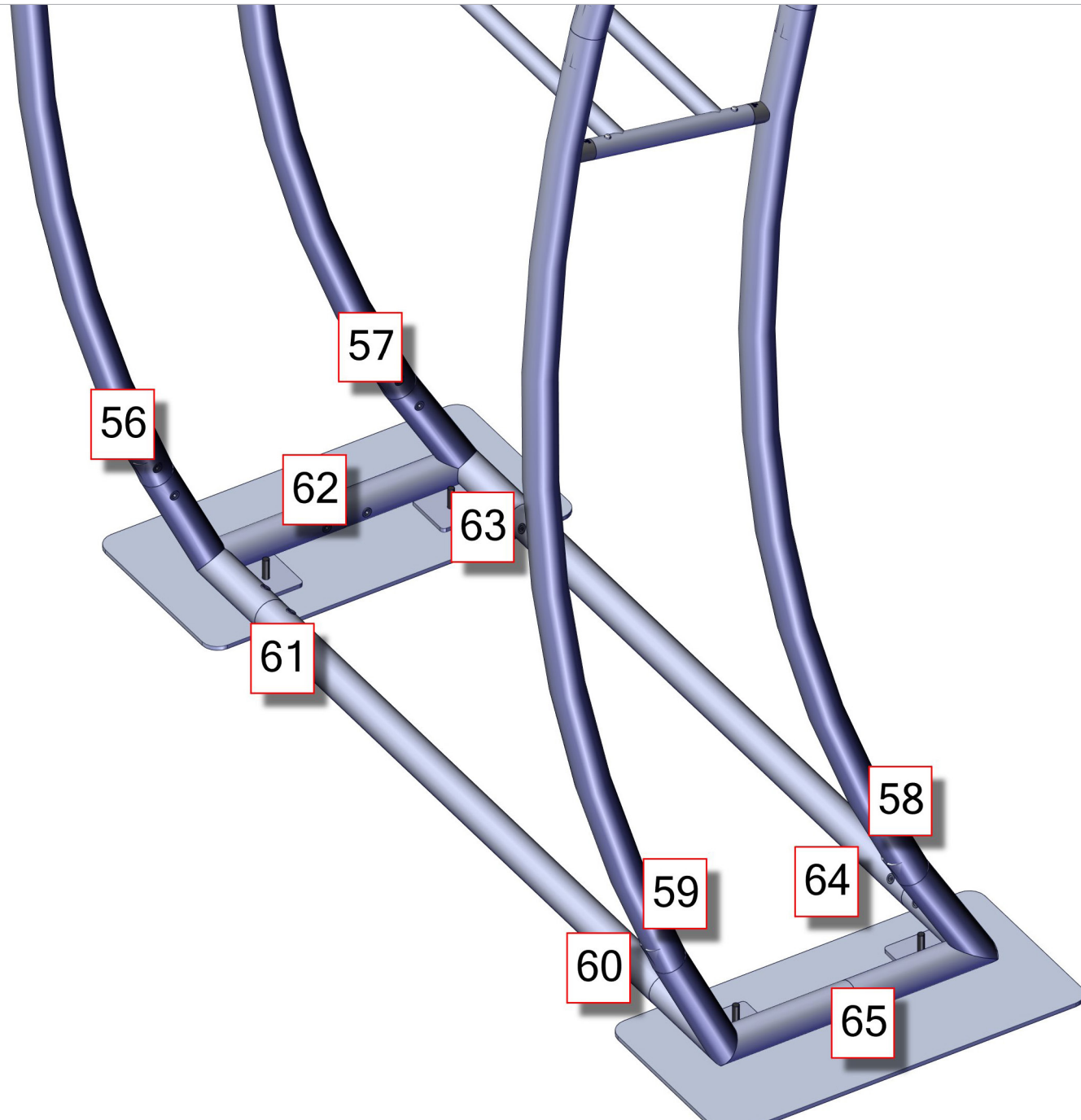

Labeling Diagram

ARCH-06

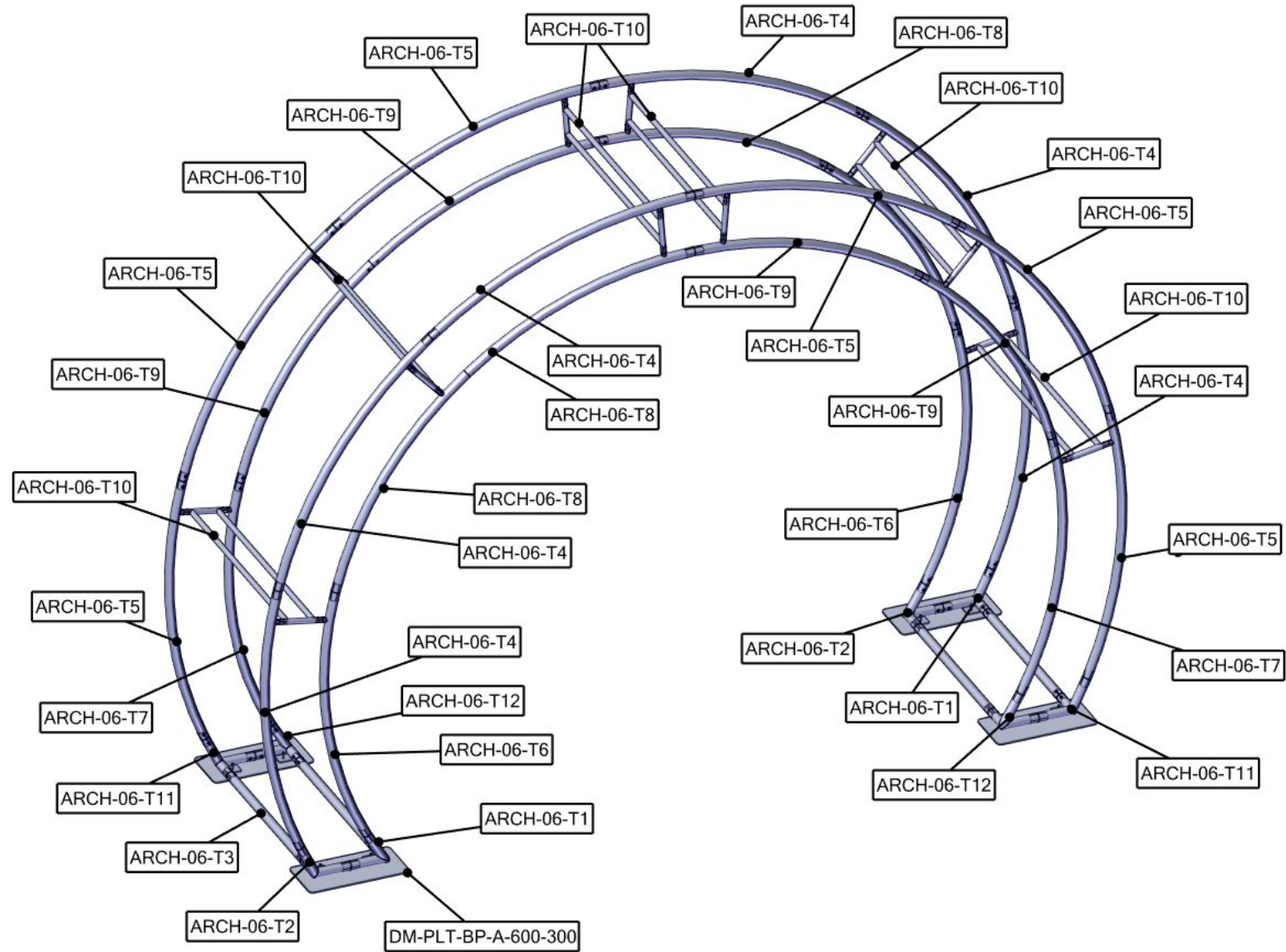

Kit Assembly

Step by Step

Step 1.

Gather the components to build the both inside frame. Use the Exploded View and the Labeling Diagram for part labels.

Reference Connection Method(s) 1 and 2 for more details.

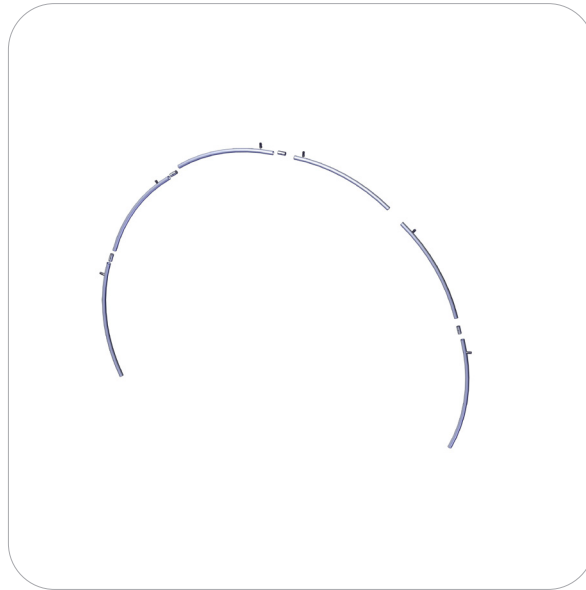
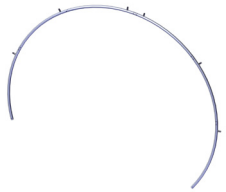

Step 2.

Gather the components to build the both outside frame. Use the Exploded View and the Labeling Diagram for part labels.

Reference Connection Method(s) 1 and 2 for more details.

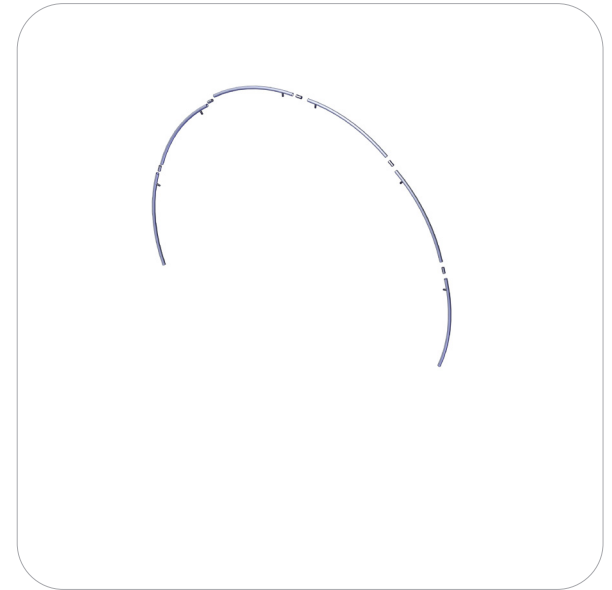

Step 3.

Gather the components to build and attach middle sections with inside frames. Use the Exploded View and the Labeling Diagram for part labels.

Reference Connection Method(s) 1 and 2 for more details.

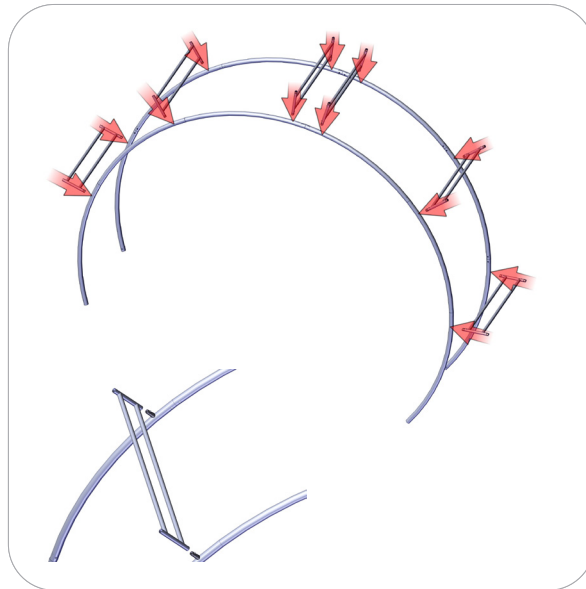
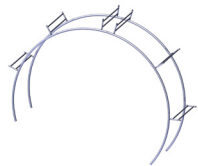

Step 4.

Gather the components to attach outside frame to structure. Use the Exploded View and the Labeling Diagram for part labels.

Reference Connection Method(s) 1 and 2 for more details.

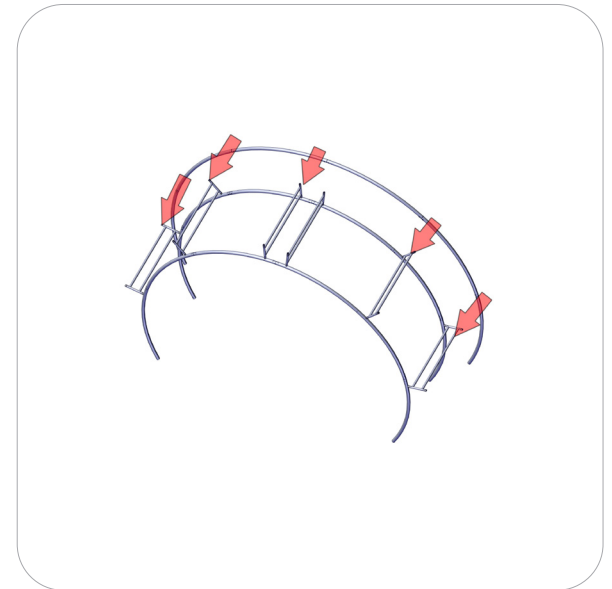
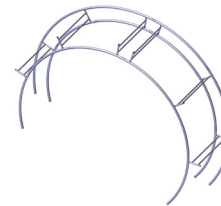

Kit Assembly

Step by Step

Step 4.

Gather the components to attach outside frame to structure. Use the Exploded View and the Labeling Diagram for part labels.

Reference Connection Method(s) 1 and 2 for more details.

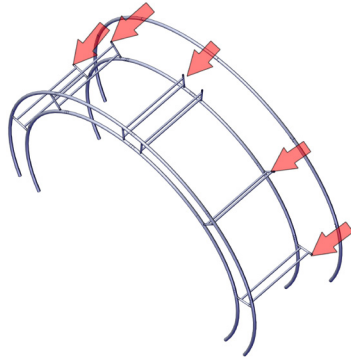
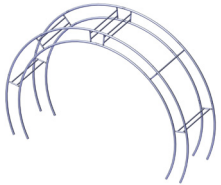

Step 5.

gather components to assemble lower base. Use the Exploded View and the Labeling Diagram for part labels.

Reference Connection Method(s) 1 and 2 for more details.

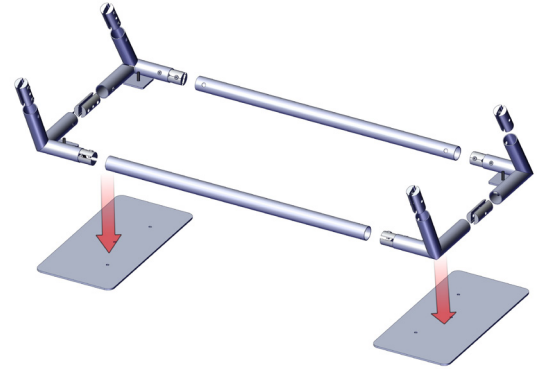
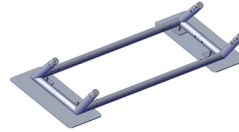

Step 6.

Gather the components to attach base to structure. Use the Exploded View and the Labeling Diagram for part labels.

Reference Connection Method(s) 1 and 2 for more details.

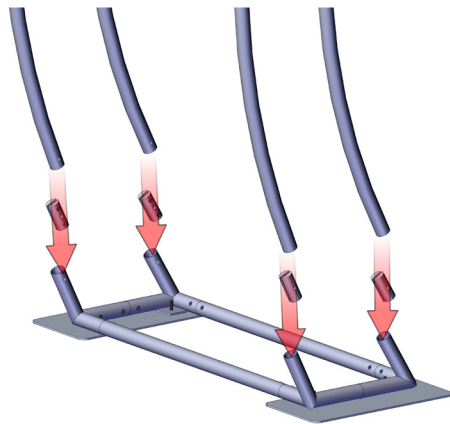
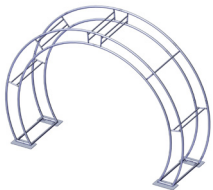

Step 7.

attach Arch-06 graphic. Slide over the frame closed with zipper

Setup is complete.

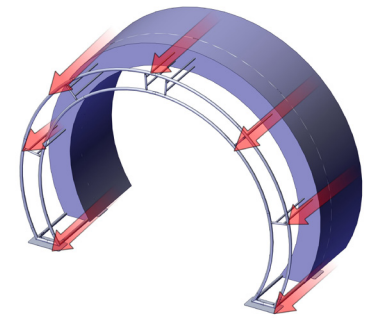
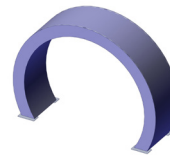

Connection Methods

Connection Method 1: ES50

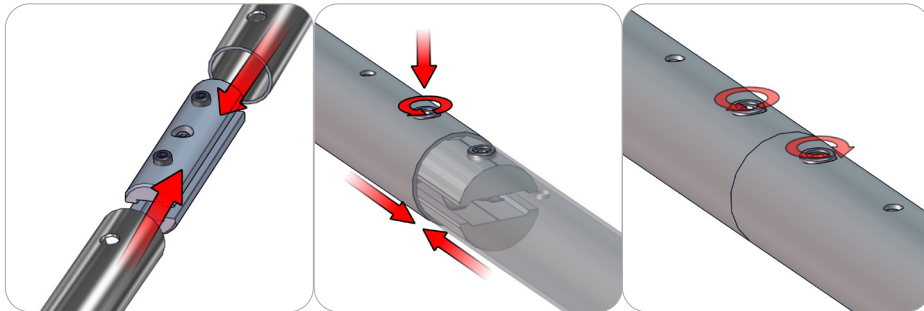

For spigot connections, compress the unlocked connector and slide into the tube lock access hole. Lock both screws carefully using your allen key tool. Be sure to lock securely, but do not over tighten. For snap button connections, locate the snap button on the connector or swage tube. Locate the hole on the corresponding tube.

Connection Method 2: TC-30D

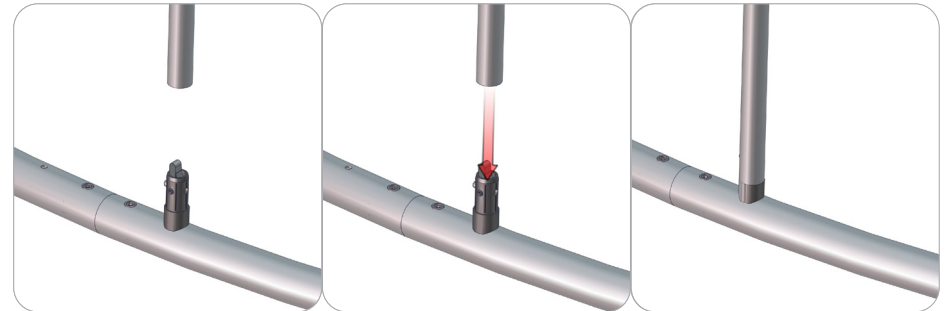

Press the snap button with your thumb and slide the tube and connector together so that the snap button snaps fully into the lock hole. To disassemble, press the snap button and pull apart.