

# Formulate 8' Square Backlit Tower

Mix and match the Formulate® line of towers to add architecture and drama to any event or interior space. Rectangular-shaped towers come in 12ft, 10ft and 8ft heights and 3ft square at the top and bottom. They combine the latest developments in fabric printed technology with aluminum tube frames to add dimension, decor and sculpture to any event, stage set, tradeshow booth or interior space. Formulate towers accommodate internal LED lighting to create a glowing effect.



**TOP VIEW**

We are continually improving and modifying our product range and reserve the right to vary the specifications without prior notice. All dimensions and weights quoted are approximate and we accept no responsibility for variance. E&OE. See Graphic Templates for graphic bleed specifications.

## features and benefits:

- State-of-the-art 30mm aluminum tube frame with snap button assembly
- Easy to store and ship
- Quick to set up
- Kit includes: one frame, one dye-sublimated zipper pillowcase graphic, internal lighting components, and one wheeled storage case
- Lifetime hardware warranty against manufacturer defects

## dimensions:

Hardware	Graphic
<p>Assembled unit: 36" w x 96" h x 36" d 915mm(w) x 2439mm(h) x 15mm(d)</p> <p>Approximate weight (includes graphic): 24 lbs / 11 kg</p>	<p>Refer to related graphic template for more information.</p> <p>Visit: <a href="https://www.tradeshowplus.com">https://www.tradeshowplus.com</a></p>
Shipping	<b>additional information:</b>
<p>Packing case(s): 1 OCL</p> <p>Shipping dimensions: OCL: 57" l x 19" h x 19" d 1448mm(l) x 483mm(h) x 483mm(d)</p> <p>Approximate shipping weight (with case): 44 lbs / 20 kg</p>	<p>Graphic material: Dye-sublimation zipper pillowcase fabric</p> <p>*This unit requires 6 light bulbs</p> <p>When included in a larger kit, a different packaging solution will be listed to accommodate all contents of the kit. Individual packaging no longer provided.</p>

# Included In Your Kit

Tools, Components, & Connectors



TC-30-3W x8



COL-01-T1 x6



COL-T2 x8



TC-30-T x4



COL-T5 x2



COL-01-T3 x4



TC-30-X x1



LED-CORN-24W x6



WC-30T x3



LED-LT-FXT-3WAY x2



COL-01-T4 x1



LED-LT-PWR-CORD x2



WIRE CONNECTION CLIP x3

Graphics



COL-03-BL-G x1

# Exploded View

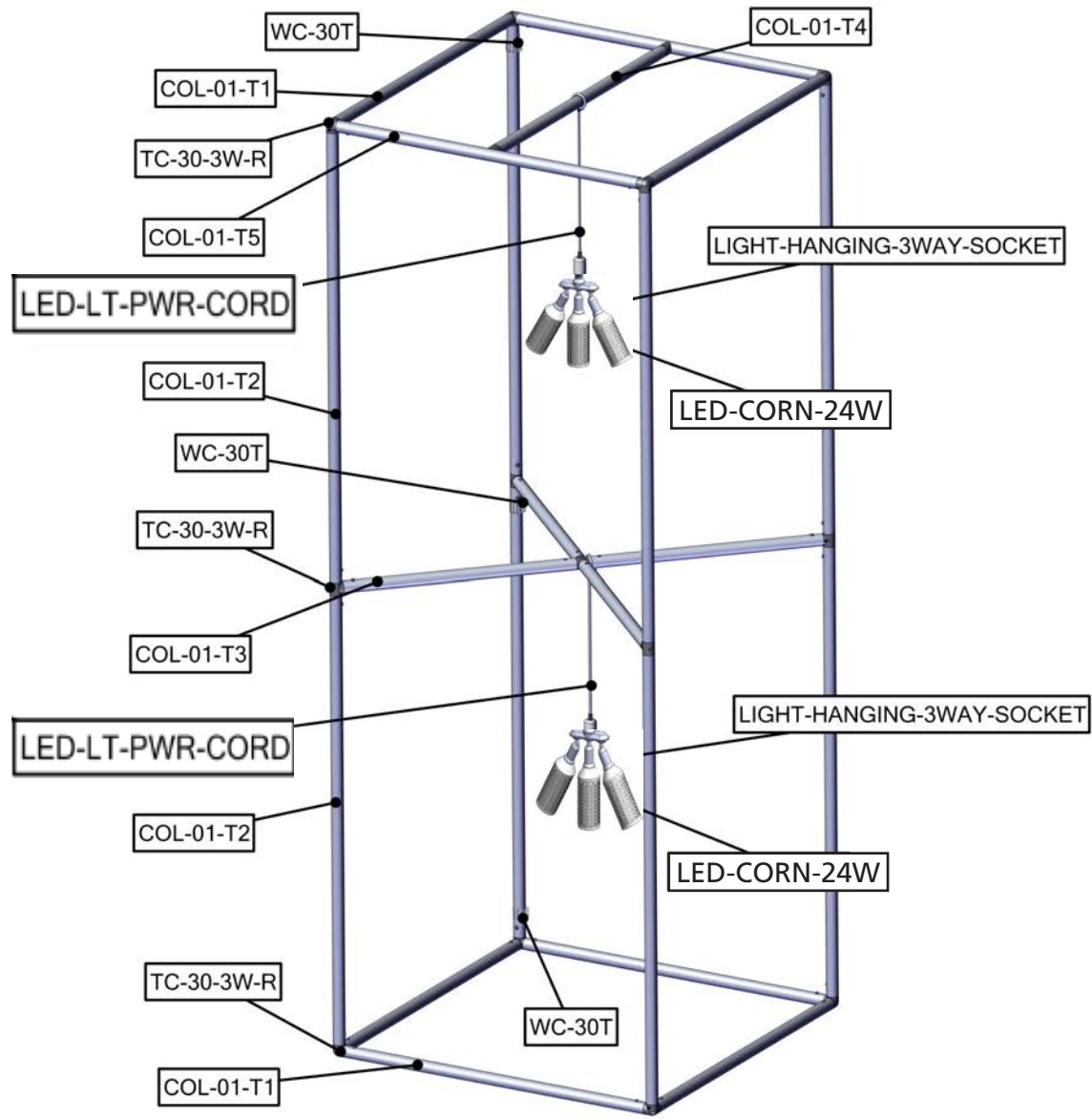

# Labeling Diagram

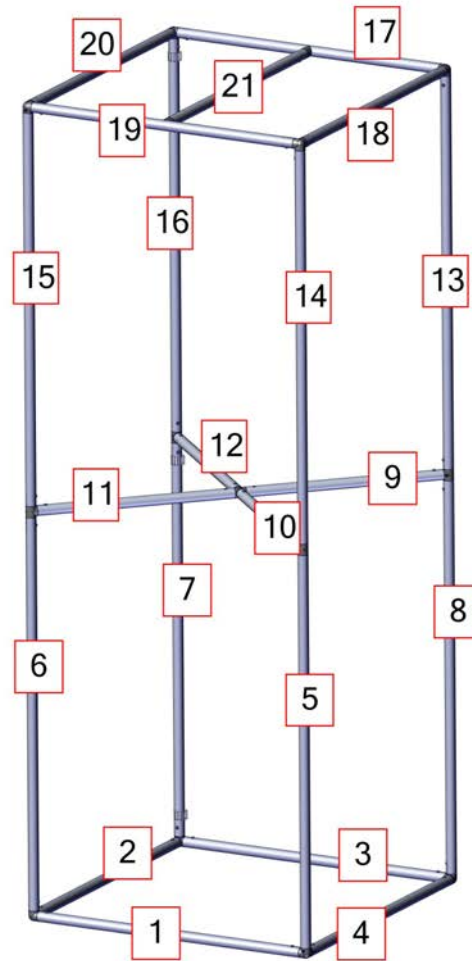

# Lighting Diagram

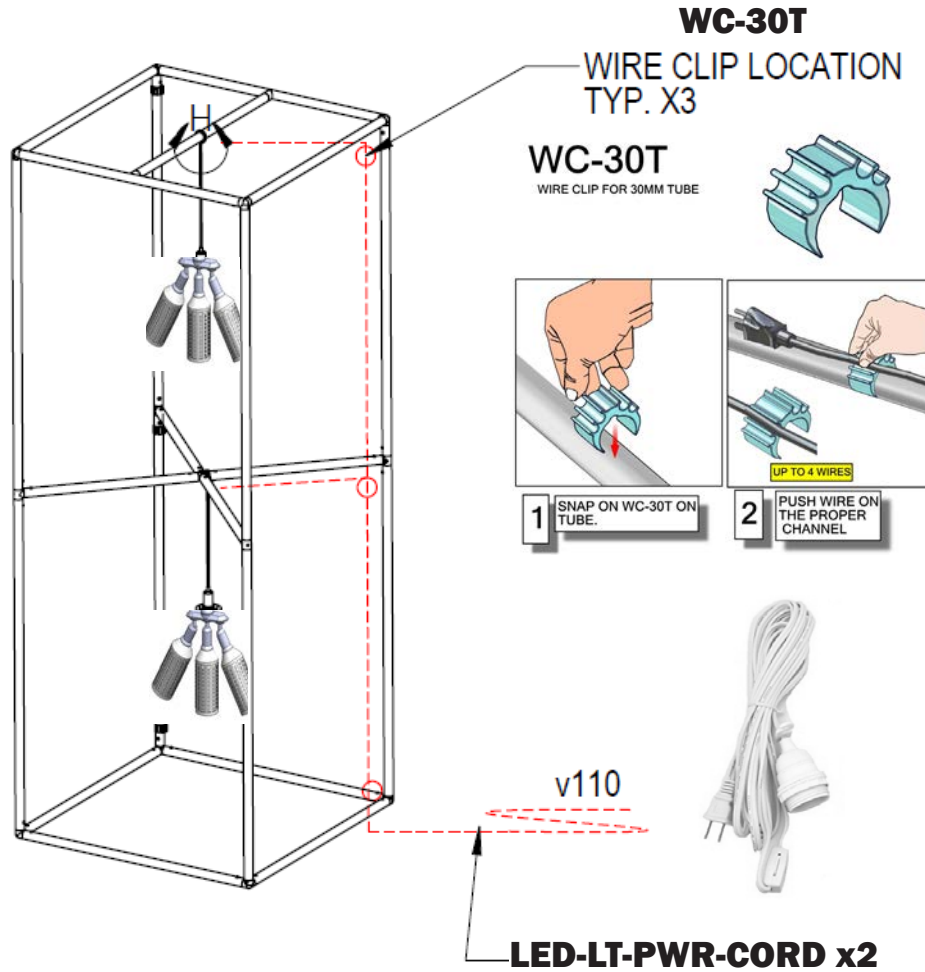
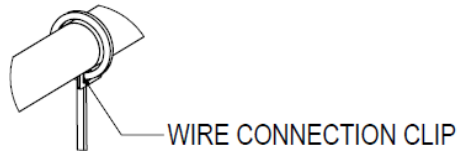

# Kit Assembly

## Step by Step

### Step 1.

Gather the components to build Section 1 of the tower frame. Use the Exploded View and the Labeling Diagram for part labels.

Reference Connection Methods 1 for more details.

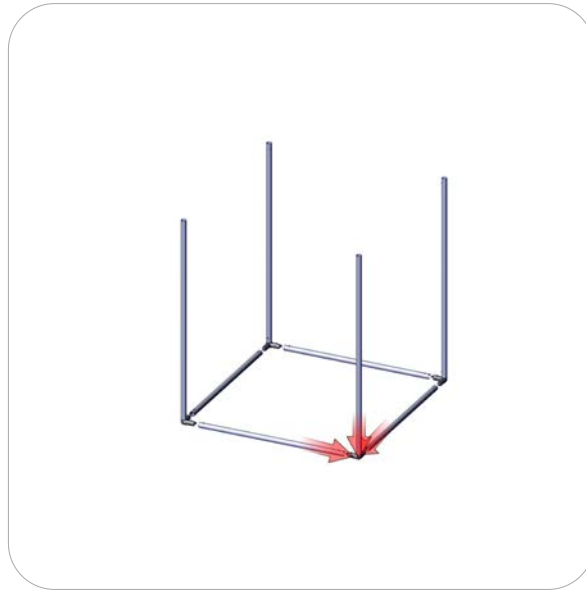

### Step 2.

Gather the components to build Section 2 of the tower frame. Use the Exploded View and the Labeling Diagram for part labels.

Reference Connection Method 2 for more details.

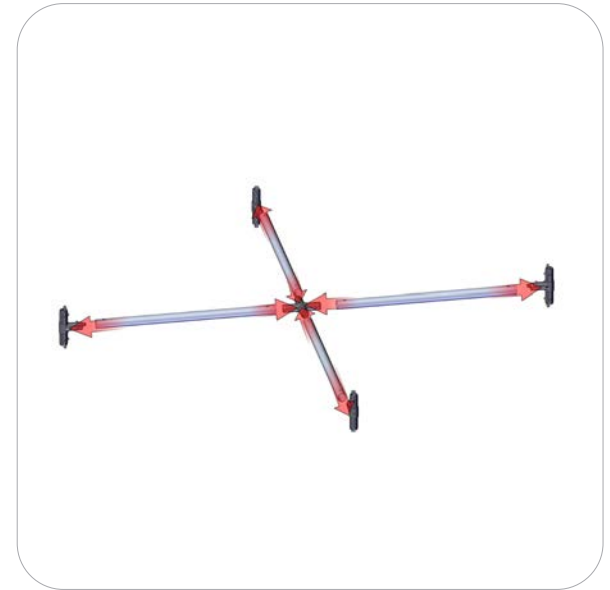

### Step 3.

Gather the components to build Section 3 of the tower frame. Use the Exploded View and the Labeling Diagram for part labels.

Reference Connection Methods 1 & 4 for more details.



### Step 4.

Lay the three sections flat on floor. Combine them to complete the tower frame assembly. Use the Exploded View and the Labeling Diagram for part labels.

Reference Connection Method 3 for more details.

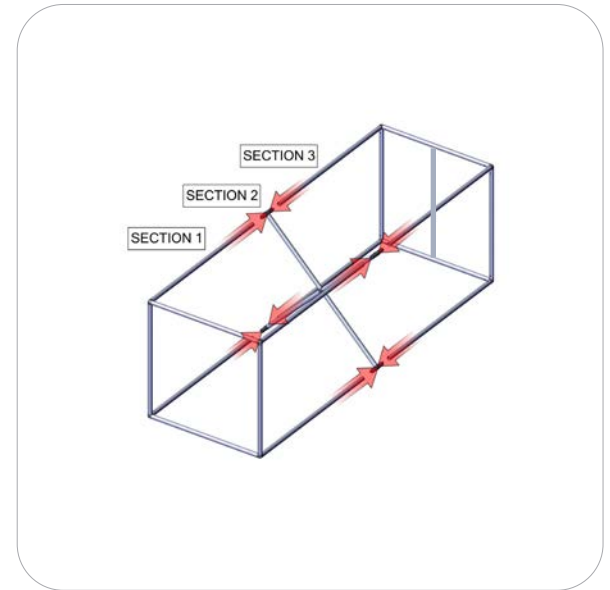
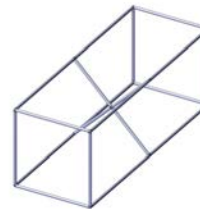

# Kit Assembly

## Step by Step

### Step 5.

Gather the components to connect lighting to the frame.

Connect the lighting components to the frame. Use the Exploded View and Lighting Diagram for part labels. These components simply hang from tube T4 at the top of the frame and the power cable runs down and out of the bottom opening.

**-See Light Diagram**

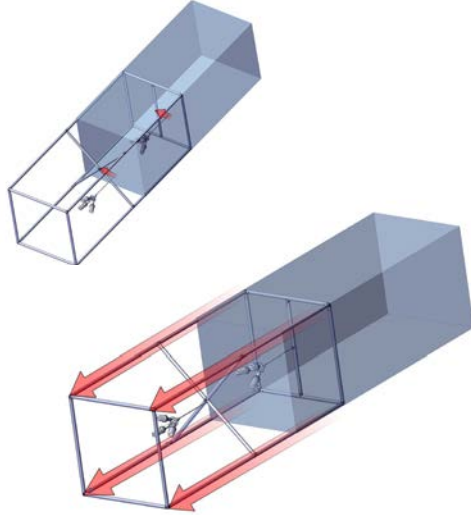

### Step 6.

Close the zippers and carefully stand the tower upright.

**Setup Complete**

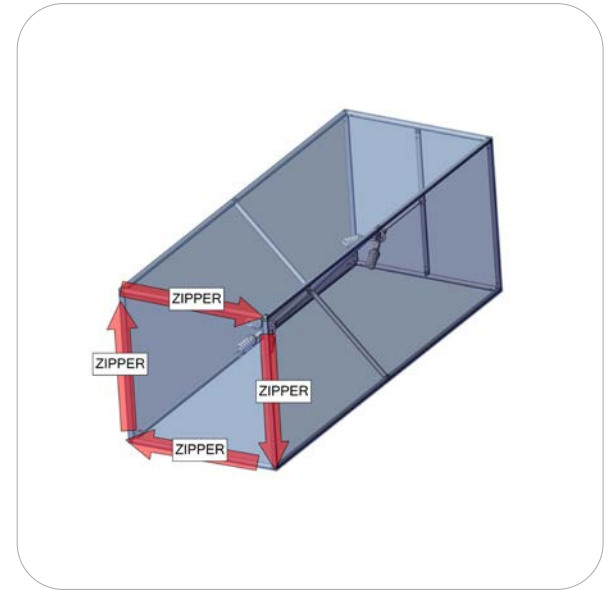

# Connection Methods

## Connection Method 1: COL-01-T1/ COL-01-T2/ TC-30-3W

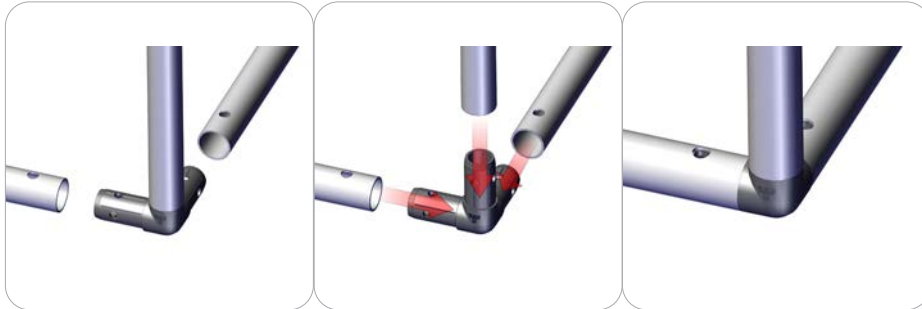

First, Connect bottom tubes (COL-T1) and side tubes (COL-T2) to TC-30-3W. Repeat previous step until all four sides of bottom are assembled. Use this method for the TOP & BOTTOM.

## Connection Method 2: TC-30-X

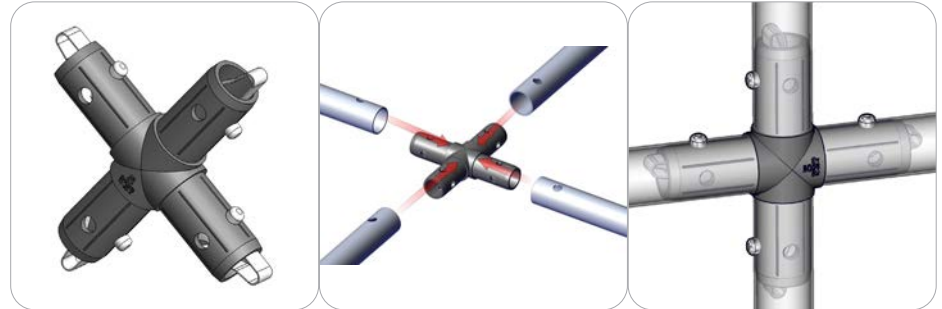

First, connect spreader tubes (COL-T3) to TC-30-X. Second, once the X frame is assembled, connect side tubes (COL-T6).

## Connection Method 3: COL-01-T2/ TC-30-T/ COL-01-T3

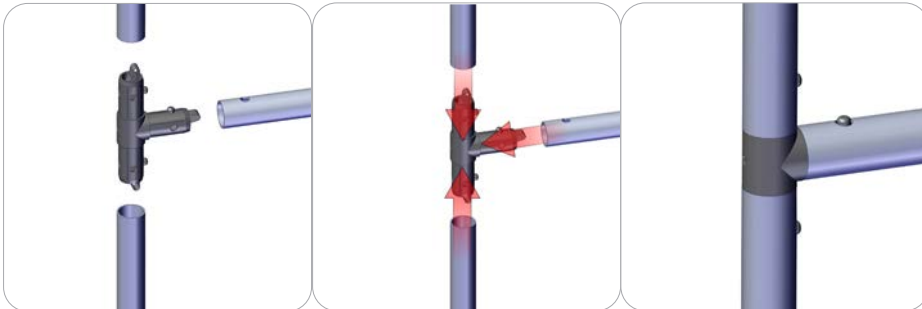

Slide the COL-01-T3 into the TC-30-T until it snaps in place. Repeat this for all 4 middle sections. Follow same process with connecting COL-01-T2 to TC-30-T.

## Connection Method 4: COL-01-T4/ COL-01-T5

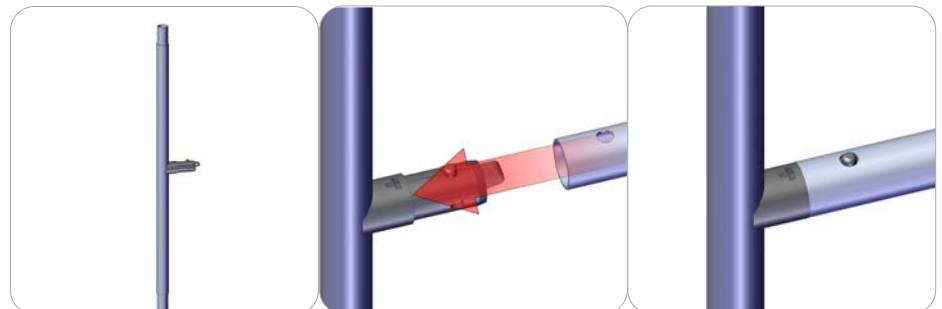

Snap button connections are simple and easy to use. First, locate the snap button on the connector or swage tube. Second, locate the hole on the corresponding tube. Press the snap button with your thumb and slide the tube and connector together so that the snap button snaps fully into the hole. To disassemble, press the snap button and carefully pull them apart.