

Formulate 20ft Funnel Tower

Formulate Funnels transform any environment through form, fabric and lighting. Funnels feature a heavy-duty, wooden base and silver powder coated truss interior to create a dynamic, towering structure that commands attention. Fabric graphics feature a zipper at the top and a silicone edge at the bottom for easy assembly. Accent LED light kits are not included, but can be purchased a la carte to add a glow within the funnel structures.



features and benefits:

- State-of-the-art 30mm curved aluminum tube frame with expanding spigots
- Easy to store and ship
- Quick to set up
- Kit includes: one frame, one dye-sublimated zipper pillowcase graphic, and two wheeled molded OCH2 storage cases (base packs separately).
- Lifetime hardware warranty against manufacturer defects

dimensions:

Hardware

Graphic

Assembled unit:
98.5" w x 237" h x 98.5" d
2502mm(w) x 6020mm(h) x 2502mm(d)

Refer to related graphic template for more information.

Approximate weight (includes graphic):
172 lb / 78 kg

Visit:
www.tradeshowplus.com

Shipping

additional information:

Must be shipped freight.

Graphic material:
Dye-sublimation zipper pillowcase fabric

Shipping dimensions:

42" diameter Base
1067mm diameter Base

2 OCH2 cases (each case):
52" l x 29" h x 15" d
1321mm(l) x 737mm(h) x 381mm(d)

Approximate shipping weight (with cases):
232 lb / 105 kg

When included in a larger kit, a different packaging solution will be listed to accommodate all contents of the kit. Individual packaging no longer provided.

We are continually improving and modifying our product range and reserve the right to vary the specifications without prior notice. All dimensions and weights quoted are approximate and we accept no responsibility for variance. E&OE. See Graphic Templates for graphic bleed specifications.

Included In Your Kit

Tools, Components, Connectors, Extrusions & Tubes



ALLEN KEY SET x1



ES30 x12



FUN-PLATE-ST x2



FUN-BASE x1



FUN-PH-45 x3



FUN-HUB-TRI x1



FUN-1200MM-TRI-30 x4



FUN-T1 x3



FUN-T2 x3



FUN-T2-SP x3

Graphics



FUN-01-G x1

Exploded View

FUN-01

Section 1

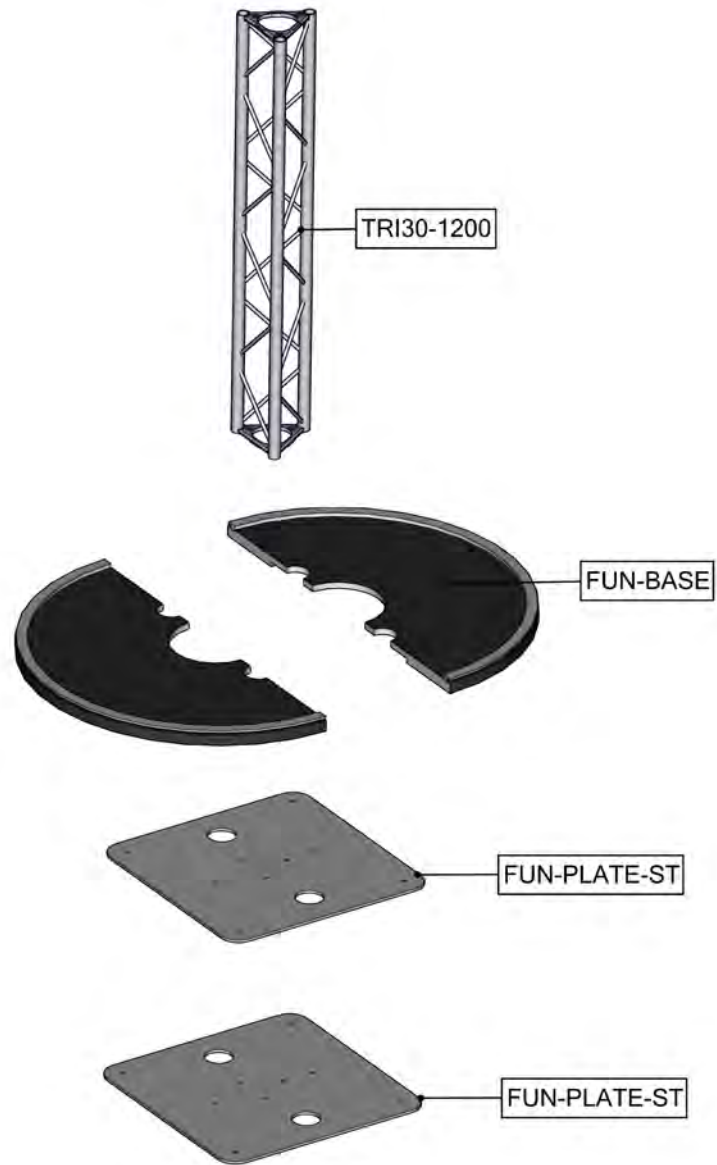

Exploded View

FUN-01

Section 2

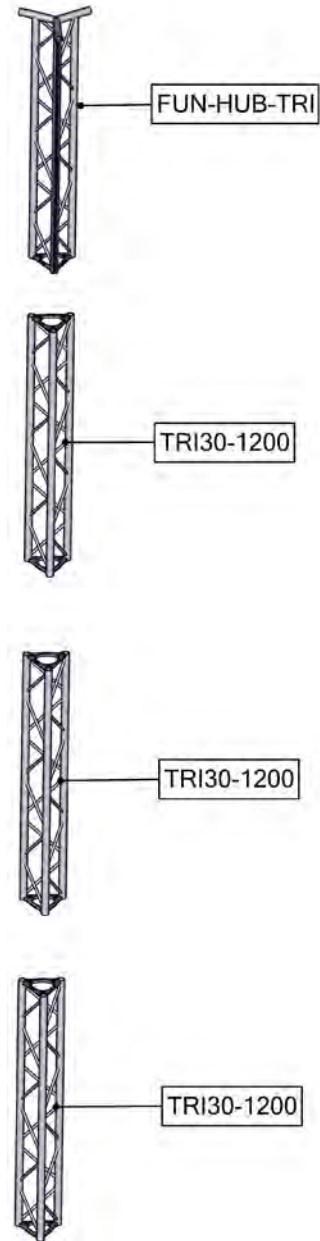

Exploded View

FUN-01

Section 3

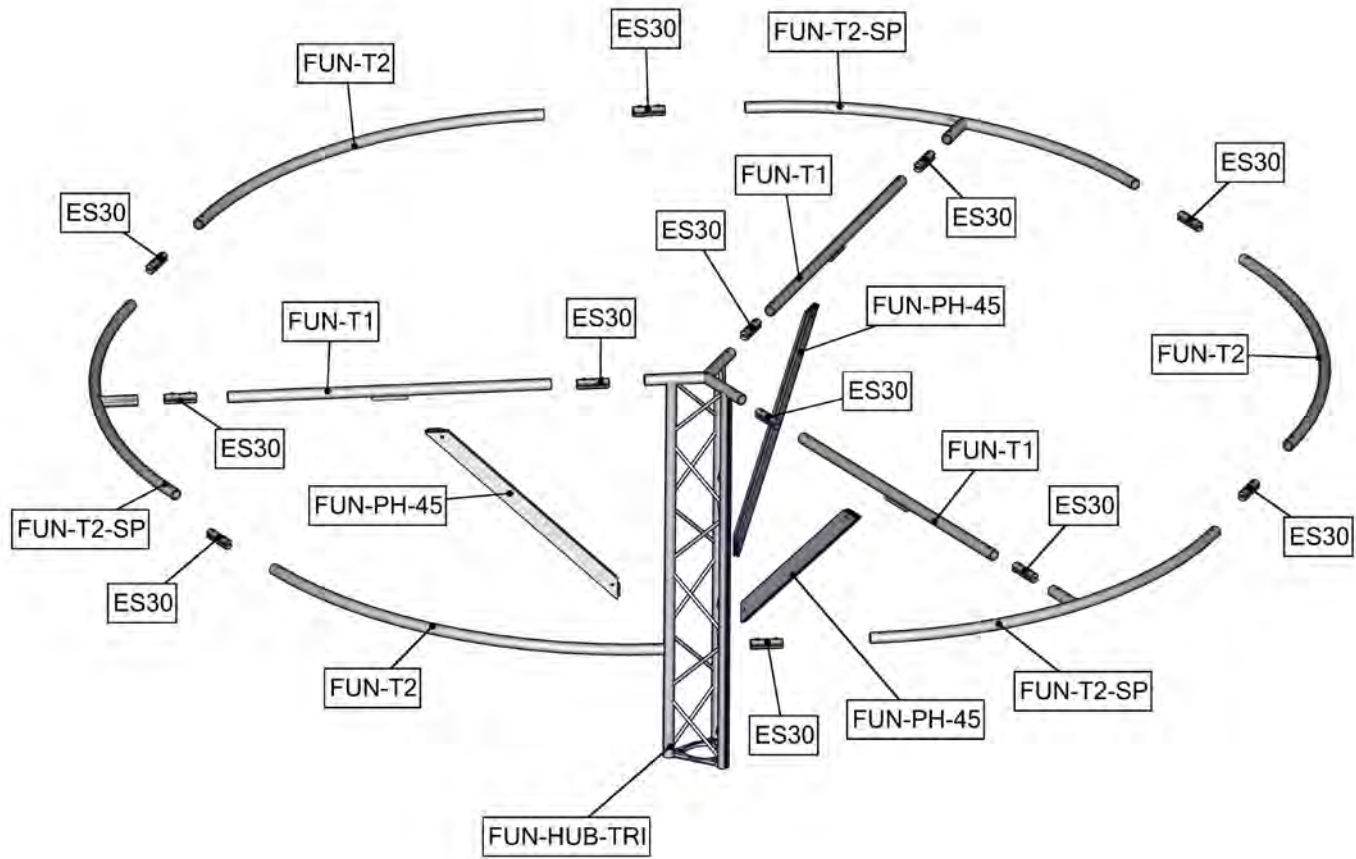

Labeling Diagram

FUN-01

Section 3

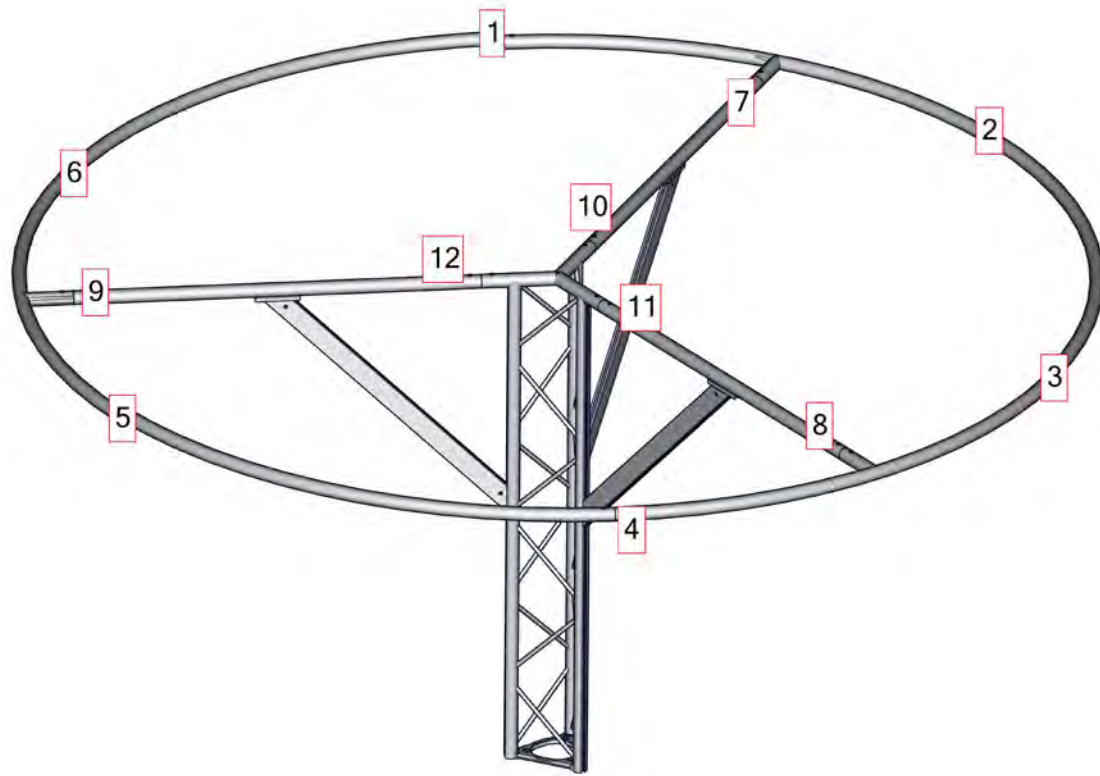

Connection Methods

Connection Method 1: FUN-BASE / FUN-PLATE-ST



Take the two halves of the wooden round base with the two metal base plates and align them together. Use the provided hardware to fasten them together. There are four corners that you will need to fasten, each corner gets 1 bolt, 1 washer and 1 wing nut. Fasten them tight.

Connection Method 2: FUN-BASE / TRI-30



Use the provided hardware to fasten the TRI-30 on to the metal base plates. There are three holes at the end of the TRI-30, each hole gets 1 bolt and 1 washer. Fasten them tight.

Connection Method 3: TRI-30



Use the provided hardware to fasten the Trilok TRI-30 to TRI-30. There are three holes to each Trilok section, each hole gets 1 bolt and 1 wing nut. Fasten them tight.

Connection Method 4: ES30

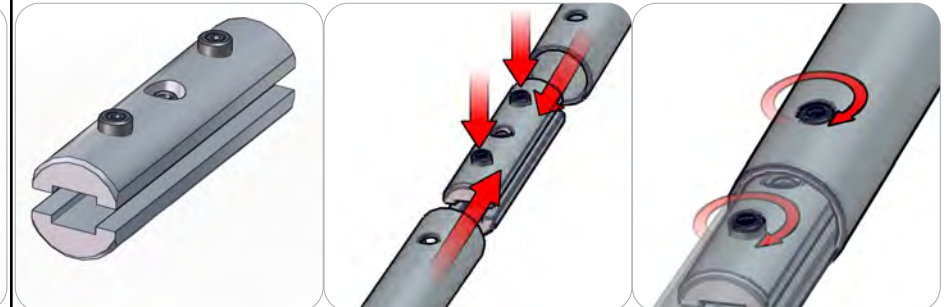

Turning counter clock-wise, loosen the screws found inside of the spigot buttons. Do not remove them. Compress the spigot and insert into the tubes. Once the spigot is in the tubes, the spigot will decompress and the button will protrude through the tubes. Turning clock-wise, lock the spigot buttons in place. Do not over tighten.

Connection Methods

Connection Method 5: FUN-BASE / FUN-PLATE-ST

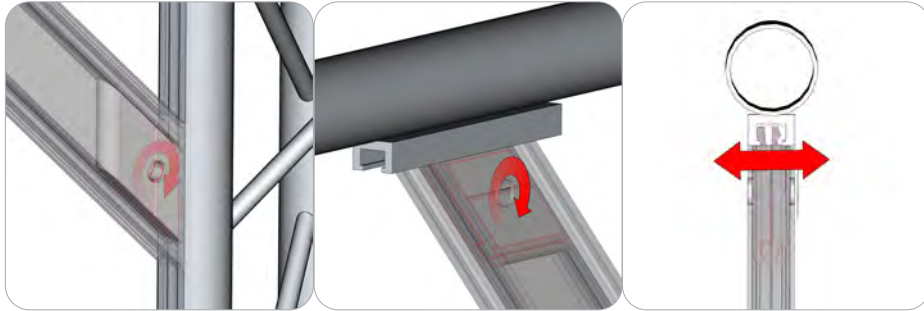

Turning counter clock-wise, use the provided allen key tool to disengage the clamp. Place the clamp teeth into the channel and turn clock-wise to engage into place. Do not over tighten.

Connection Method 6: FUN-01-G / FUN-BASE

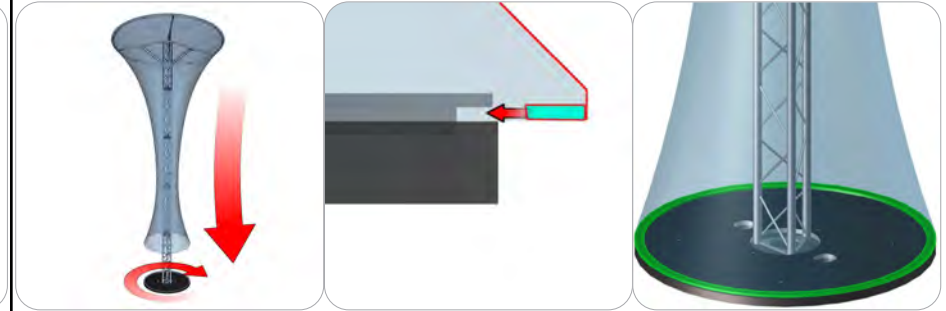

Once the pillowcase is zippered at the top ring and the tower is upright, pull the bottom end of the fabric into the round wooden base fabric channel.

Kit Assembly

Step by Step

Step 1.

Gather the components needed to assemble the base and the first Trilok truss upright. Use exploded view section 1 for layout. Leave the assembly laid out on the floor. Do not stand until Step 4. Reference Connection Methods 1 and 2 for more details.

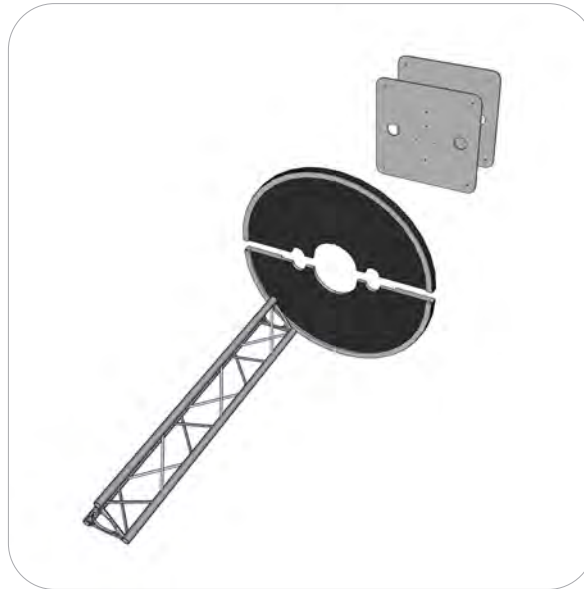

Step 2.

Gather the components needed to assemble the rest of the Trilok truss uprights. Use exploded view section 2 for layout. Leave the assembly laid out on the floor. Do not stand until Step 4. Reference Connection Method 3 for more details.



Step 3.

Gather the components needed to assemble the top of the funnel. Use section 3 sheets for layouts and tube labels. Leave the assembly laid out on the floor. Do not stand until Step 4. Reference Connection Methods 3, 4 and 5 for more details.

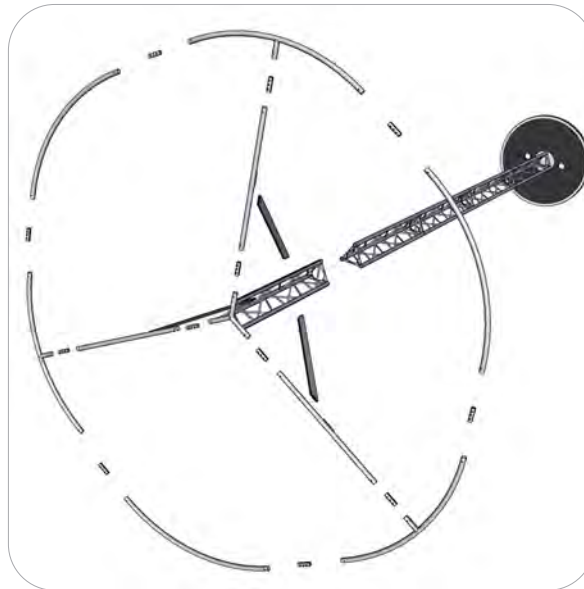

Step 4.

Apply the fabric pillowcase while the Funnel frame is still laid out on the floor. Zipper the pillowcase at the top. Carefully stand the funnel with pillowcase. Reference Connection Method 6 for more details.



Kit Assembly

Step by Step

Step 5.

With the funnel standing upright, pull the pillowcase down towards the round wooden base.

Reference Connection Method 6 for more details.



Step 6.

Setup is complete.

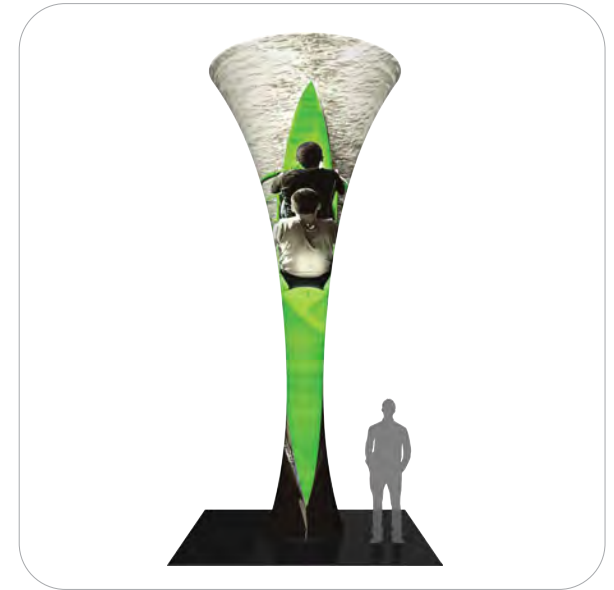

Check out these related products:

The Formulate line is a collection of stylish, ergonomically designed tabletop, 8ft, 10ft, 20ft exhibits, hanging structures, and display accessories. Formulate combines state-of-the-art zipper pillowcase dye-sublimated fabric coverings with a premium lightweight aluminum structure. Formulate is efficient, easy to assemble and disassemble, and offers remarkable style options and choices.



Formulate 20ft Column



Formulate 10ft Column



Formulate 8ft Column



Formulate 16ft Funnel



Formulate 12ft Funnel



Formulate 12ft Cylinder



Formulate 10ft Cylinder



Formulate 8ft Cylinder