

Formulate Master 20ft Horizontal 10ft Tall Display

Formulate is a collection of sophisticated, ergonomically designed exhibit booths. Formulate combines state-of-the-art zipper pillowcase dye-sublimated fabric coverings with advanced lightweight aluminum structures to provide unique design, functionality, and style. The excellence of the Formulate line of displays, hanging structures and products is simply unmatched. Stretch fabric graphics are hand-sewn, durable and dry-cleanable.

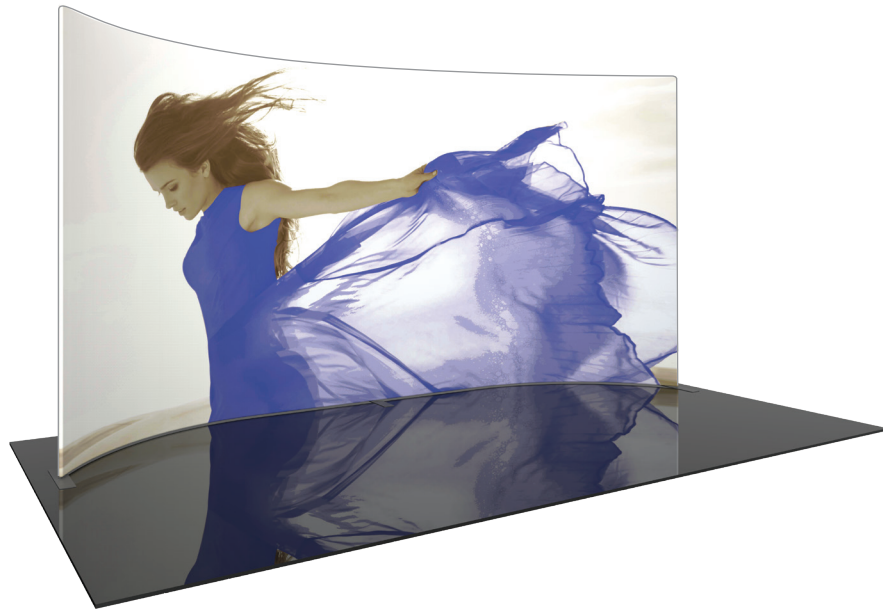

features and benefits:

- State-of-the-art 30mm aluminum tube frame with snap button assembly
- Easy to store and ship
- Quick to set up
- Frame converts down to an 8' height
- 8' height graphic sold separately
- Kit includes: one frame, one dye-sublimated zipper pillowcase graphic, and two wheeled molded storage case
- Lifetime hardware warranty against manufacturer defects

dimensions:

Hardware

Assembled unit:
226.60"w x 120.5"h x 54.91"d
5756mm(w) x 3061mm(h) x 1395mm(d)

Approximate weight:
59 lb / 27 kg

Graphic

Refer to related graphic template for more information.

One year warranty

Visit:
<https://tradeshowplus.com>

Shipping

Packing case(s):
2 OCE

Shipping dimensions:
OCE: Expandable case length (l) may vary
40" - 66"l x 18"h x 18"d
1016mm-1677mm(l) x 458mm(h) x 458mm(d)

Approximate total shipping weight:
113 lb / 52 kg

additional information:

Graphic material:
Dye-sublimation zipper pillowcase fabric

When included in a larger order, a different packaging solution will be provided to accommodate all contents of the order. Individual packaging may no longer be provided.

We are continually improving and modifying our product range and reserve the right to vary the specifications without prior notice. All dimensions and weights quoted are approximate and we accept no responsibility for variance. E&OE. See Graphic Templates for graphic bleed specifications.



This product may include the following materials for recycle:
aluminum, select wood, fabric, cardboard, paper, steel, and plastics.

Included In Your Kit

Components, Connectors & Graphics

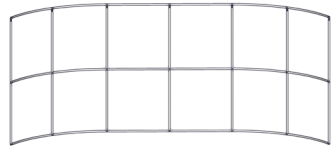

FMLT-WH20-F x1

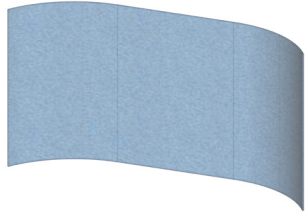

FMLT-WH2010-G x1



TUBE-679 x7



WH-20-T3 x2



WH-20-T1 x4

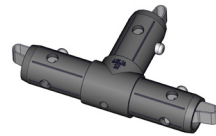

TC-30-T x2

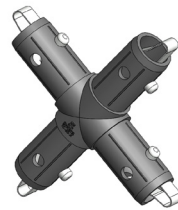

TC-30-X x5

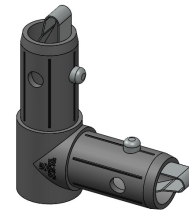

TC-30-90B x2

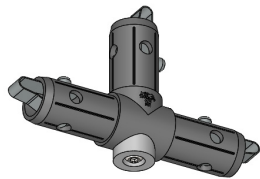

TC-30-T-CS x4

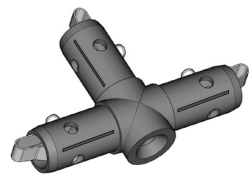

TC-30-TB x1

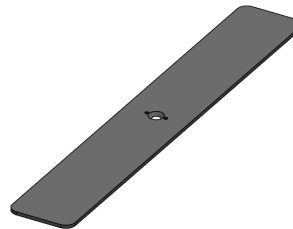

PLT-BP-LN114-S2-450 x3



LN114-SCRW x3



6MM-HEX-KEY x1

FMLT-10FT-EXT-FHC2010 x1

Exploded View

FMLT-WH2010

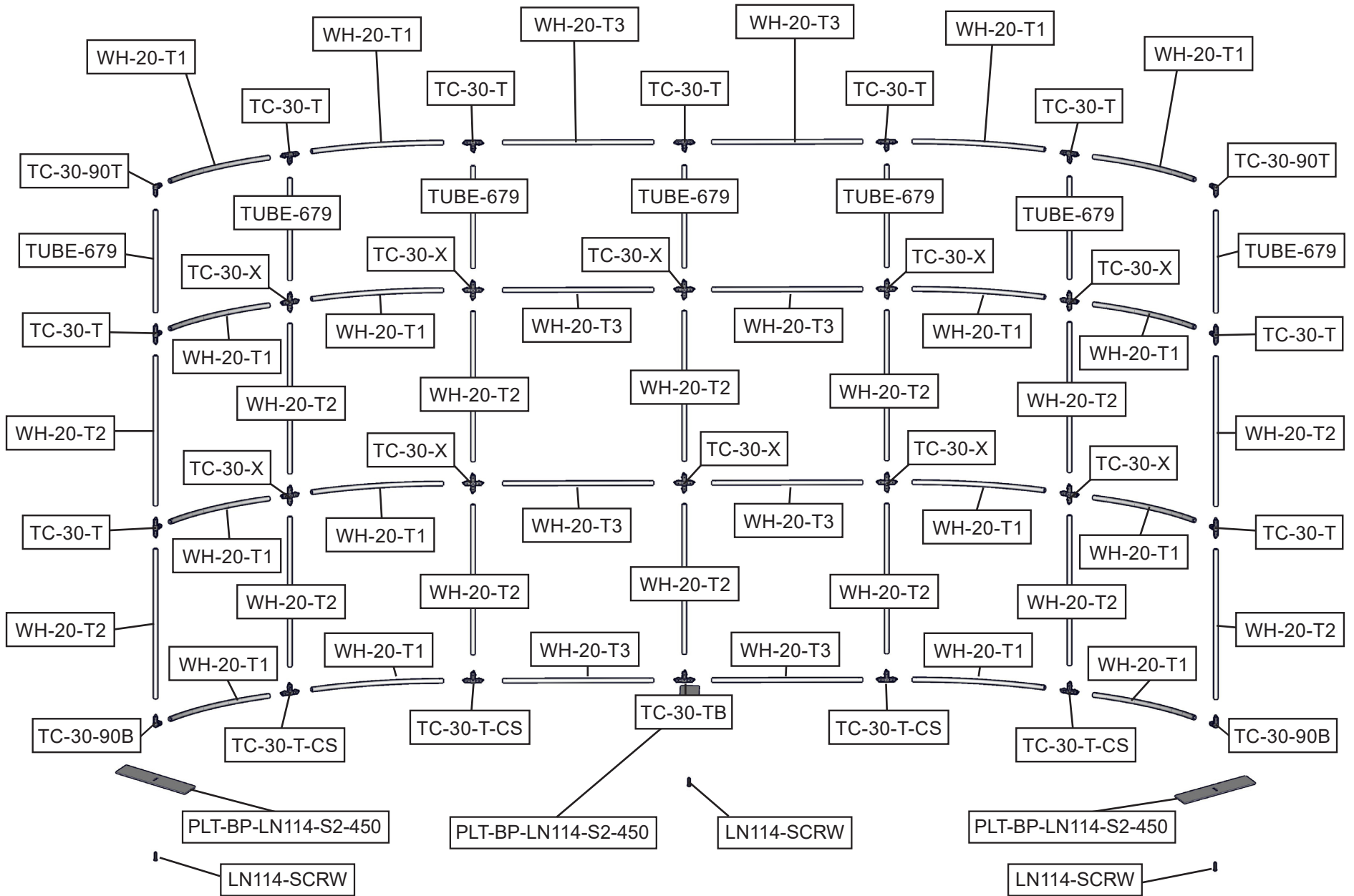

Exploded View for 8' Height Frame Option

FMLT-WH20-F

8' height graphic sold separately

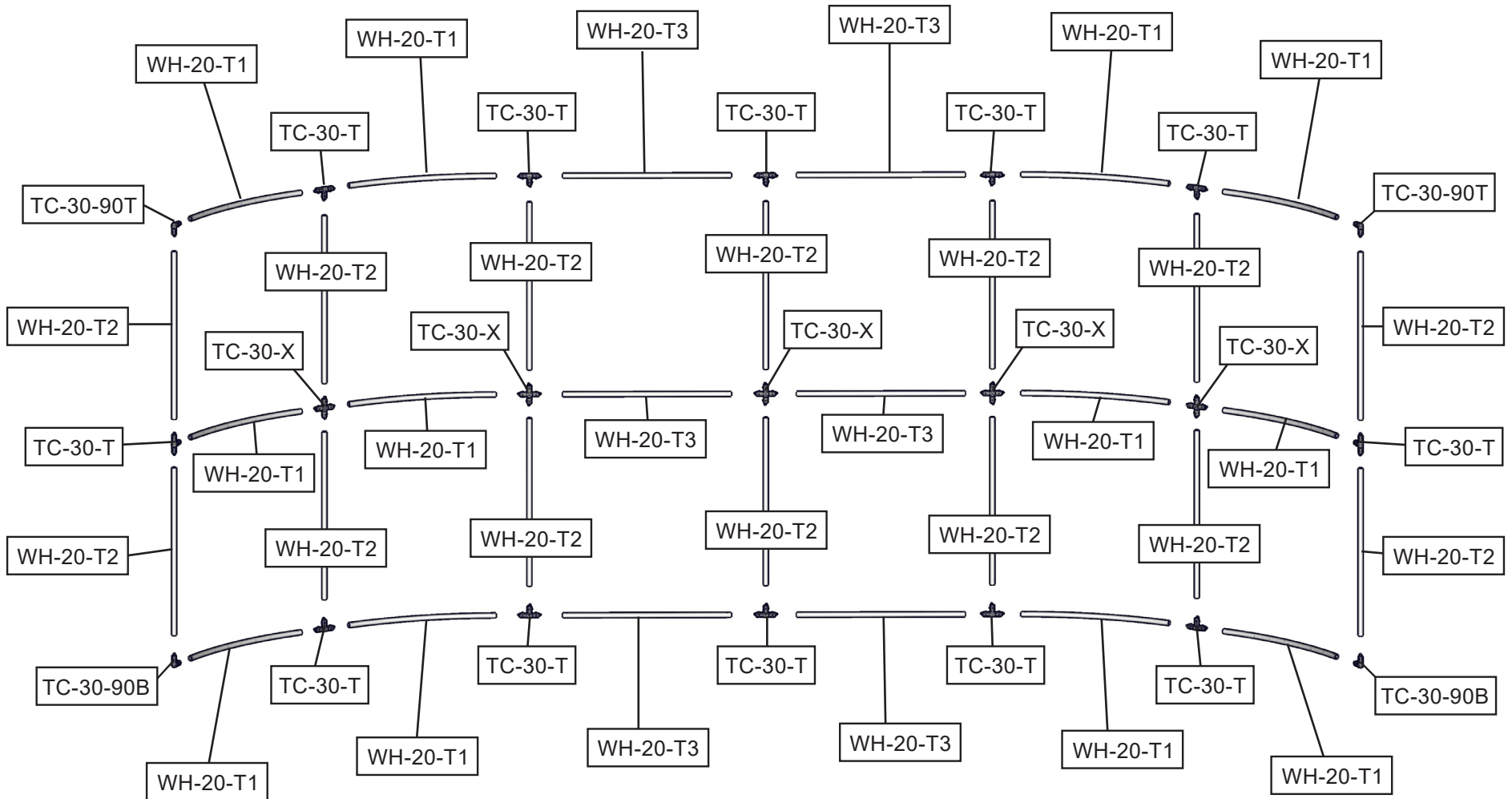

Connection Methods

Connection Method 1: TC-30-T

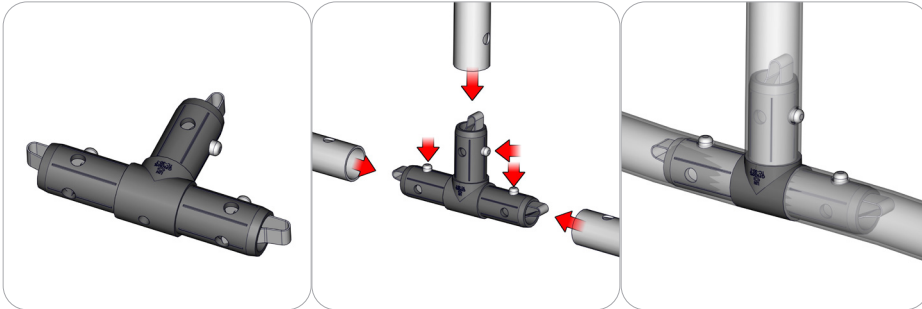

Take the plastic connector and make sure the snap buttons are in proper position for the frame tube holes. Simply press the snap button with your thumb and carefully slide the tube onto the connector. The snap button should pop through. Some twisting may be necessary to assure the snap button has popped all the way through the tube hole. Do not force the connection and be careful with the tube edges, they may be sharp.

Connection Method 2: TC-30-90T

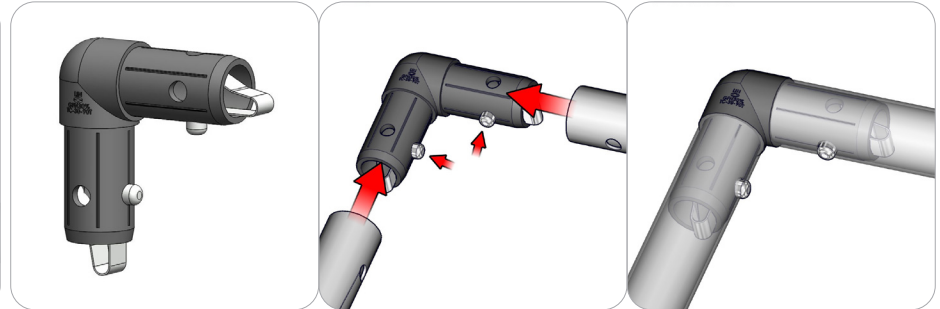

Take the plastic connector and make sure the snap buttons are in proper position for the frame tube holes. Simply press the snap button with your thumb and carefully slide the tube onto the connector. The snap button should pop through. Some twisting may be necessary to assure the snap button has popped all the way through the tube hole. Do not force the connection and be careful with the tube edges, they may be sharp.

Connection Method 3: TC-30-X

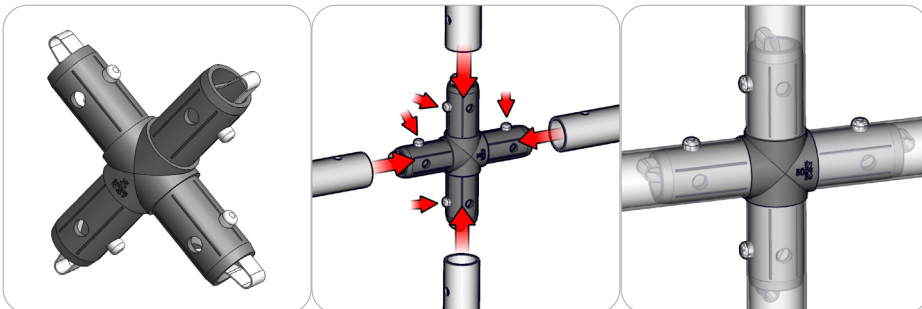

Take the plastic connector and make sure the snap buttons are in proper position for the frame tube holes. Simply press the snap button with your thumb and carefully slide the tube onto the connector. The snap button should pop through. Some twisting may be necessary to assure the snap button has popped all the way through the tube hole. Do not force the connection and be careful with the tube edges, they may be sharp.

Connection Method 4: TC-30-90B

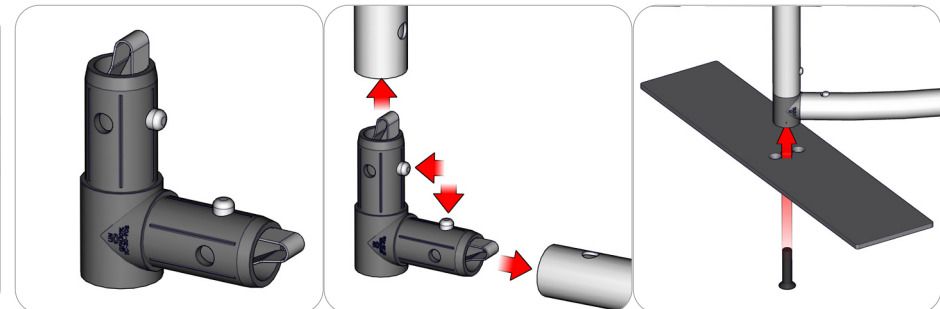

Take the plastic connector and make sure the snap buttons are in proper position for the frame tube holes. Simply press the snap button with your thumb and carefully slide the tube onto the connector. The snap button should pop through. Some twisting may be necessary to assure the snap button has popped all the way through the tube hole. Do not force the connection and be careful with the tube edges, they may be sharp.

With the plastic connector in secured place, use the provided hex key for attaching the base plate with the M10 screw. Once the base plate is in the desired position, tighten the set screw.

Kit Assembly

Step by Step

Step 1.

Gather the components to build the frame. Use the Exploded View for part labels.

Reference Connection Method(s) 1, 2, 3 and 4 for more details.

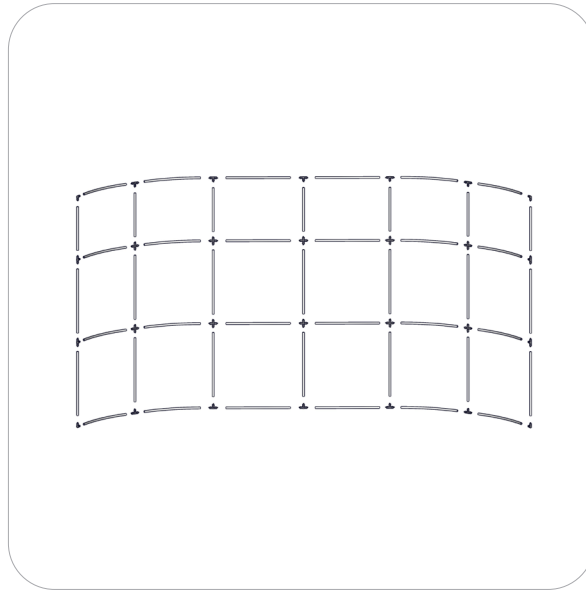
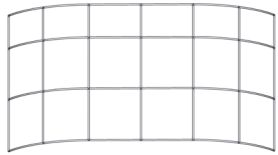

Step 2.

Pull the pillowcase graphic over the frame and zipper it closed at the bottom.

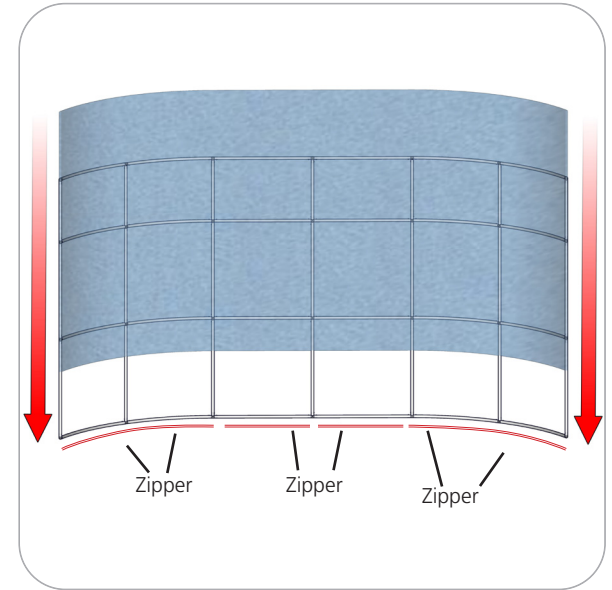
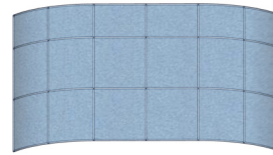

Step 3.

Locate the stabilizing bases. Attach each foot to the bottom ends of the frame. Use the allen key tool provided to fasten the bases in place.

Reference Connection Method(s) 4 for more details.

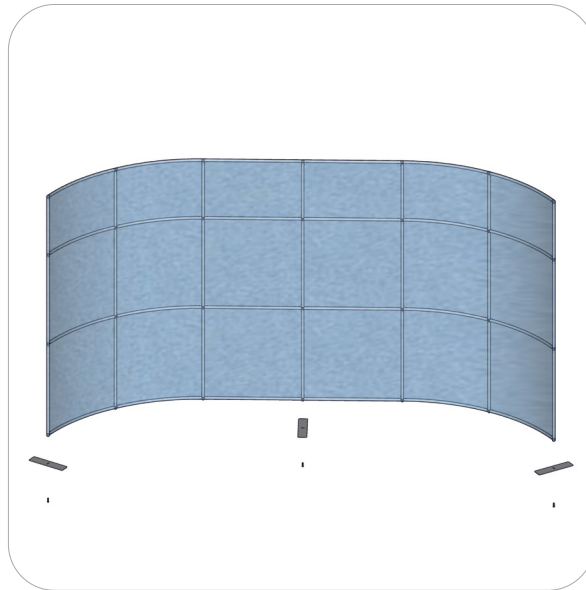
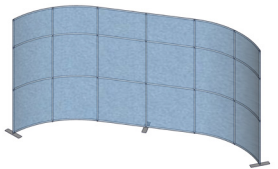

Step 4.

Setup is complete.

