

Embrace Monitor Mount

The Embrace Monitor Mount Bracket Kit integrates with any Embrace system 8ft high or taller to allow digital messaging. The monitor mount can be placed in any quad within the Embrace display and gives a floating monitor appearance. Maximum monitor size: 40" and/or 20 lbs.

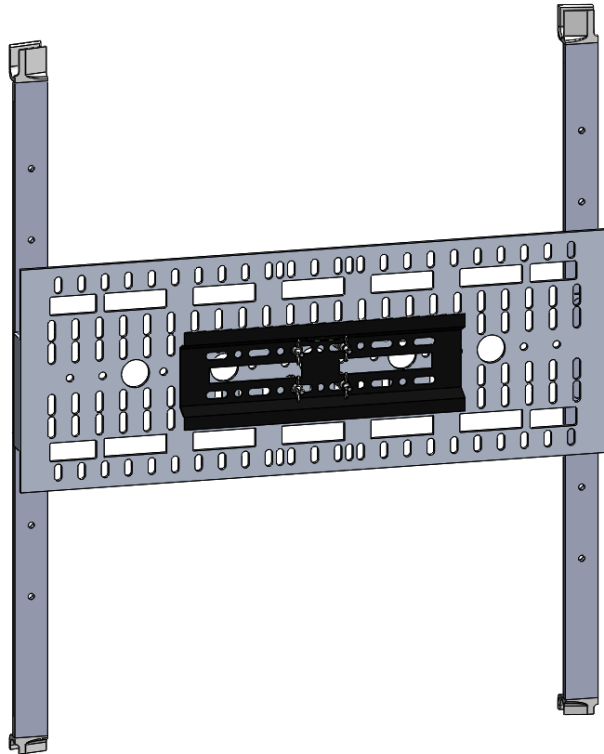

features and benefits:

- Monitor mount adds digital media presentation capabilities
- Add on to any Embrace backwall that is 3 or more quads high
- Can be installed on any quad
- Kit includes: 1 monitor mount (2 aluminum bars with plastic caps, 1 steel bracket) and carry bag
- Appears as a floating Monitor
- Monitor max weight: 20 lbs / 10 kgs
- Easy to assemble in the frame

dimensions:

Hardware

Assembled Unit:

Hardware dimensions:
24.48" w x 29.92" h x 2.76" d
622mm(w) x 760mm(h) x 71mm(d)

Approximate weight:
7 lbs / 4 kgs

Shipping

Packaging:
1 Box

Shipping Dimensions:
32" l x 11" h x 2" d
813mm(l) x 280mm(h) x 51mm(d)

Approximate total shipping weight:
8 lbs / 4 kgs

additional information:

Not recommended to attach to any frames under 3 quads high.

Monitor Mount can support max weight:
20 lbs / 10 kgs

Screws to attach monitor to Embrace bracket not included.

When included in a larger order, a different packaging solution will be provided to accommodate all contents of the kit. Individual packaging may no longer be provided.

We are continually improving and modifying our product range and reserve the right to vary the specifications without prior notice. All dimensions and weights quoted are approximate and we accept no responsibility for variance. E&OE. See Graphic Templates for graphic bleed specifications.



This product may include the following materials for recycle:
aluminum, select wood, fabric, cardboard, paper, steel, and plastics.

Included in Your Kit:

EMB-2-MM

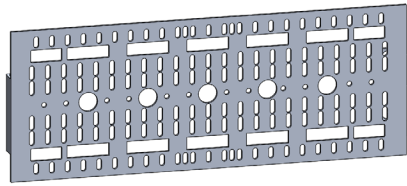

EMB-2-MM-BRKT

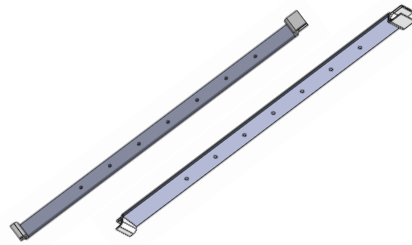

EMB-2-ACC-BRKT-2

(x1)

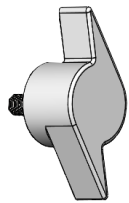

EMB-2-MM-SCRW

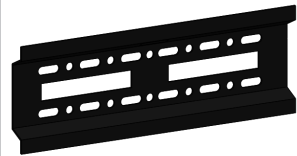

MM-SM-T



94639A573 SPACER

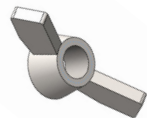

1/4-20-FLANGE-WING-NUT

(x4)

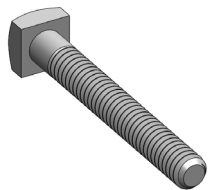

BOLT-2

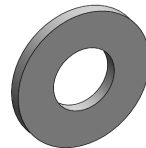

1/4-FENDER-WASHER

(x8)

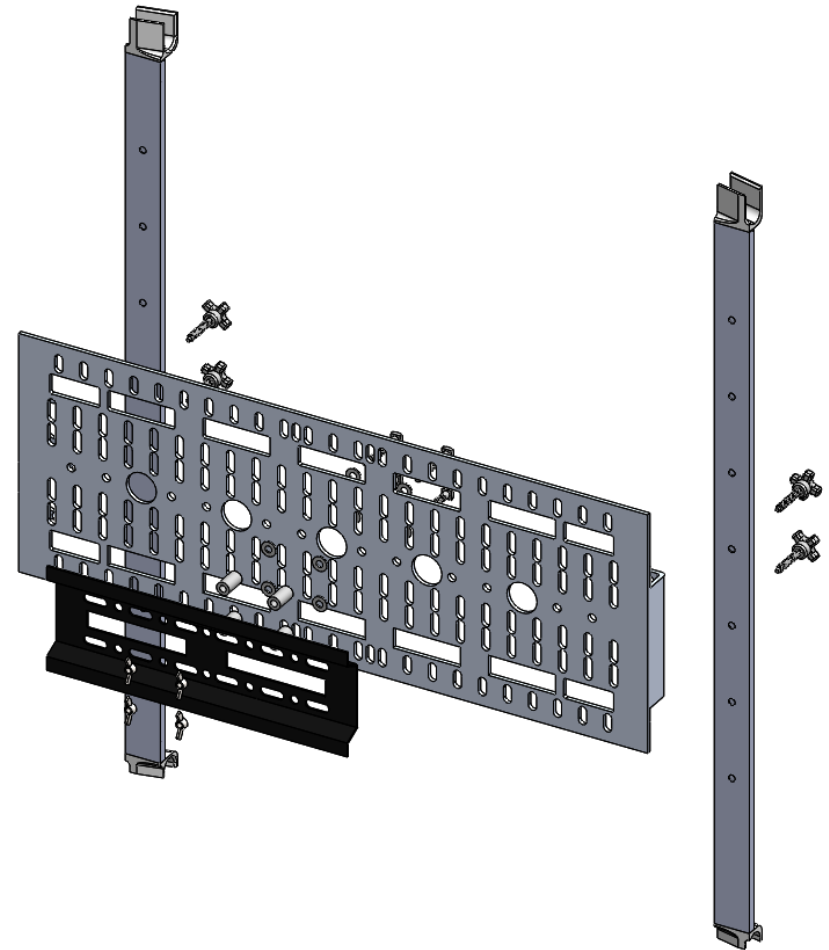

Monitor Mount Assembly Step 1

For this step you will need:

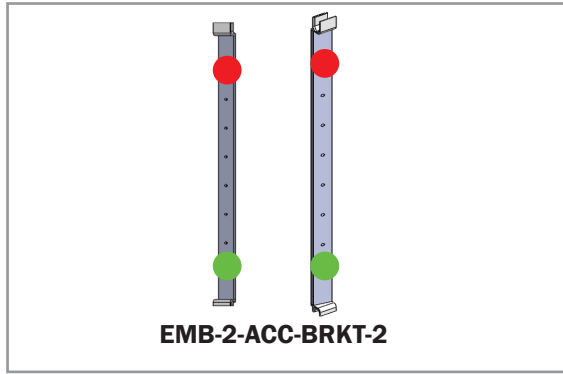

1. Locate the stickers on the Embrace monitor mount accessory brackets and adjust them so that they are rotated to the correct orientation.

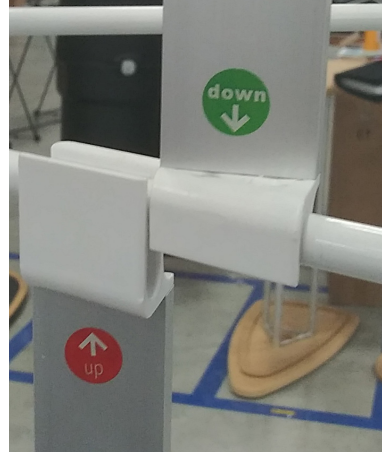

Need red to be facing upward

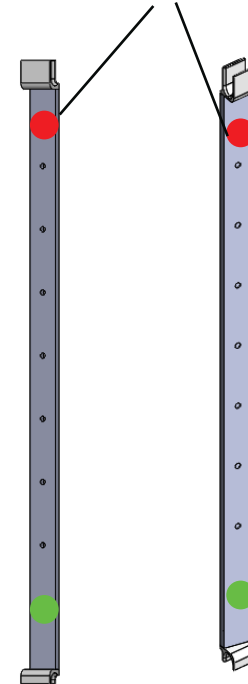

2. Using the stickers as a guide, align the accessory brackets and monitor bracket to their proper location before assembling.

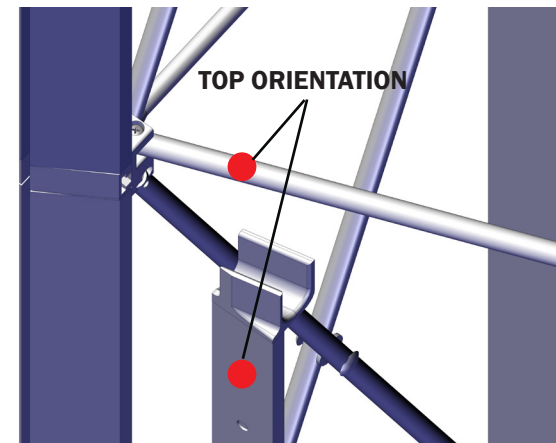
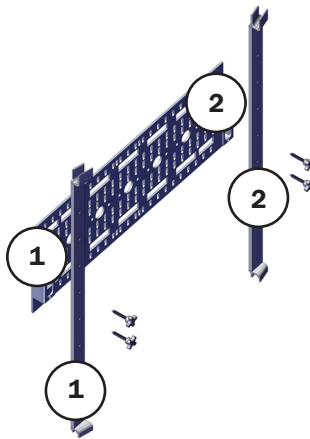

Monitor Mount Assembly Step 2

For this step you will need:

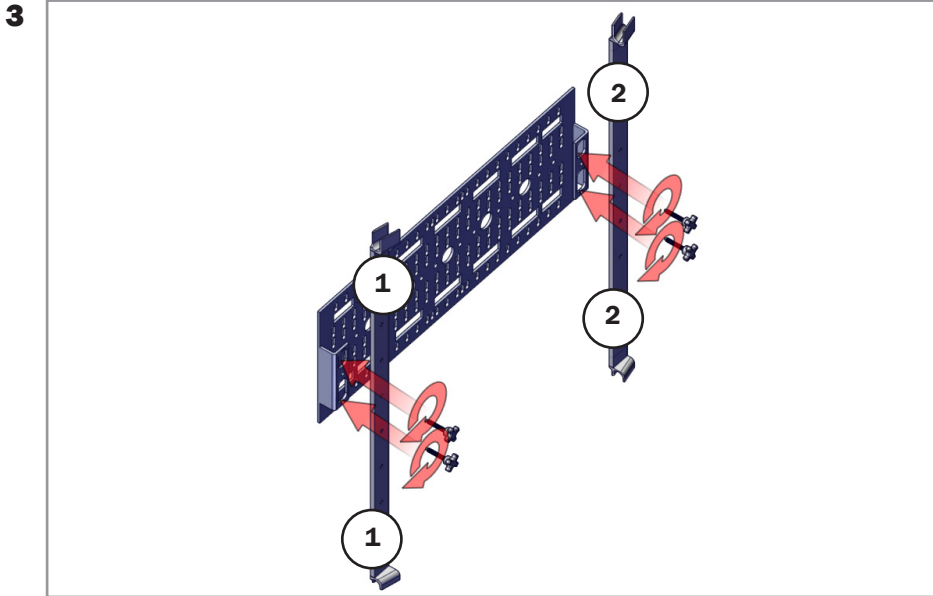
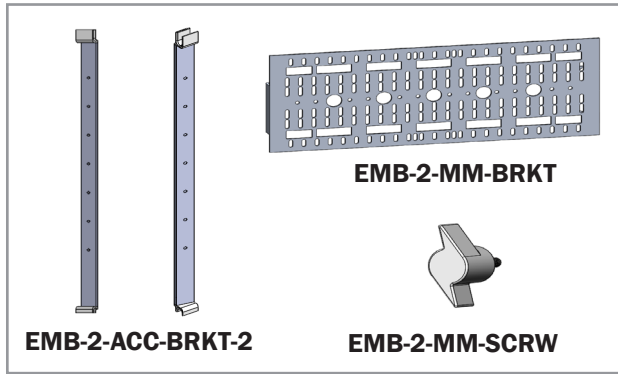

Assemble the Embrace monitor mount by attaching the monitor bracket to the accessory brackets using the included screws. Use the color stickers and number labels to help you assemble and know proper orientation of parts.

REAR VIEW

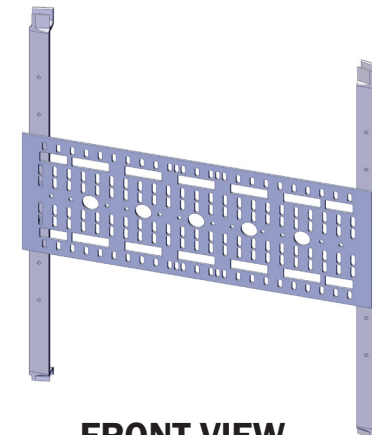
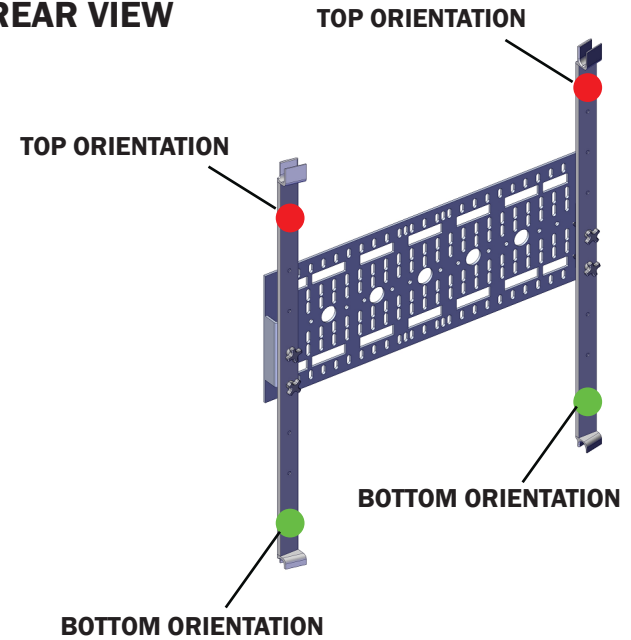

FRONT VIEW
COMPLETE SETUP

Monitor Mount Assembly Step 3

For this step you will need:

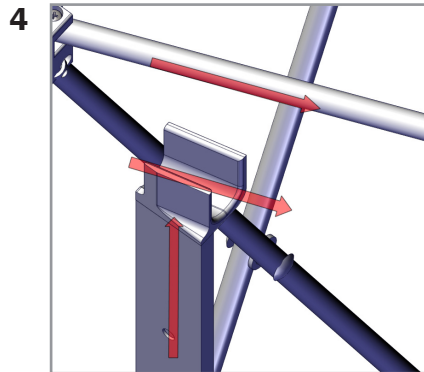
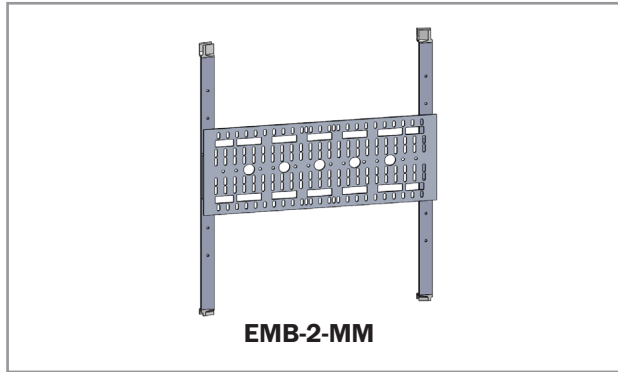

Assemble the monitor mount to the Embrace frame by first tilting it up and pushing the top of the accessory brackets to the upper Embrace scissors.

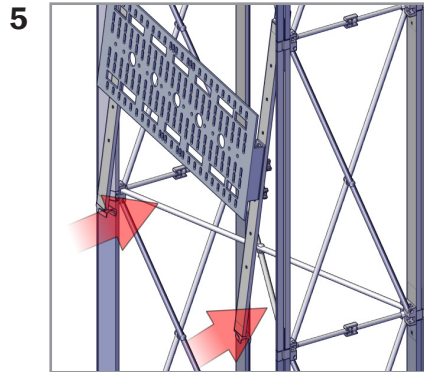

Finish the assembly by attaching the bottom of the accessory brackets to the Embrace scissors. You may need to push the brackets up to fit them in place.

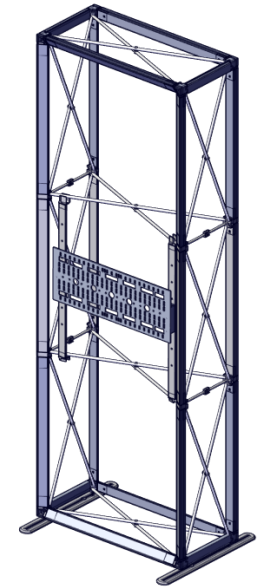
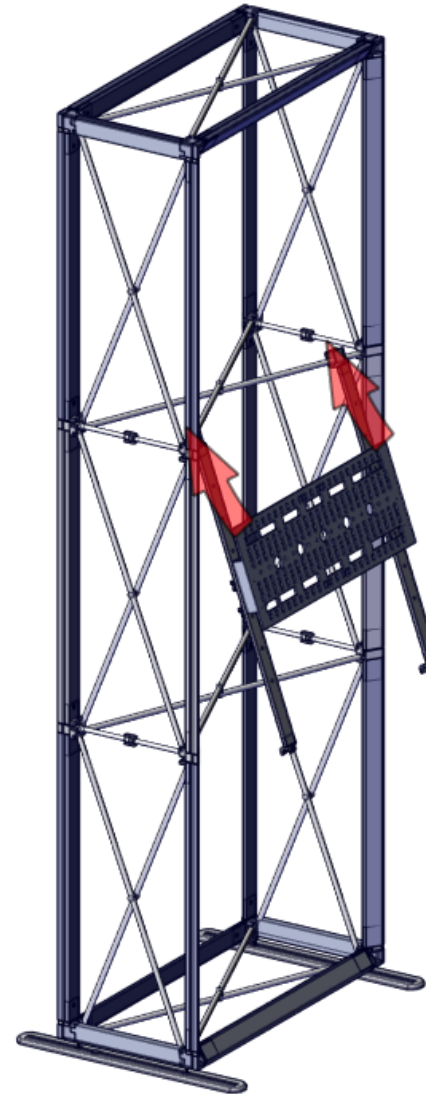

COMPLETE SETUP

Monitor Mount Assembly Step 4

For this step you will need:

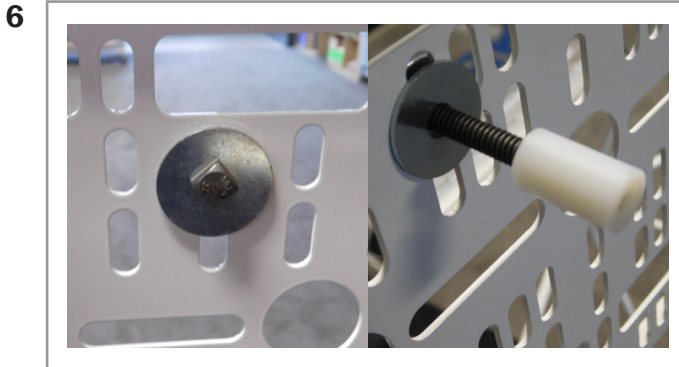
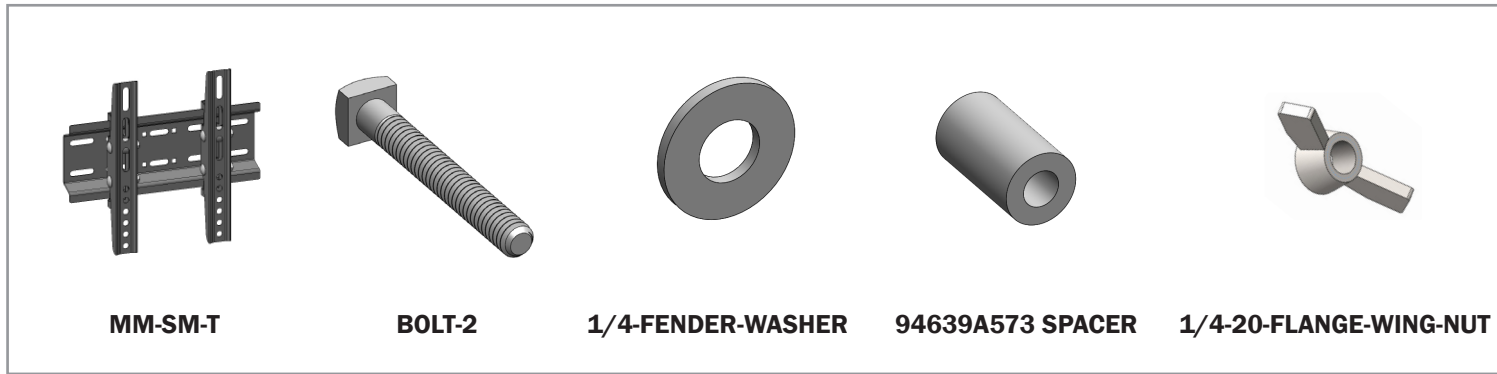

Slide the four BOLT-2s through the monitor mount with 1/4-FENDER-WASHERs on both sides of the mount. Slide the SPACERS onto the BOLTS.



Apply the graphic to the frame as normal. Upon install, slide the MM-SM-T monitor bracket onto the BOLT-2s and secure in place by screwing on the 1/4-20-FLANGE-WING-NUTS.

Note: Remove the verticals from the bracket and attach to the monitor prior to assembly.

Attach the monitor (not included) as normal.

