

## PRODUCT DESCRIPTION

Expedite your banner stand setup time while adding lavish appeal with our newest EZ Tube fabric display - the EZ Extend! Customize a single-sided (choose white or black back fabric) or double-sided dye-sublimated stretch fabric print. To assemble, secure the longest vertical poles onto the black steel base using the included allen wrench. Add the bottom horizontal support pole and secure. Snap on the remaining vertical poles, then top frame with the curved bar to complete. Tilt or lay down the frame to swiftly drape with the pillowcase graphic. Using the industrial-sized zipper, zip underneath the bottom support pole, maximizing fabric tension.

DISPLAY DIMENSIONS	37.5"W x 114"H x 10"D
GRAPHIC SIZE	38" W x 114"H

## GRAPHIC MATERIAL

Stretch fabric

## GRAPHIC FINISHING

Sewn on left, right, and top with a zipper at the bottom

## DISPLAY CONSTRUCTION

Steel base with aluminum tube frame (1.125" / 28.5mm dia.)

## SHIPPING WEIGHTS & DIMENSIONS

Shipping Weight	16 lbs (stand only) 18 lbs (with graphic)
Shipping Dimensions	39.5"L x 11"W x 4"H

## LARGE QUANTITY FREIGHT

Freight Shipping	40 boxes per 48"L x 40"W x 49"H skid
Freight Weight	640 lbs (frame only) 676 lbs (frame and graphic)

## GRAPHIC TURN AROUND TIME

3 business days after proof approval

## AVAILABLE ACCESSORIES

36" Silver bag	EZ Tube LED Light - Silver or Black
<b>AVAILABILITY</b>	CA and PA

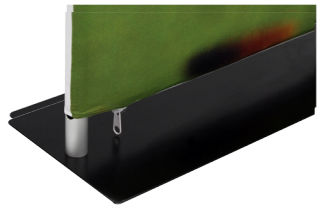
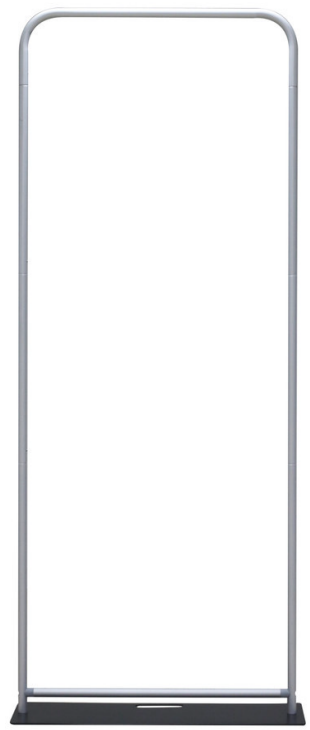

Shown with standard packaging



Shown with optional Silver bag



EZ Tube LED Light - Silver or Black

## PARTS LIST



Qty.1 - Steel base w/ allen key & screws

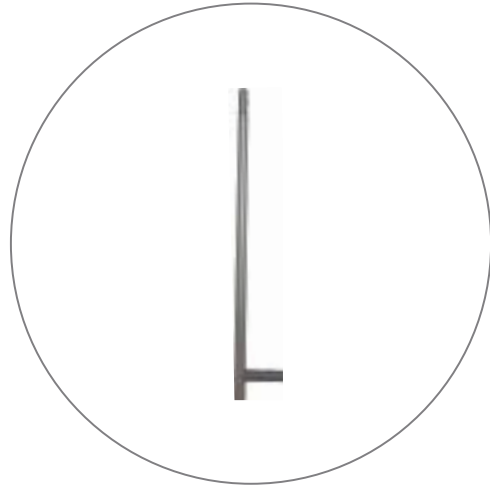

Qty.2 - 32" tube

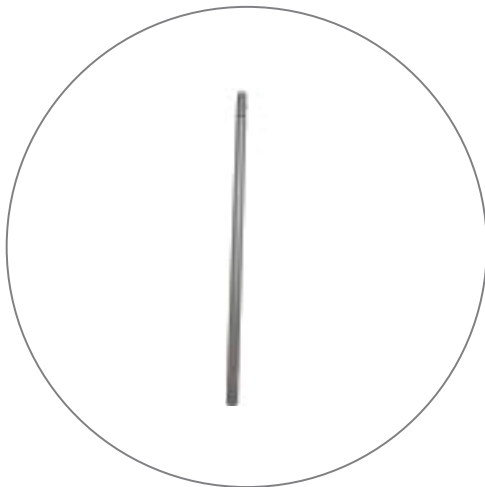

Qty.6 - 24" tube

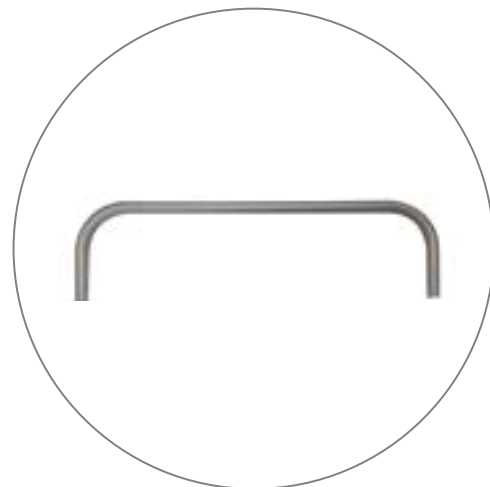

Qty.1 - 36" Top tube

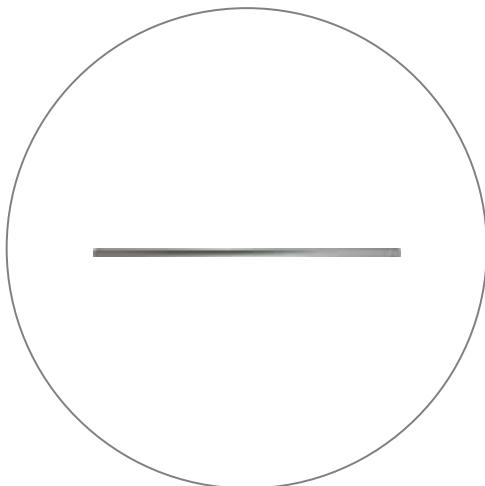

Qty.1 - 36" Bottom tube

## SET UP INSTRUCTIONS

# EZEXTEND FABRIC DISPLAY

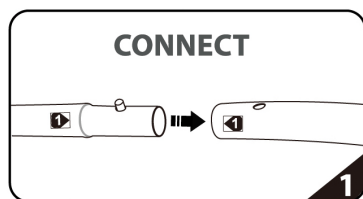
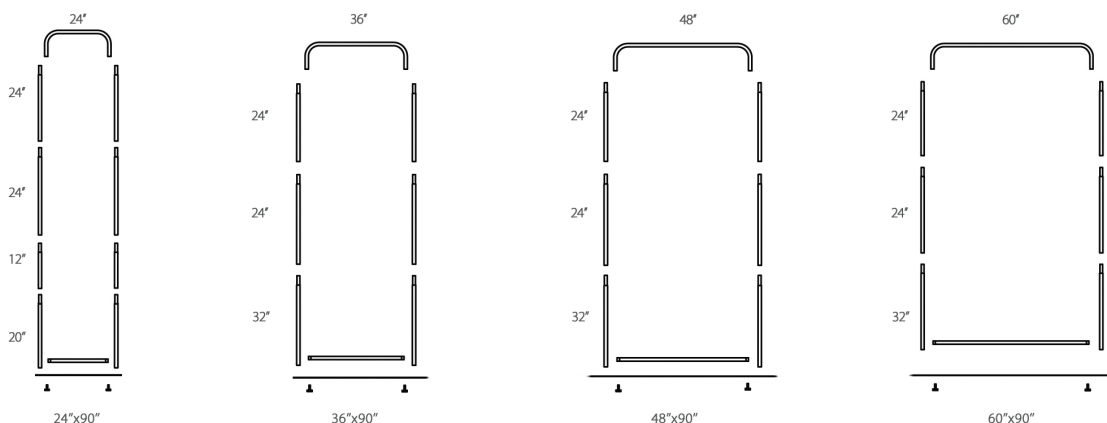

Connect numbered tubes together.

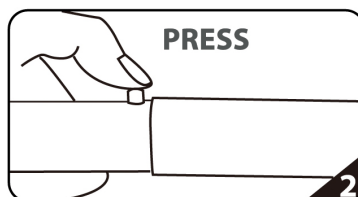

Snap tubes together.

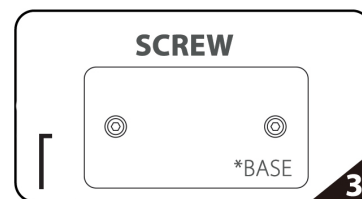

Screw base to tube with threaded bottom.

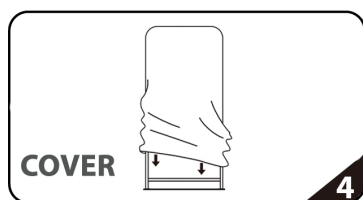

Cover frame with fabric graphic.

To assemble, secure the longest vertical poles onto the black steel base using the included allen wrench. Add the bottom horizontal support pole and secure. Snap on the remaining vertical poles, then top frame with the curved bar to complete. Tilt or lay down EZEXTEND to swiftly drape with the pillowcase graphic. Using the industrial-size zipper, zip underneath the bottom support pole, maximizing fabric tension.

