

# CSNR-43FS

## Set Up Instructions

**Step 1:** Assemble all straight pipes with bungee cords by pushing and pulling together.

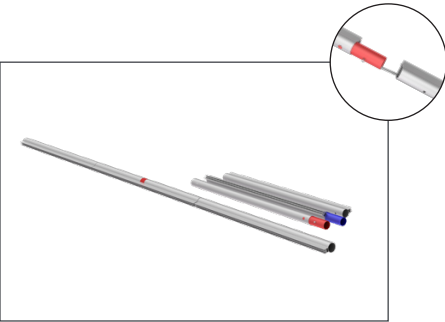

**Step 2:** Connect all corner sections to straight sections of the frame by matching color on pipes.

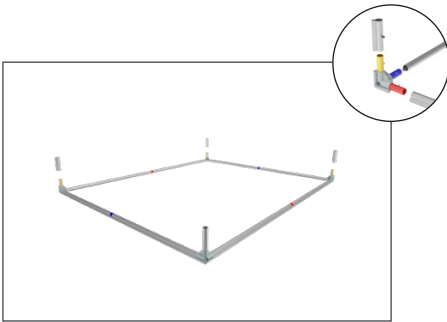

**Step 3:** Build two outer frames and connect top and bottom frames together in the corners with small connecting pipes.

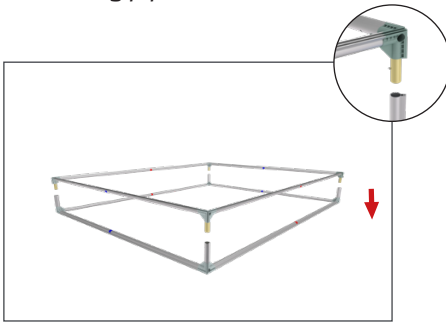

**Step 4:** At the top of the frame attach cable to left and right side. Tighten or loosen with hand pull.

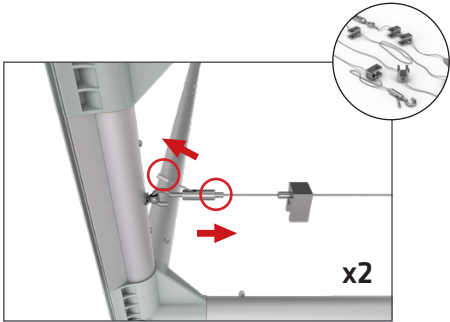

**Step 5:** Move to the center of cable and hand tighten remaining turn buckle to remove any remaining slack. Do not over tighten.

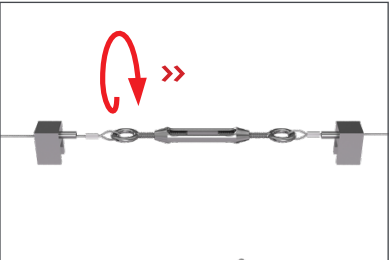

**Step 6:** Start in one corner of the frame and push the silicone edge of graphic into the inside groove. Insert for 4-6 inches in both directions. Repeat on all corners.

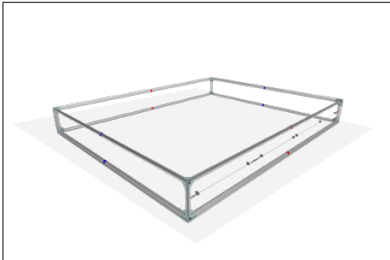

**Step 7:** Continue inserting silicone edge of graphic into the frame working towards the center of frame on each side. Do not over pull or stretch.

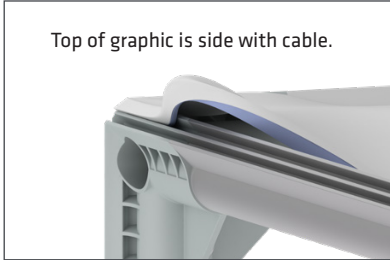
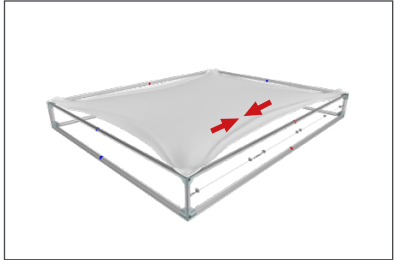

**USE DROP CLOTH TO PROTECT GRAPHICS:**  
Unfold drop cloth and place on smooth flat surface. Install graphics on top of drop cloth to keep clean. Do not walk on plastic or graphics with dirty shoes.



# CSNR-43FS

## Set Up Instructions

**Step 8:** Completed graphic frame for front side.

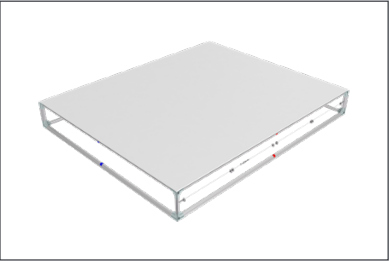

**Step 9:** Flip frame and graphic over. Note: make sure you are using the drop cloth and working on a smooth surface to prevent damage to your graphic.

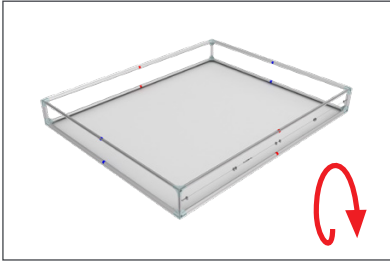

**Step 10:** Take out the LED Lights and **gently** unroll on the graphic with lights face down. **WARNING! Do not drag lights across ground or it could break the LED lights.**

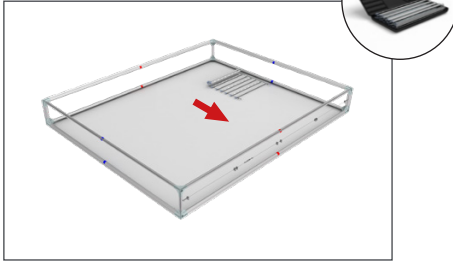

**Step 11:** Attach Light Array at top of frame onto wire harness clips.

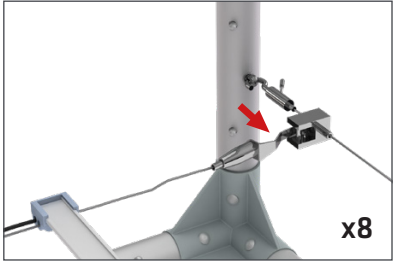

**Step 12:** Repeat step 11 until all Light Arrays are attached. Lights Arrays do not attach to bottom of frame, but hang under their own weight in final upright position.

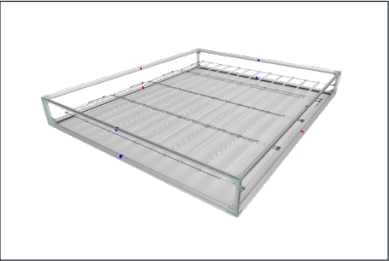

**Step 13:** Repeat Steps 6 and 7 to attach printed graphic for double-sided display or light block panel for single-sided display.

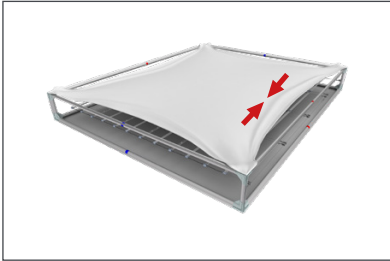

**Step 14: Turn. Position. Lock.** Insert tensioning pole into the bottom of display. Keep the pole flat until the entire pole fits inside the frame. **Turn** the pole 45°. **Position** and

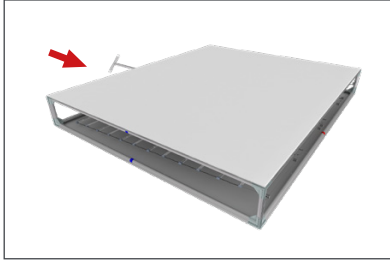

push pole onto the red indicators at top of frame. **Lock** the bottom of the pole by firmly sliding or knocking the pole into place over red indicators.

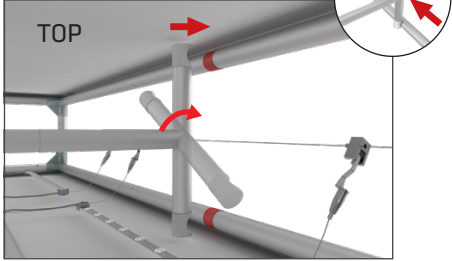

# Set Up Instructions

# CSNR-43FS

**Step 16:** Insert feet into 4 corners of the frame base.

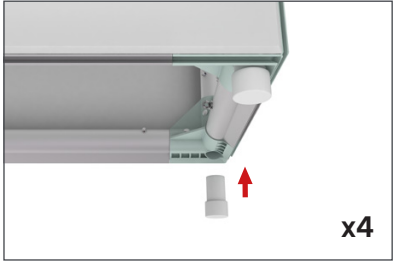

**Step 17:** Attach two LED Light Arrays to one power supply. Stand display into upright position over top of power supply with power cord showing.

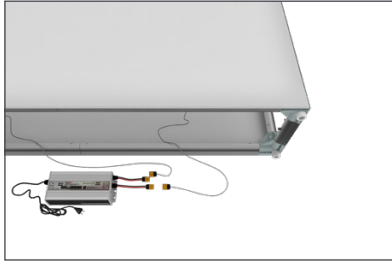

**Step 18:** With display in upright position, insert silicone edge of graphic into groove of frame. Start at opposite corners first, then work your way around entire edge.

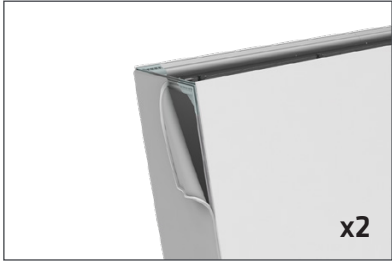

**Step 19:** Move display into position and plug power cords into outlet to illuminate display.

