

Set Up Instructions

CSNR-33FS

Step 1: Assemble all straight pipes with bungee cords by pushing and pulling together.

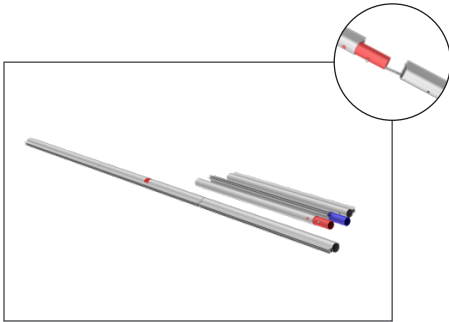

Step 2: Connect all corner sections to straight sections of the frame by matching color on pipes.

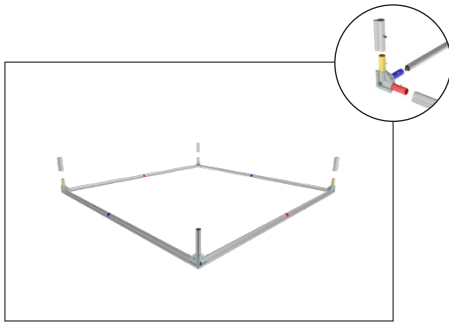

Step 3: Build two outer frames and connect top and bottom frames together in the corners with small connecting pipes.

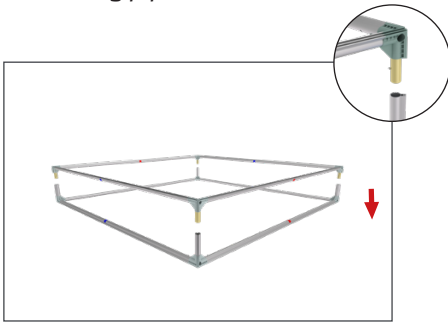

Step 4: At the top of the frame attach cable to left and right side. Tighten or loosen with hand pull.

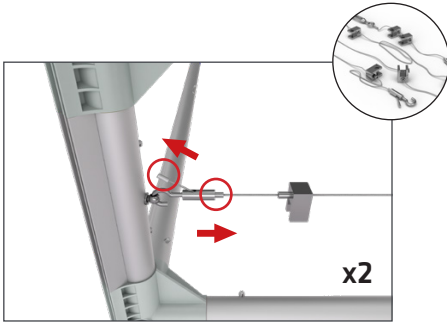

Step 5: Move to the center of cable and hand tighten remaining turn buckle to remove any remaining slack. Do not over tighten.

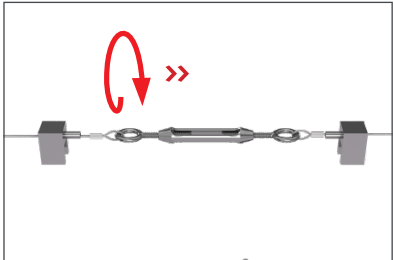

Step 6: Start in one corner of the frame and push the silicone edge of graphic into the inside groove. Insert for 4-6 inches in both directions. Repeat on all corners.

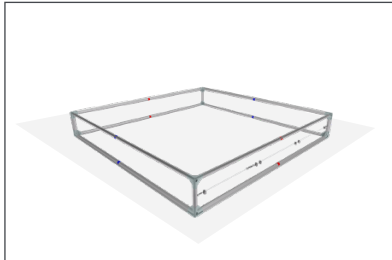

Step 7: Continue inserting silicone edge of graphic into the frame working towards the center of frame on each side. Do not over pull or stretch.

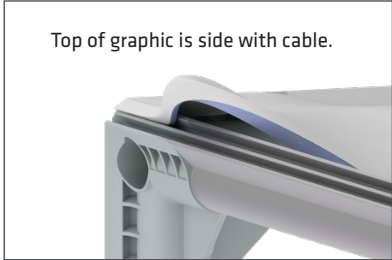
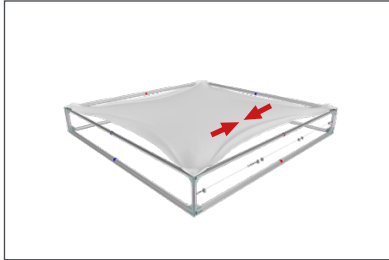

USE DROP CLOTH TO PROTECT GRAPHICS:
Unfold drop cloth and place on smooth flat surface. Install graphics on top of drop cloth to keep clean. Do not walk on plastic or graphics with dirty shoes.



Set Up Instructions

CSNR-33FS

Step 8: Completed graphic frame for front side.

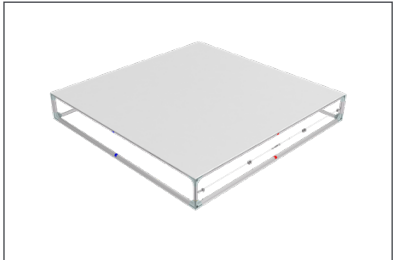

Step 9: Flip frame and graphic over. Note: make sure you are using the drop cloth and working on a smooth surface to prevent damage to your graphic.

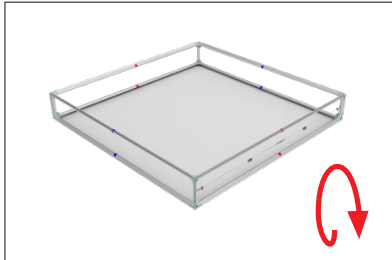

Step 10: Take out the LED Lights and **gently** unroll on the graphic with lights face down. **WARNING! Do not drag lights across ground or it could break the LED lights.**

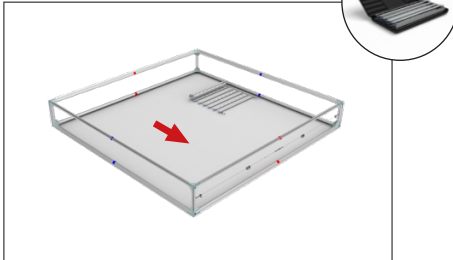

Step 11: Attach Light Array(s) at top of frame onto wire harness clips.

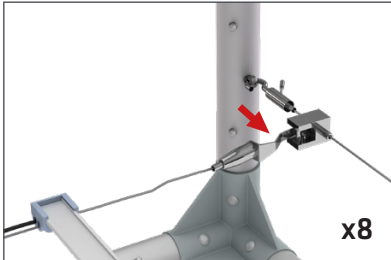

Step 12: Repeat step 11 until all Light Arrays are attached. Lights Arrays do not attach to bottom of frame, but hang under their own weight in final upright position.

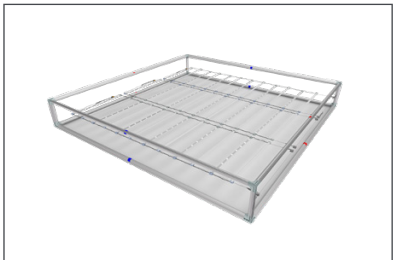

Step 13: Repeat Steps 6 and 7 to attach printed graphic for double-sided display or light block panel for single-sided display.

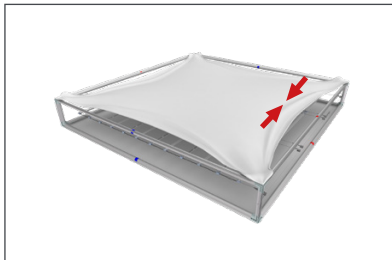

Step 14: Turn. Position. Lock. Insert tensioning pole into the bottom of display. Keep the pole flat until the entire pole fits inside the frame. **Turn** the pole 45°. **Position** and

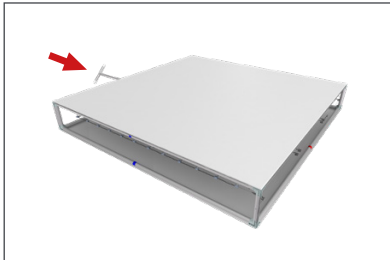

push pole onto the red indicators at top of frame. **Lock** the bottom of the pole by firmly sliding or knocking the pole into place over red indicators.

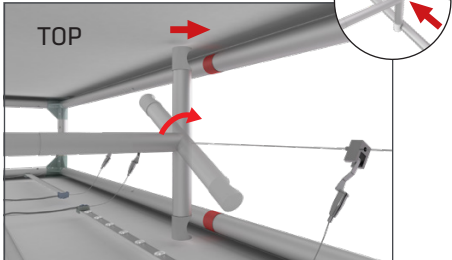

Set Up Instructions

CSNR-33FS

Step 16: Insert feet into 4 corners of the frame base.

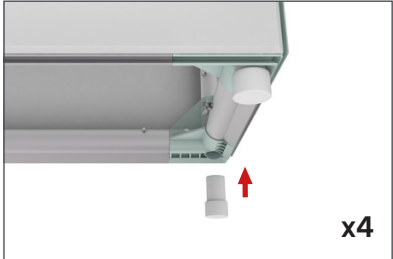

Step 17: Attach two LED Light Arrays to one power supply. Stand display into upright position over top of power supply with power cord showing.

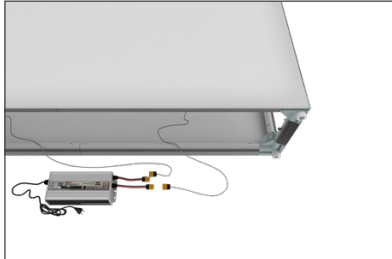

Step 18: With display in upright position, insert silicone edge of graphic into groove of frame. Start at opposite corners first, then work your way around entire edge.



Step 19: Move display into position and plug power cords into outlet to illuminate display.

