

## BLIMP TAPERED TRIO HANGING DISPLAY

Have a Question?

Please contact [support@tradeshowplus.com](mailto:support@tradeshowplus.com)

### SETUP INSTRUCTIONS

**Step 1:** Assemble the different frame sections by pushing and pulling pipes together.

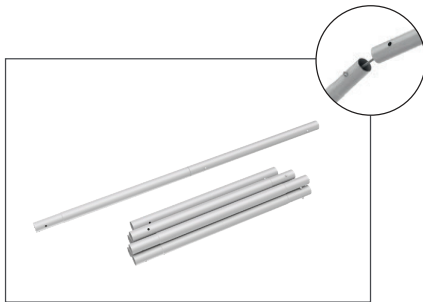

**Step 2:** Connect all corner sections to longer sections of the frame by matching shape symbols on pipes.

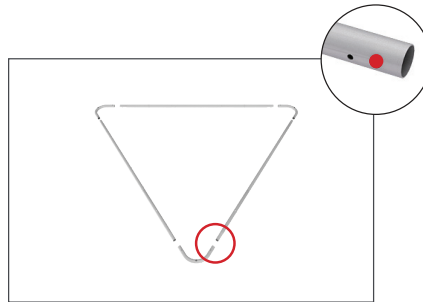

**Step 3:** Align two frames together making sure holes face each other.

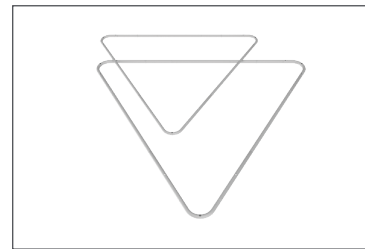

**Step 4:** Push all support poles into one frame. **Step 5:** Locate all the poles pushed into black grommets and place one end of a cable eyelet over those poles.

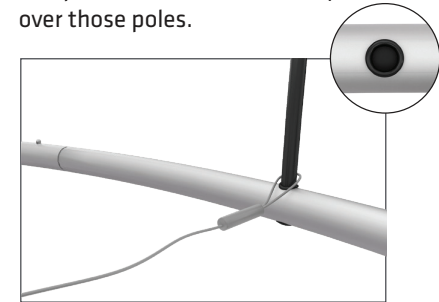

**Step 6:** Align top frame to bottom frame and push support poles into the frame. With some force connect the support poles in the middle to complete.

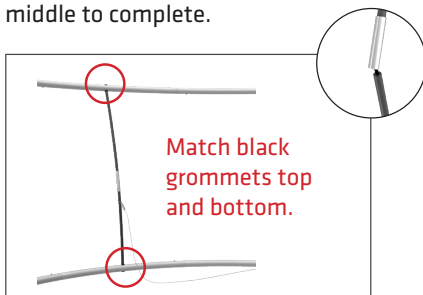

**Step 7:** Unzip print and place one frame inside. Position holes on frame to align with eyelets in graphic. Thread cable through eyelet. Repeat for all eyelets.

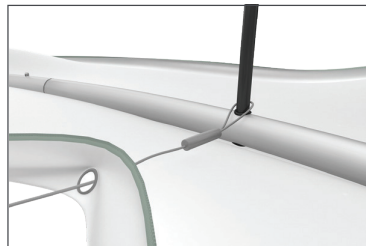

**Step 9:** Complete.

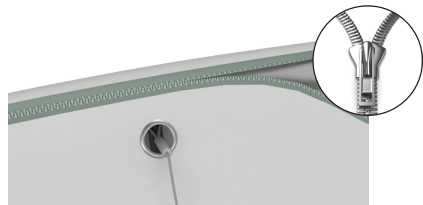

**Step 8:** Zip graphic closed around top of frame. Pull all cables out until inside loop is flush with eyelets. Attach all cables together at a single point for hanging.