

EMMO

GREEN YOUR LIFE

USER'S MANUAL



EMMO
Vovo

Safety Disclaimer

This manual contains important safety, performance and service information. Read and understand it along with the information provided during the on-delivery instructions before using the product, and keep it for reference. Ensure that you comprehend all instructions and safety notes/ warnings. Ensure the bike fit you properly before use. You might lose control if the bike is too small or too big for you.

Rider:

By choosing to ride an electric bicycle, you assume the responsibility for the risk of riding an e-bike. The rider is responsible to know and practice the rules of safe and responsible riding, as well as proper use and maintenance of the bicycle.

Riders must have the physical condition, reaction time and mental capability to ride and manage traffic, road conditions, and sudden situations. Riders should also familiarize themselves on local bylaws regarding riding an E-Bike.

If you have an impairment, hearing impairment, physical impairment, cognitive / language impairment, or a seizure disorder, consult your physician before riding any bicycle.

Before your 1st ride:

Failure to confirm proper installation, compatibility, proper operation or maintenance of and component or accessory can result in serious injury or death. Make sure that correct setup, tightening and torquing to recommended torque values have been completed on your bike.

Before the first ride, familiarize yourself with all the bicycles features. Practice and become proficient at shifting gears, applying the brakes, using the pedal-assist system and using the throttle in a controlled setting before riding in more risky conditions. If you prepare to ride at night, familiarize yourself with the lights and signals.

© 2020 Emmo Inc. All rights reserved. No texts, details, or illustrations from this manual may be reproduced or distributed, or become the subject of unauthorized use for commercial purposes. Should you discover any errors, we would be grateful if you would bring them to our attention.

Regular Inspection:

Please make sure the bike works properly and safely before each ride (Inspect key components, including but not limited to the brakes, brake sensors, throttle, and pedal assist sensor). Make sure all the hardware, such as the handle bar, hand grips, seat, seat post, pedals are secured in place. Have your bike inspected by a licensed mechanic on a regular basis depending on the conditions of the bike.

Do not use this product with standard bike trailers, stands, vehicle racks, or accessories that have not been tested for safety and compatibility and verified as safe and compatible with the bike by EMMO E-Bikes. Contact us if you have any question or concern.

Extreme riding:

E-Bikes and e-bike parts have strength and integrity limitations. Extreme riding should not be performed or you will risk damaging the components or becoming seriously injured or killed. This includes but not limited to jumps, stunts, or any riding that exceeds your capabilities.

In no event shall EMMO E-Bikes be responsible for any direct, indirect or consequential damages, including without limitation, personal injury, property damage, or economic losses, whether based on contract, warranty, negligence, or product liability in connection with their products.

MENU

About EMMO	_____	5
Rules and Regulations of Riding an E-Bike	_____	6
Parts Overview	_____	7, 8
Switches	_____	9, 10
Throttle	_____	11
<i>Lights & Signals</i>	_____	12, 13
<i>Speedometer</i>	_____	14
Kickstand & Centre Stand	_____	15, 16
Rear View Mirrors	_____	17, 18
How to turn on the bike with the key	_____	19
How to turn on the bike with the remote	_____	20
How to lock the steering	_____	21, 22
How to turn on/off the circuit breaker	_____	23, 24
How to charge	_____	25, 26
How to ride	_____	27
Safety Instructions	_____	28
Maintenance	_____	29
E-Bike Registration Form	_____	30
Appendix 1(How to charge a lithium battery)	_____	31
Appendix 2(Charger indicators)	_____	32, 33

ABOUT EMMO

Established in 2009, Emmo Inc. is a proud Canadian venture that is focused on creating a more sustainable future by providing high quality electric bicycles. We offer a wide variety of e-bikes that are suitable for leading a greener, and more stylish, way of living. Emmo e-bikes are priced competitively with other green solutions. At Emmo, you will get the best e-bikes and the most professional service.

EMMO

EMMO

GREEN YOUR LIFE

RULES and REGULATIONS

of riding an e-bike

According to Canada's Motor Vehicle Safety Regulations (**MVSR**). A qualified e-bike (defined as Power Assist Bicycle) must meet the following requirements:

- ***The e-bike must have operable pedals***
- ***Upper wattage limit for the motor is 500W.***
- ***Maximum speed of an e-bike is 32km/h.***

Other requirements include a permanently affixed compliance label from the manufacturer stating that the vehicle is a power-assisted bicycle under statutory requirements in force at the time of manufacture. Currently, there is no license, no insurance, and no vehicle registration required to operate a qualified e-bike according to federal legislation. E-Bike riders share the same rights and responsibilities as other road users.

However, provinces and local municipalities have the power to restrict the use of e-bikes. Most provinces require the rider to wear a helmet. Some provinces have special requirements with regard to the age limit to operate an e-bike, the type of helmet required, even the number of wheels and wheel size. In Ontario, typically, e-bikes are generally treated the same as regular bicycles. According to the Ministry of Transportation of Ontario (MTO), the age limit to operate an e-bike is 16 years old and above; the maximum weight of the bike is 120 kilograms (265 pounds); the bike must have a brake distance of less than 9 meters; Any modifications made to the bike's motor to create speeds greater than 32km/h are prohibited.

As the rules and regulations are subject to changes in different provinces and municipalities. Please check your municipal bylaw and see where you stand.

1. PARTS OVERVIEW

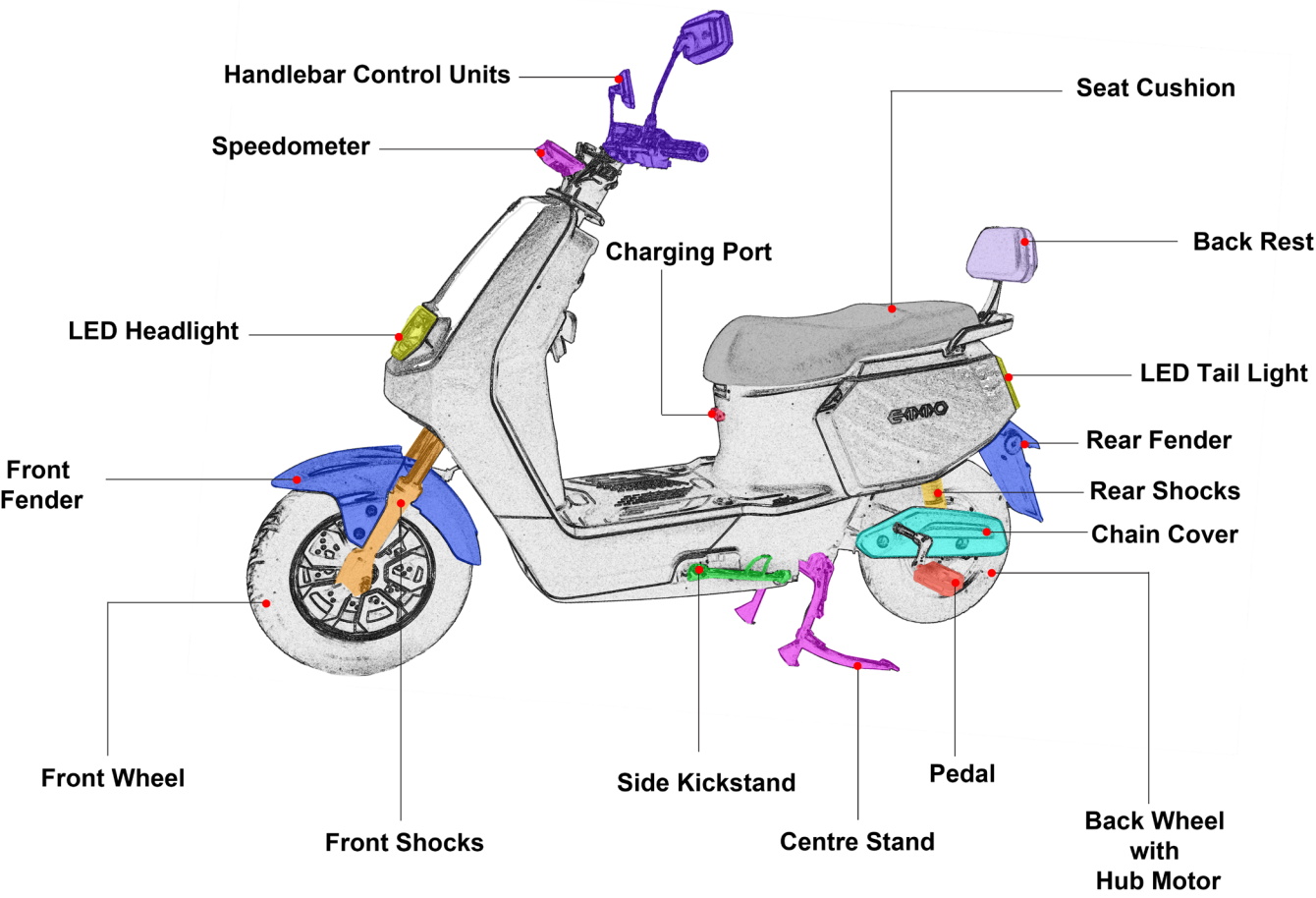

1. PARTS OVERVIEW

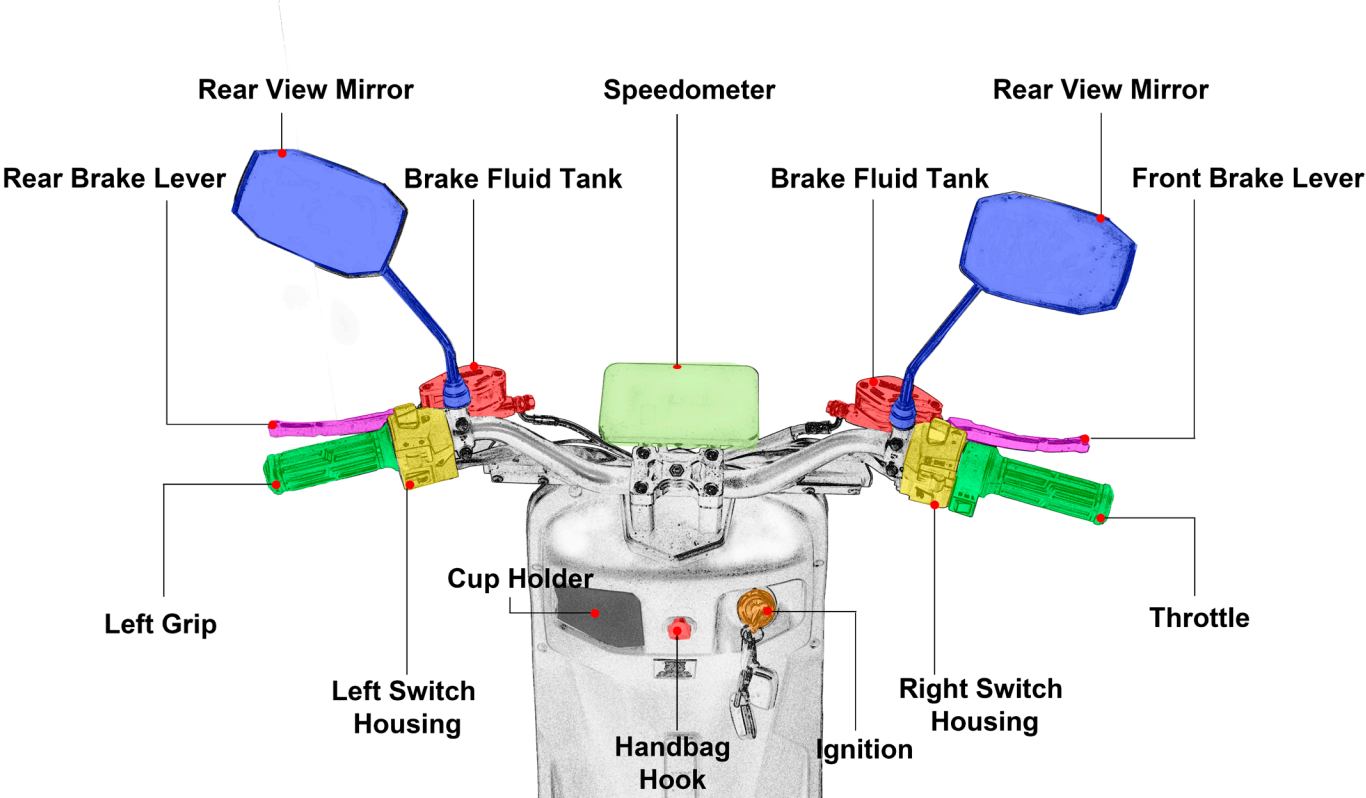

2. SWITCHES

The switch housings on the handlebar hold these switches that control the lights, signals, horn and etc.. They are also equipped with an LED light to light up the unit when the bike is on.

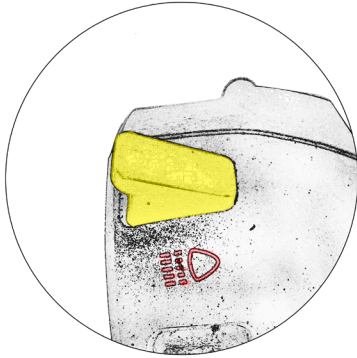

Headlight Flashing:

Press the button once to flash the high beam.

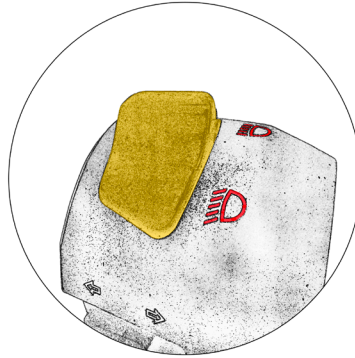

High/Low Beam Switch:

Press the button down will turn the corresponding beam on.

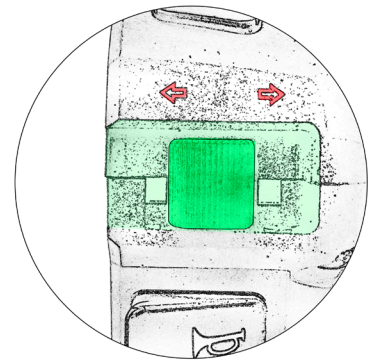

Turning Signal Switch:

Sliding the switch to the left/right will turn on the left/right side turning signals. Push the switch lever in to cancel the signals

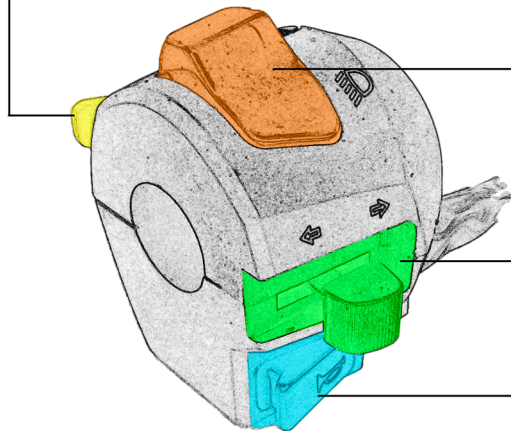

Left Switch Housing

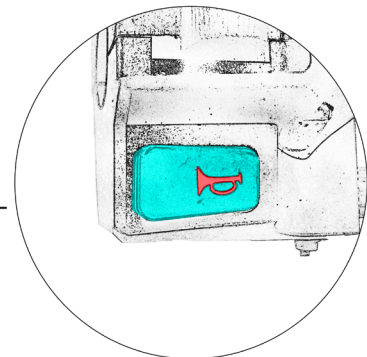

Horn Button:

Press the button to sound the horn.

2. SWITCHES

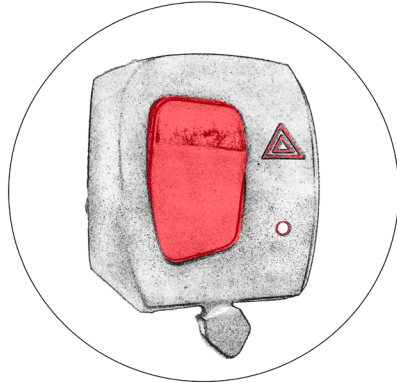

Emergency Harzard Lights:

Press the button to turn on all turning signal lights.

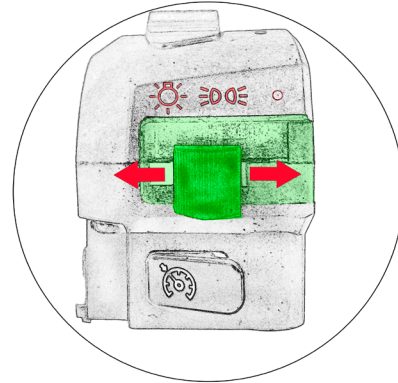

Headlight/Tail Light:

Slide the switch to turn on the headlight / tail light.

- :Off
- ☰☷☰ :Tail Light
- ☀ :Headlight + Tail Light

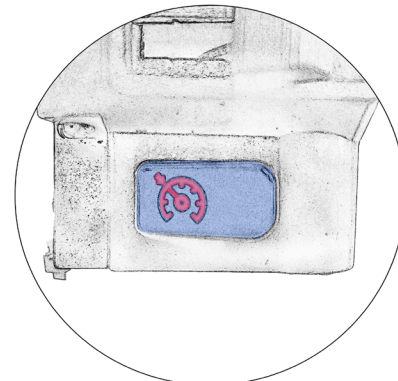
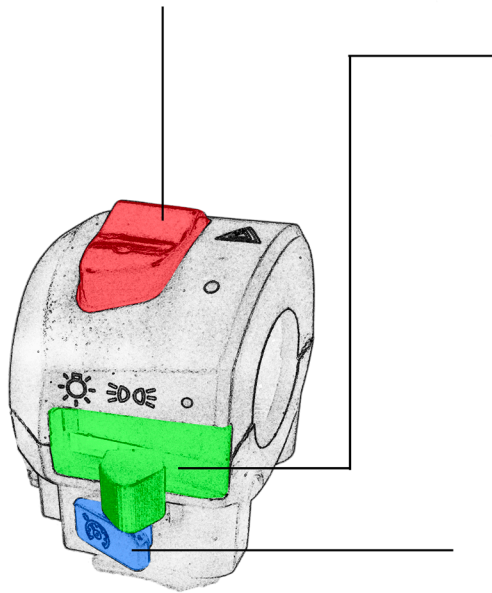

Cruise Control:

Press the button to activate the cruise control. To cancel the cruise function, press the button again or apply the brake.

Right Switch Housing

3. THROTTLE

The throttle controls the speed of the e-bike. As shown below, twist the throttle towards you to operate. With the help of the speed mode switch, you can also change the speed setting.

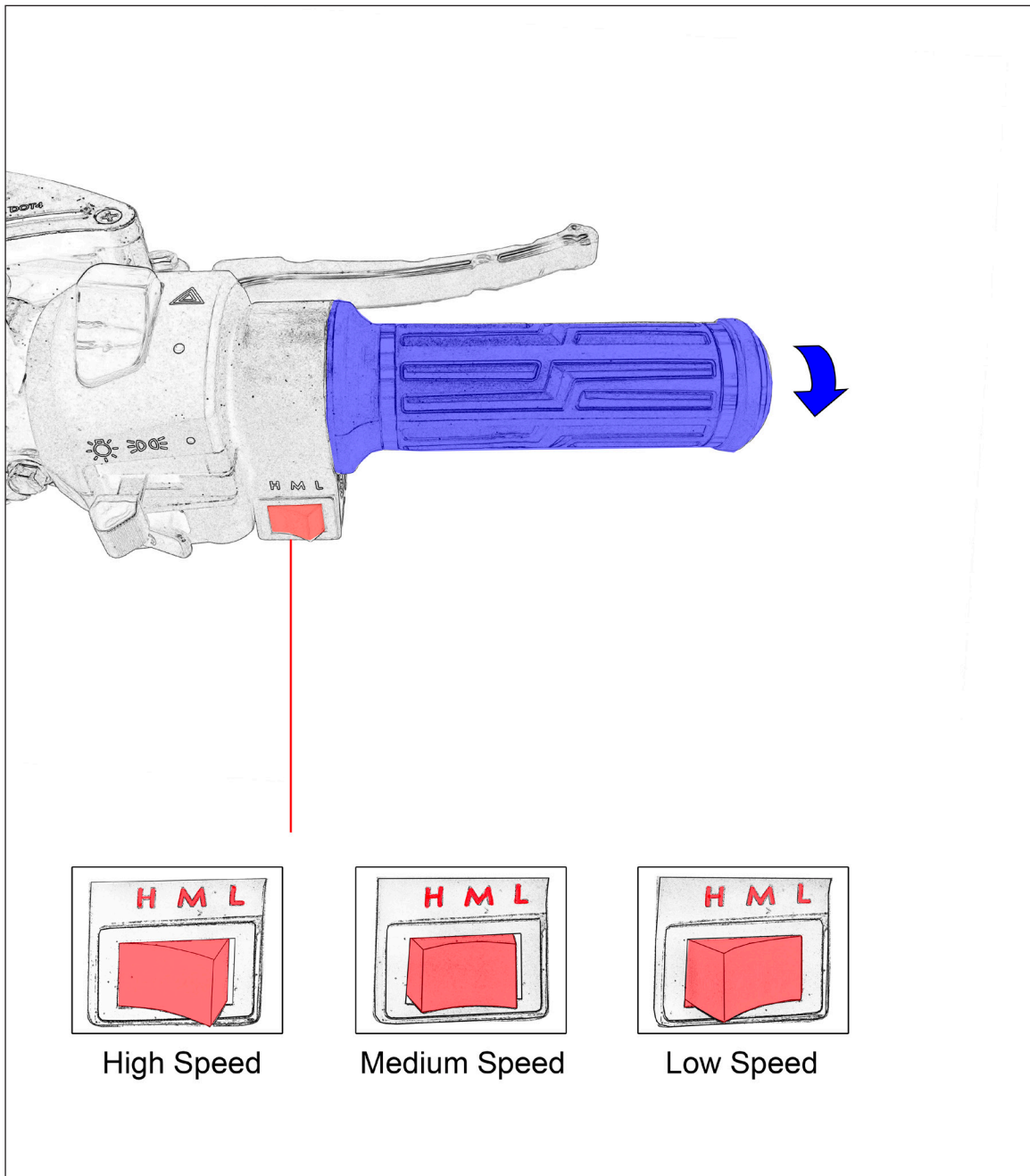

Warning:

- DO NOT turn the throttle if you are not ready to ride.

4. LIGHTS & SIGNALS

The headlight assembly has multiple operation modes - high beam, low beam and daytime running light, to accommodate your needs under different conditions.

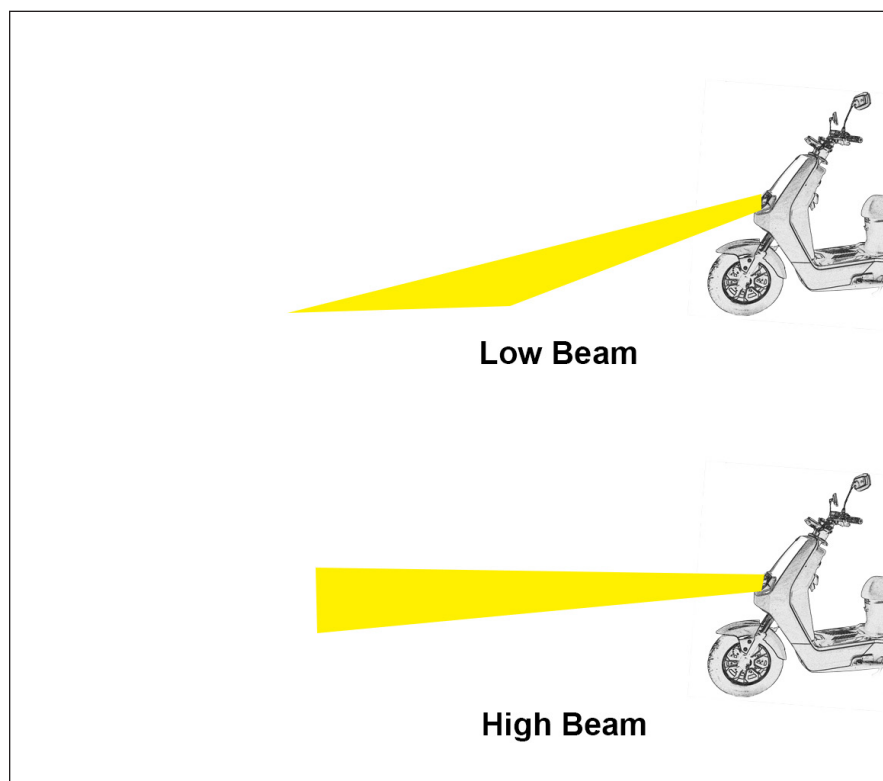
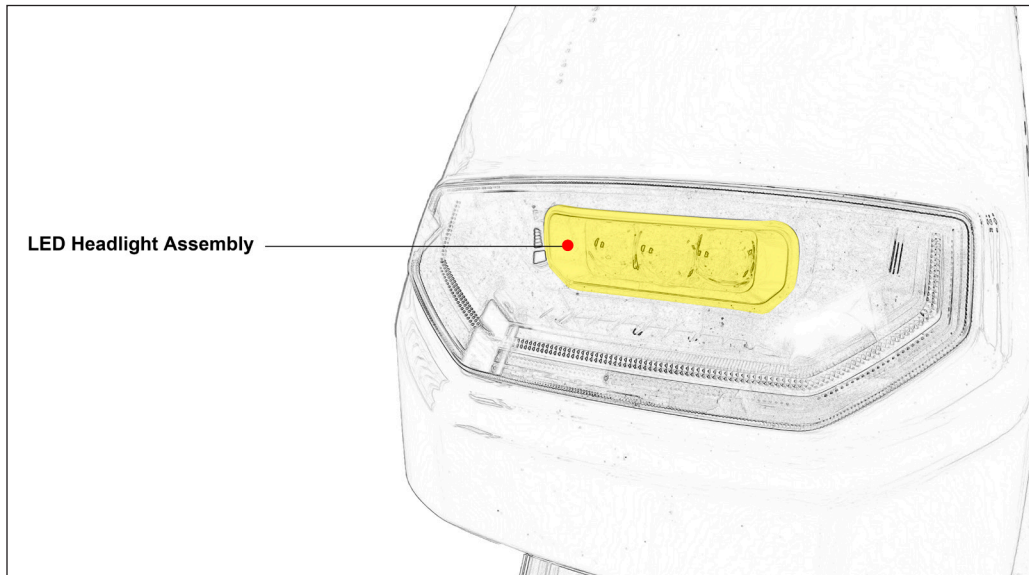

Note: Refer to Page 9-10 for instructions on how to turn on the high/low beam.

4. LIGHTS & SIGNALS

Tail light and brake light play an important role in signaling people behind. With the help of the turning signal lights, it is also easier for other road users to anticipate your intended route.

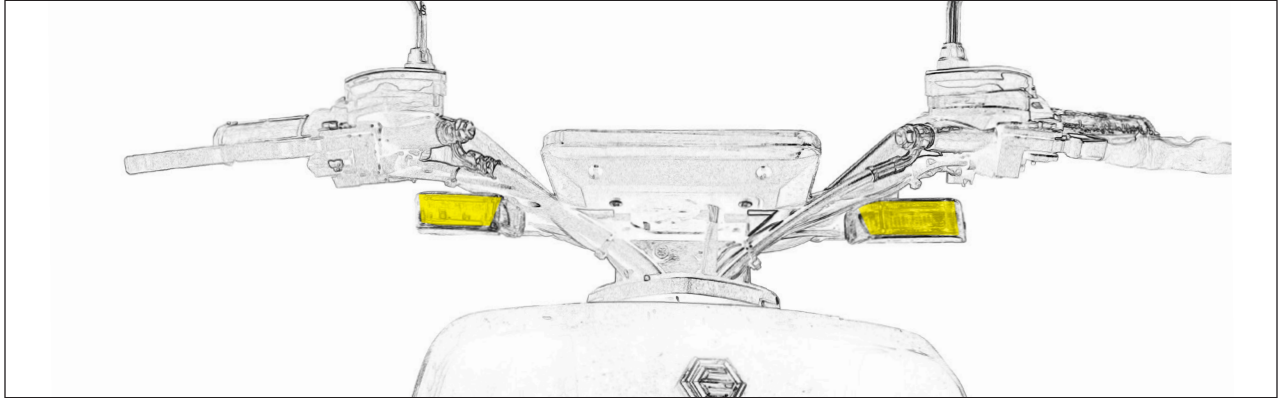

Front turning signal lights are located under the handle bar.

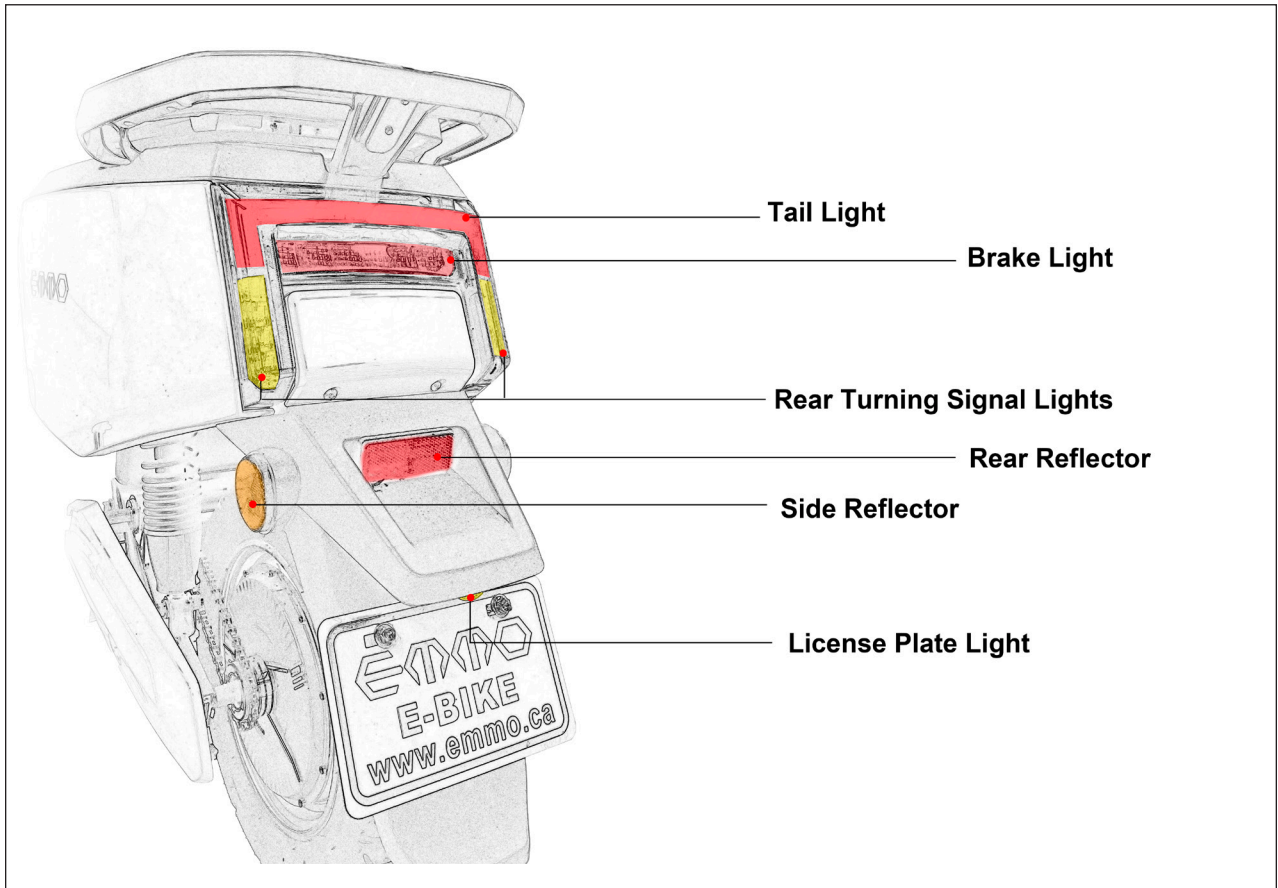

Tail Light

Brake Light

Rear Turning Signal Lights

Rear Reflector

Side Reflector

License Plate Light

Tail light, brake light and reflectors add to the visibility of you and the vehicle during the night time.

* For different versions, the turning signal lights may be different in design and function.

5. SPEEDOMETER

The speedometer let you know the working status of the bike. It provides information including the current speed, total travel distance, battery strength, and speed mode (3=high speed mode, 2=medium speed mode, 1=low speed mode).

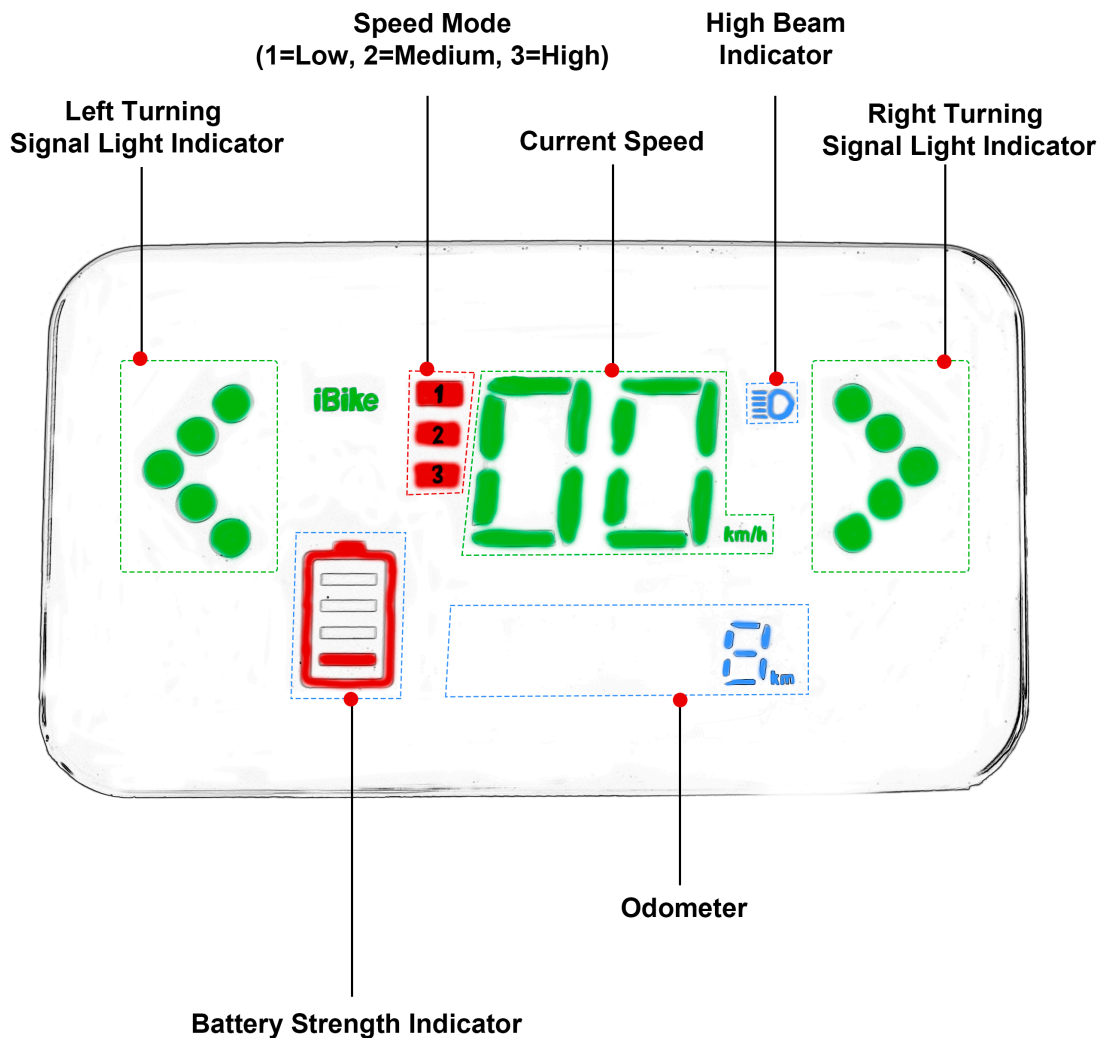

6. KICKSTAND & CENTRE STAND

The bike is equipped with a side kickstand and a centre stand, The side kickstand is easier to use. By contrast, to use the centre stand requires some techniques and practice, but the bike is more stable on the centre stand.

• Side Kickstand

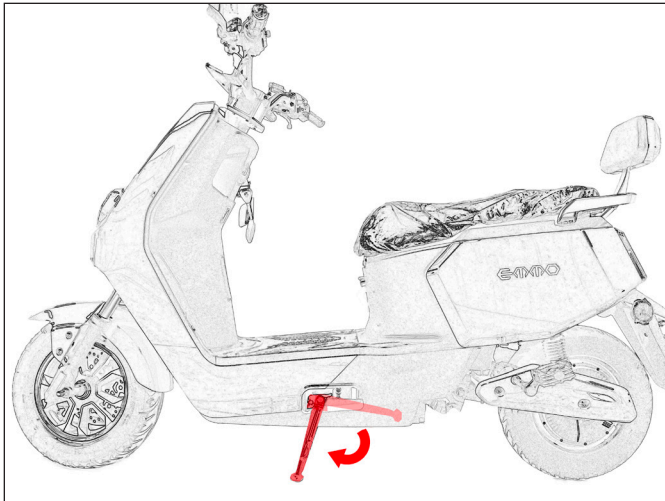

- Kick the side stand down and gently lean the bike on the side kickstand.

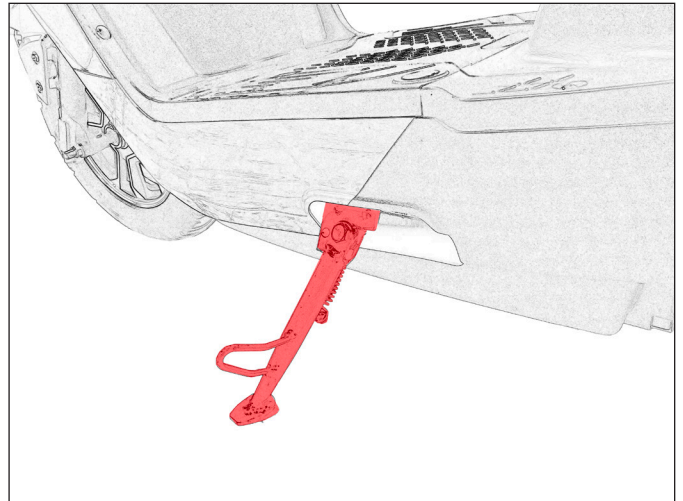

- Make sure it is stable before you leave your bike.

• Centre Stand

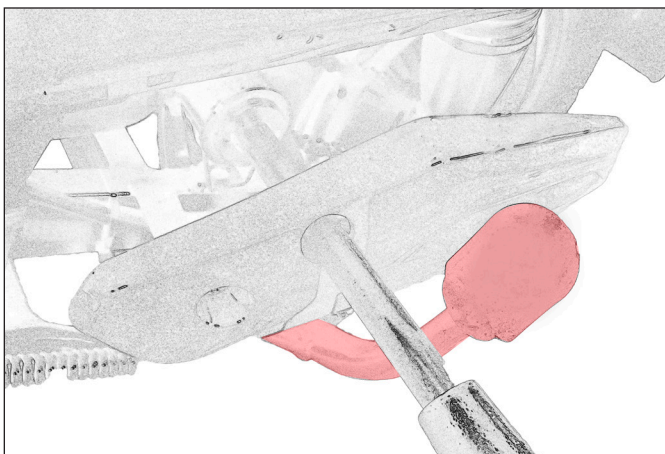

- Stand on the left side of the bike. The centre stand is under the swing arm cover.

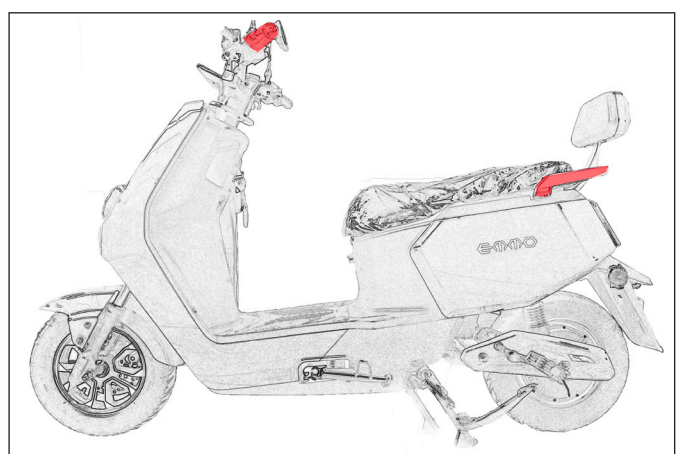

- Keep your balance, grab both ends of the bike (the handlebar & the rear rack).

6. KICKSTAND & CENTRE STAND

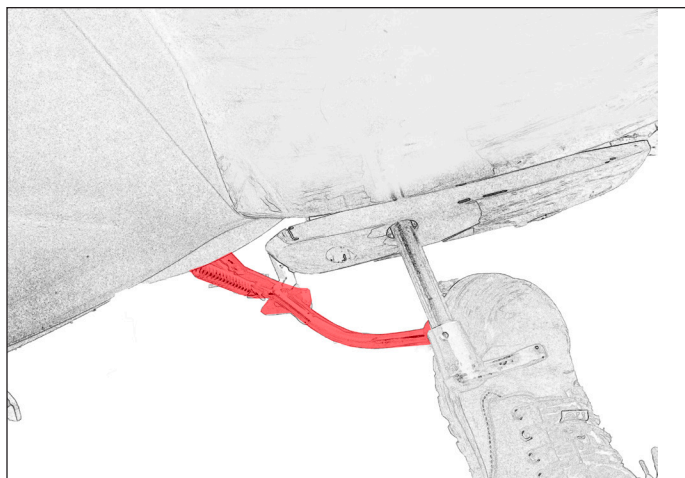

- Step on the centre stand peg firmly.

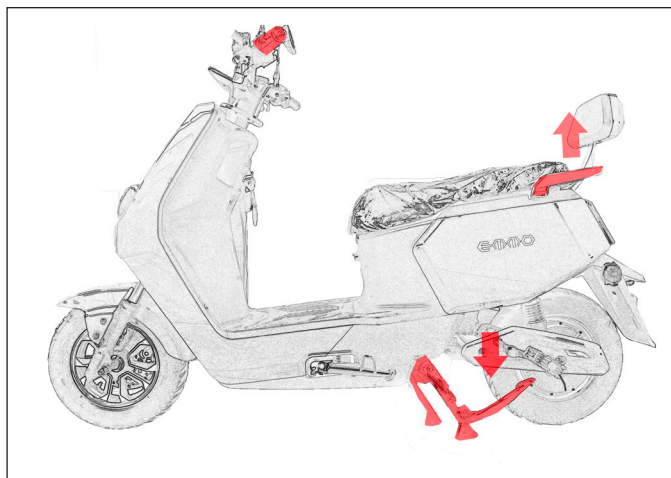

- Keep the bike in an upright position and slightly lift up the back of the bike.

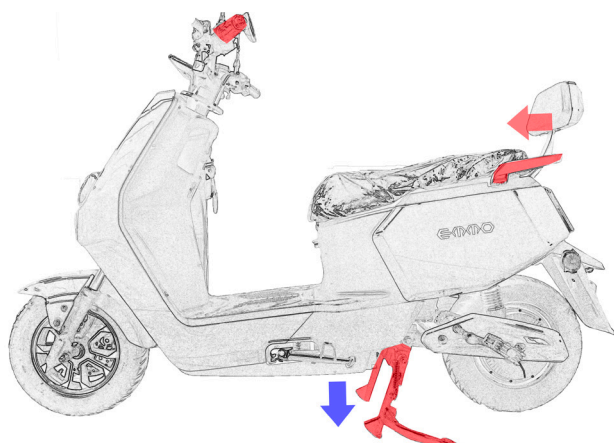

- To get the bike off the centre stand, put your left foot in front of the centre stand and gently push the bike forward.

Tips:

- Keep your balance when trying to put the bike on the centre stand.
- Keep the bike in the upright position at all time. Do not lean the bike towards either side.

Warning:

- Both side kickstand and centre stand should be kicked up before you ride the bike.
- Be careful when putting the bike on the centre stand. If you find it difficult to use the centre stand, visit your EMMO dealer for a more detailed demonstration on how to use the centre stand.

7. REAR VIEW MIRRORS

Rear view mirrors make it safer for you to check the traffic condition behind you. Please make sure the rear view mirrors are adjusted and secured properly. Check the rear view mirrors and your blind spots before you make a turn or overtake other vehicles.

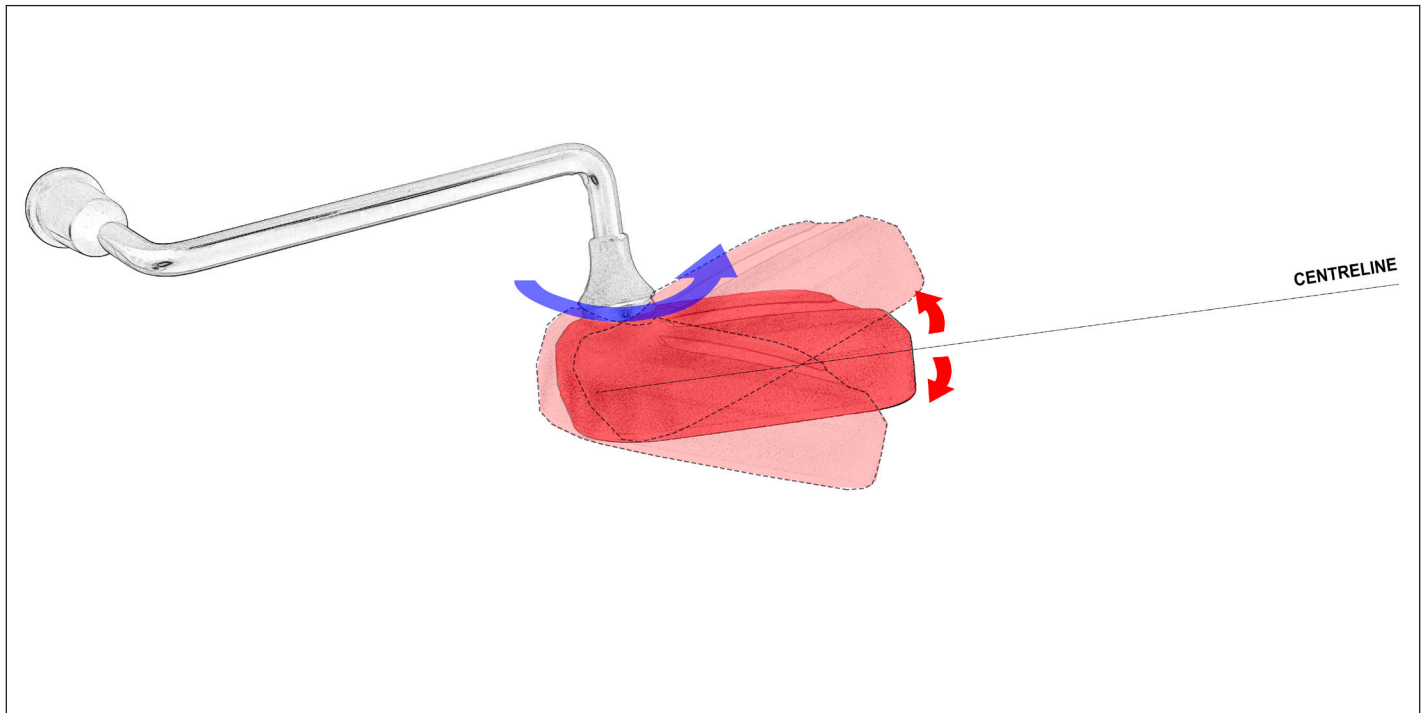

- The mirror can be tilted up and down for approximately 15 degree from the centreline (as showed by the red arrows).
- The mirror can also be rotated on the holding pole (as shown by the blue arrow).

7. REAR VIEW MIRRORS

-Adjustment

- *Tool needed: a 14mm wrench.*

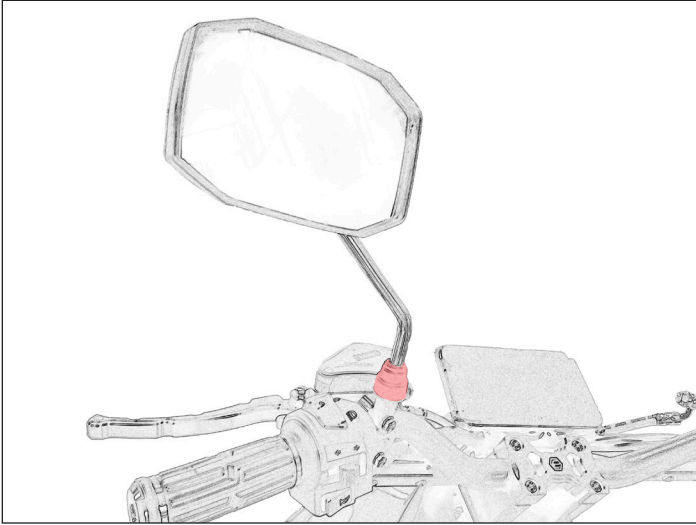

- In order to adjust the mirror, the nut that fixed the mirror should be loosened first.

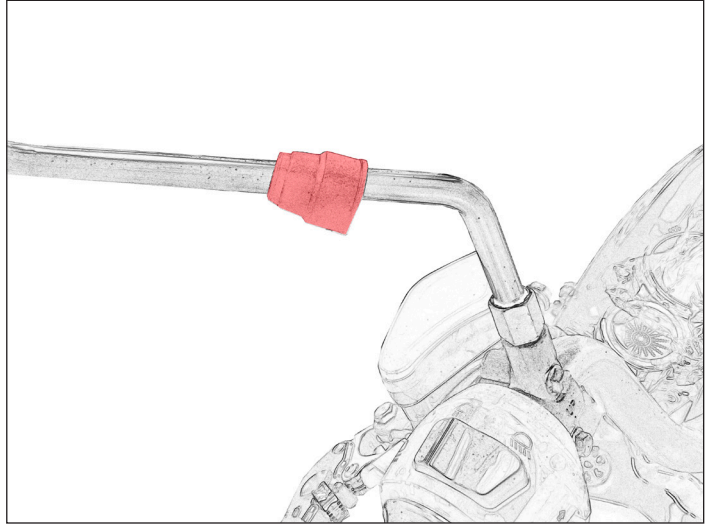

- The nut is covered by the plastic cap. Lift up the cap to expose the nut.

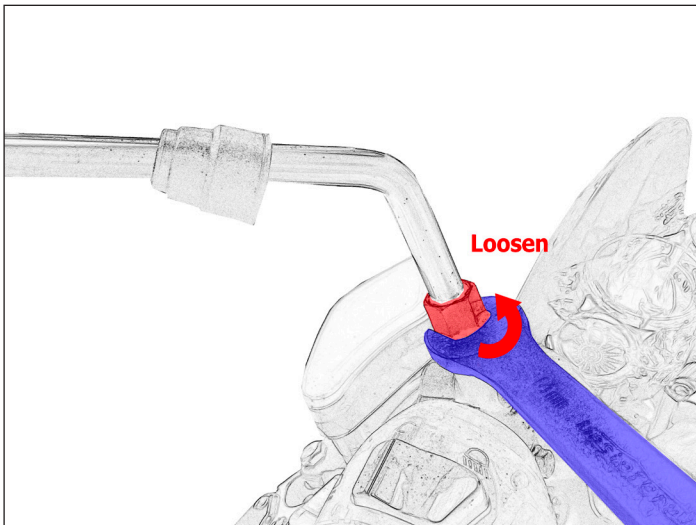

- Use the wrench and follow the direction indicated to loosen the nut slightly.

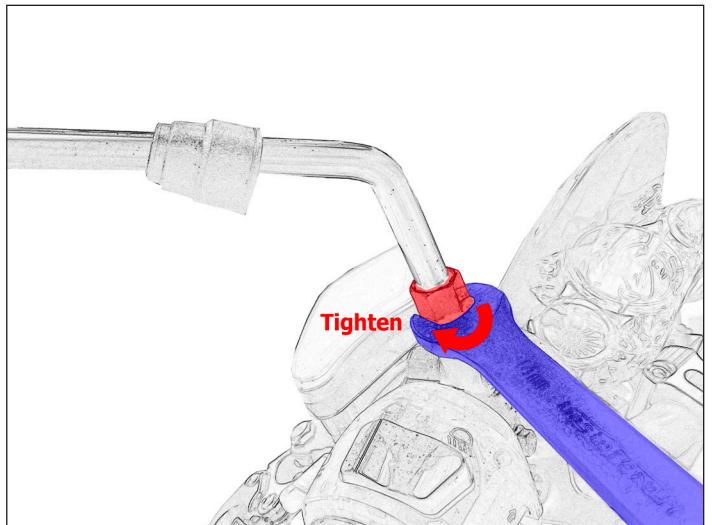

- Adjust the mirror to a preferred position and tighten the nut as shown.

Warning:

- DO NOT adjust the mirrors while you are riding the bike.
- Be careful when you tightened the nut to avoid damage to the threads and the mirror holders.

8. HOW TO TURN ON THE BIKE

via key ignition

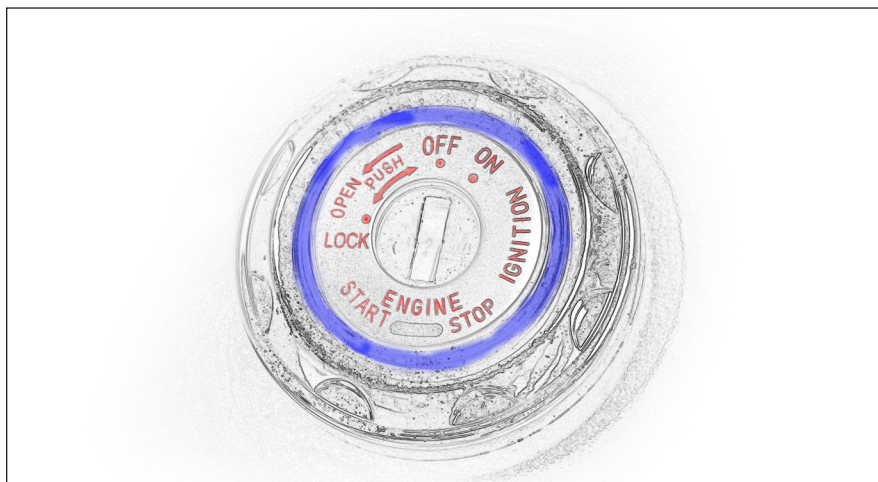

The main ignition is used to:

- Turn on/ off the bike.
- Lock/ Unlock the steering.
- Open the seat.
- One press quick start.

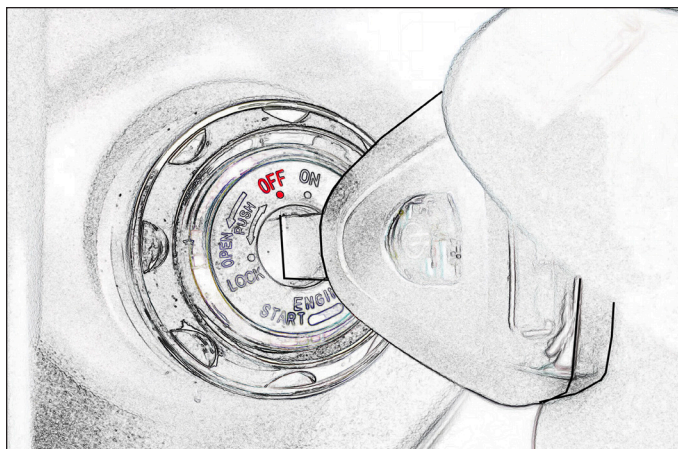

- Insert the key.

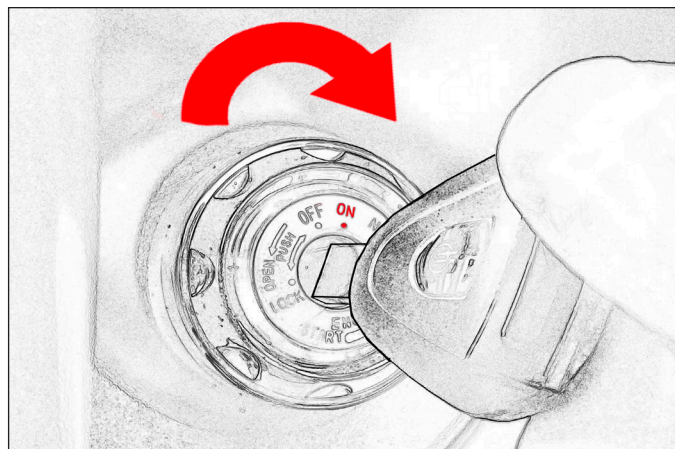

- Follow the marking on the ignition, turn the key to the right to turn on the bike.

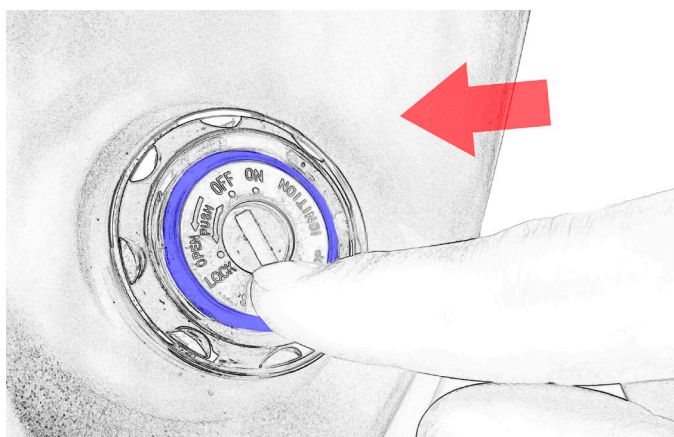

- If the quick start function is activated (refer to Page 21), you can turn on the bike by pushing the ignition.

9. HOW TO TURN ON THE BIKE

via remote

Remote Battery Indicator

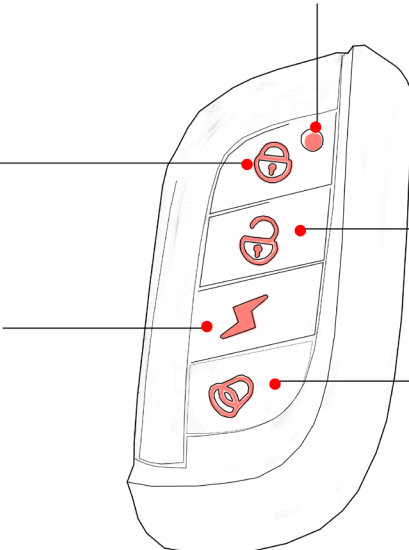

Lock Button:
Press the button once to activate the anti-theft alarm system, and disable the quick start button on ignition.

Power Button:
*Press the power button **twice** to turn on the bike with the remote.*

Unlock/Cancel Button:
Press the button once to cancel the alarm and activate the quick start function, or to turn off the bike if the bike is turned on with the remote or the quick start button.

Panic Button:
Press it once, the bike will sound 5 times.

Note:
By holding the unlock button, you can enable/disable the automatic alarm system, which will turn on the alarm after the bike is turned off for 15 seconds. If the bike 'beep' for one time, the automatic alarm system is activated. If the bike 'beep' for twice, the function is disabled.

Reminder:

- If the alarm system is on, please cancel the alarm before you turn on the bike.

10. HOW TO LOCK THE STEERING

For the safety of your bike, it is highly recommended to lock the steering when you park your bike in public spaces.

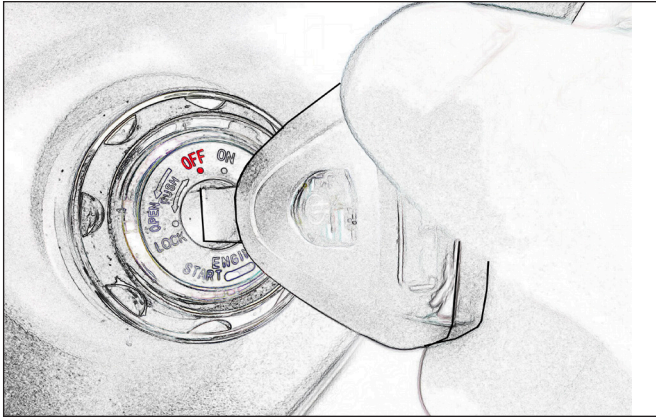

1. Turn the ignition off.

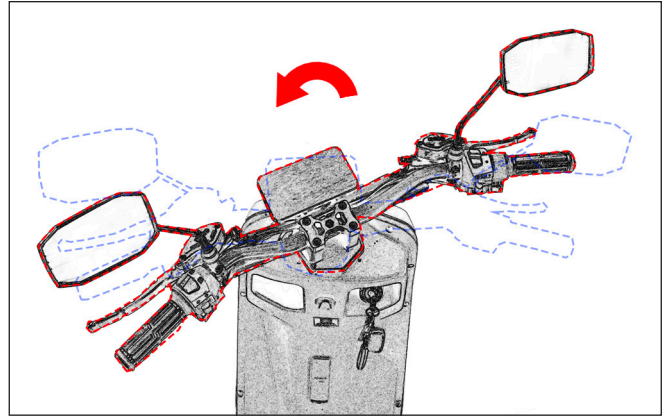

2. Turn the handlebar to the left.

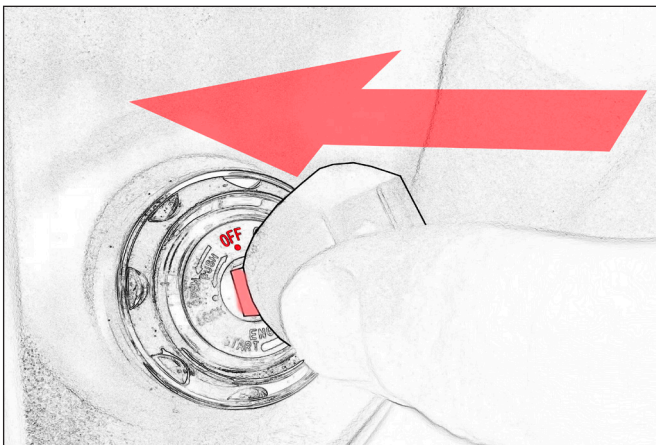

3. Push the key in.

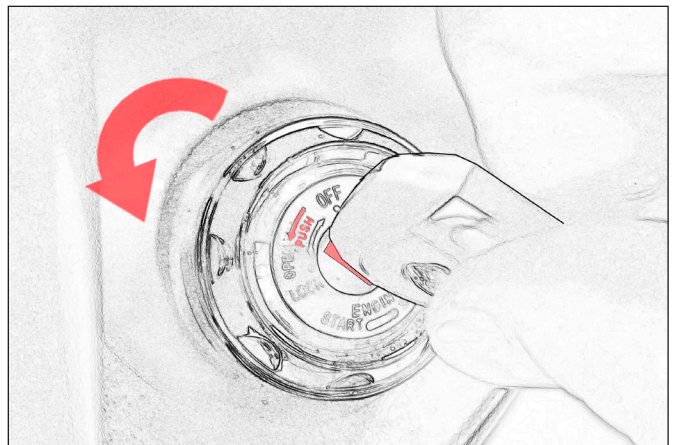

4. Follow the mark on the ignition, turn the key anti-clockwise.

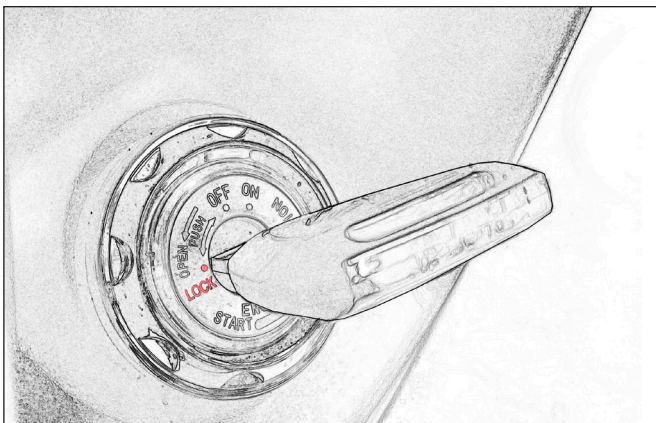

5. Remove the key.

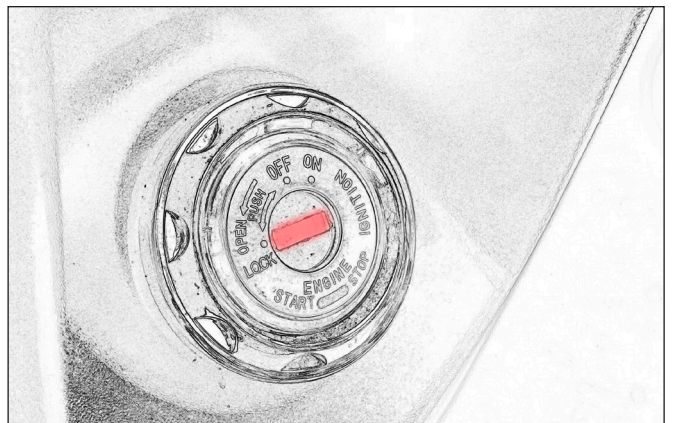

6. The steering is locked.

10. HOW TO LOCK THE STEERING

- Unlock the steering

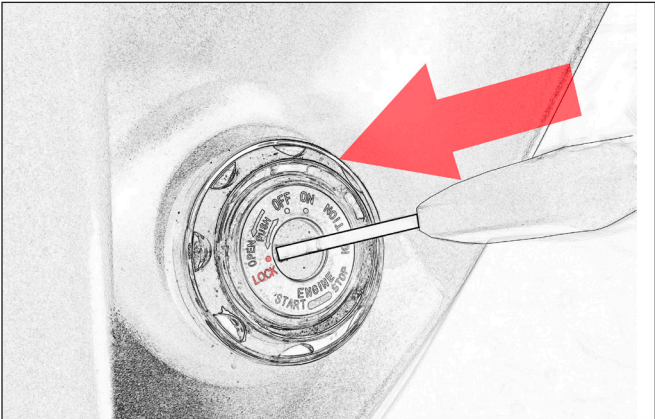

1. Insert the key.

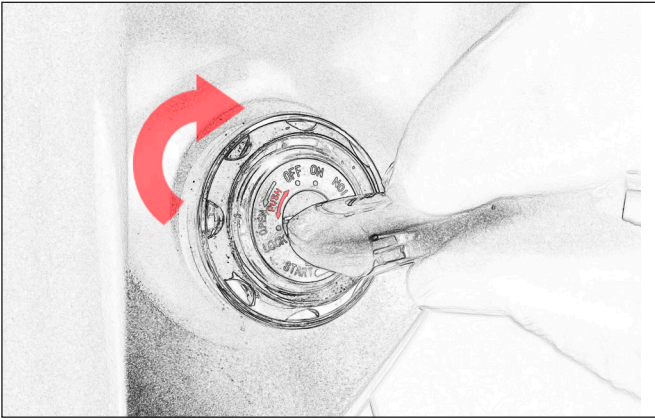

2. Push the key in and turn it clockwise.



3. When unlocked, the steering can be

11. CIRCUIT BREAKER

location & instructions

Located in the storage compartment under the seat, the circuit breaker is the main switch of the bike. When it is turned off, the battery will be disconnected from the system and you will not be able to use the bike, nor will you be able to charge the bike.

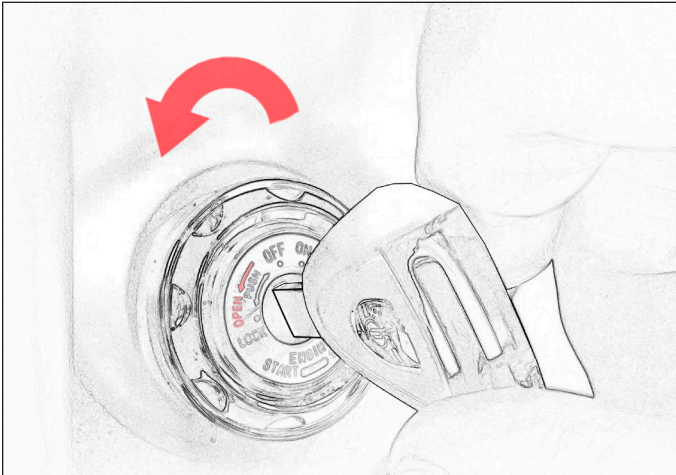

- The seat can be opened through the main ignition. Simply turn the key anti-clockwise (don't push the key.)

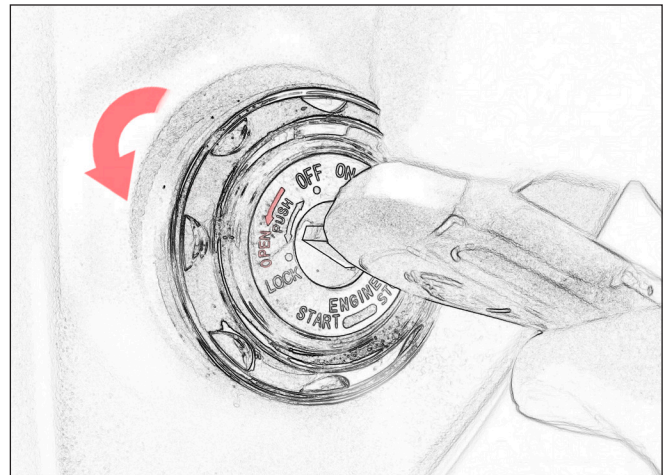

- The seat will pop up when unlocked.

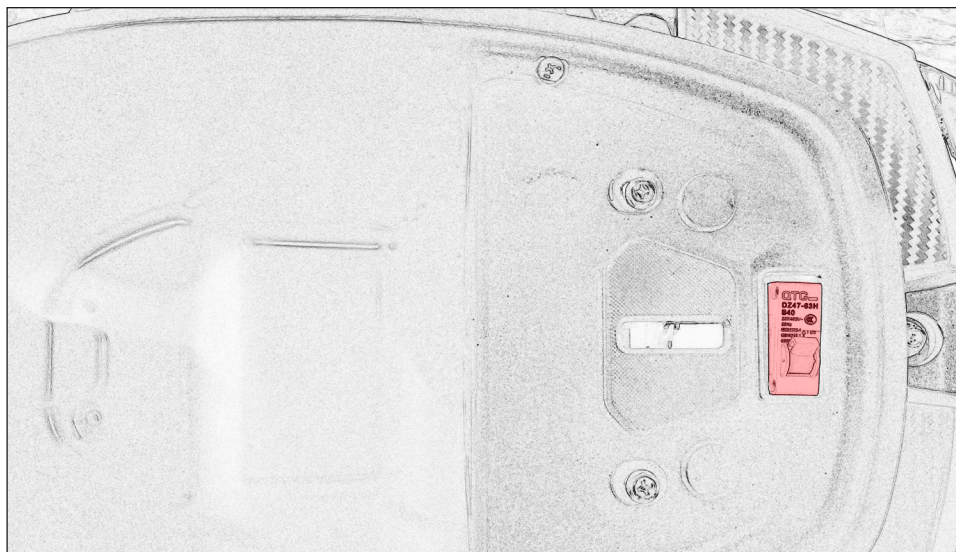

- Lift up the seat, the circuit breaker is next to the seat lock mechanism.

11. CIRCUIT BREAKER

location & instructions

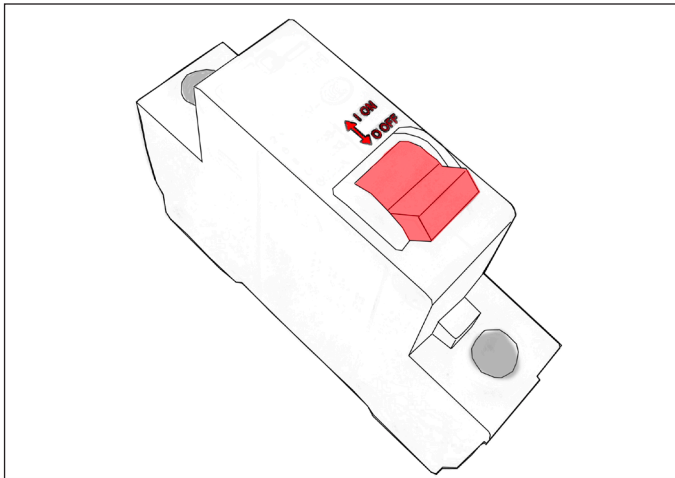

- Follow the marking on the circuit breaker, switch the circuit breaker off.

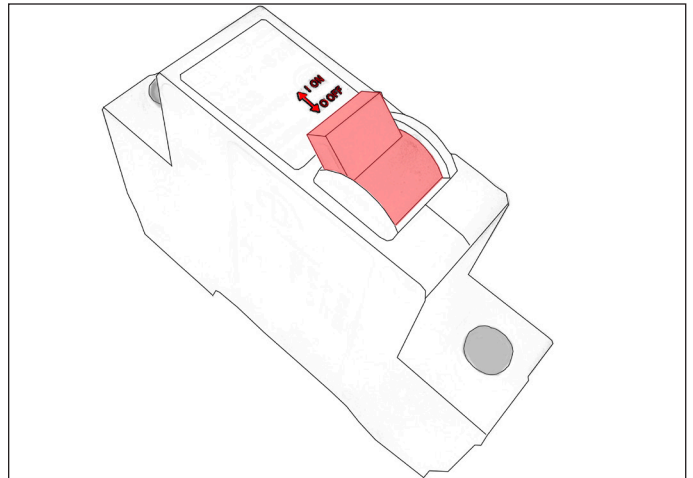

- Before you want to charge the bike/ use the bike, switch the circuit breaker on.

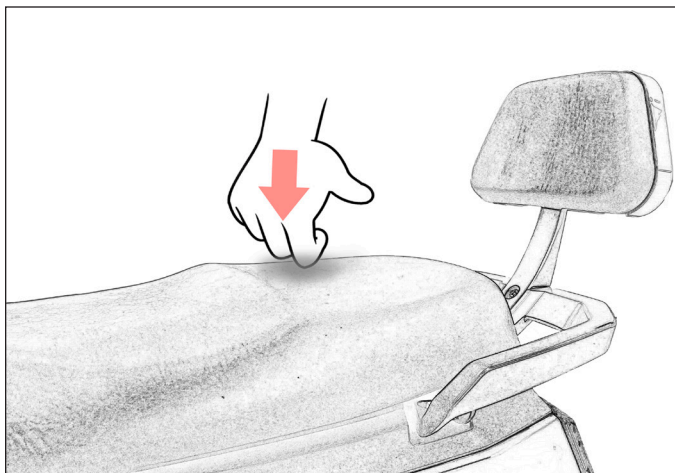

- Gently push the seat sushion down to lock it.

TIP:

- Pay attention to the location of the U shape latch under the seat. That is the pushing point when you lock the seat.

Warning:

- The wires inserted into circuit breaker could have high voltage output. DO NOT touch any bare wires. If you have any concern, contact your EMMO dealer for assistance.

12. HOW TO CHARGE

Charge the battery before the battery strength drops down to 20%. Before charging the bike, make sure you are using a compatible charger*. Failure to use a compatible charger will lead to danger.



- There are two cables coming out from the charger. One cable goes to the charging port on the bike, and the other goes to the regular 110V wall outlet.

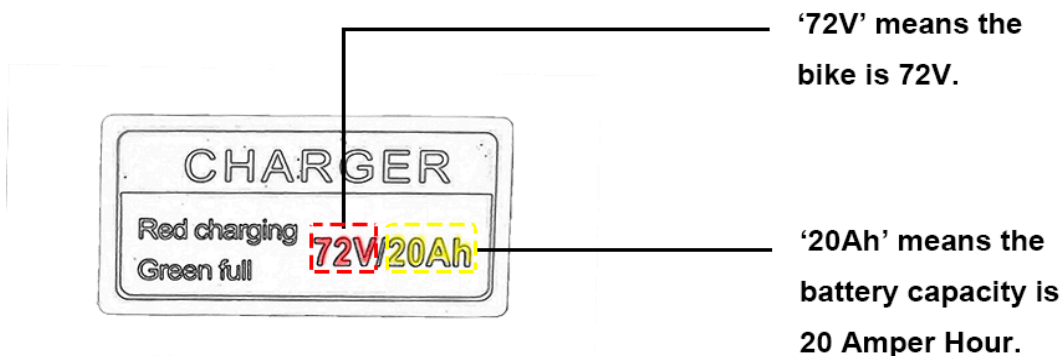

- On the charger, there is a sticker on the front indicating the voltage and capacity of the battery that the charger can be used for.

*Please refer to Appendix 1 for details of lithium battery and charger.

12. HOW TO CHARGE

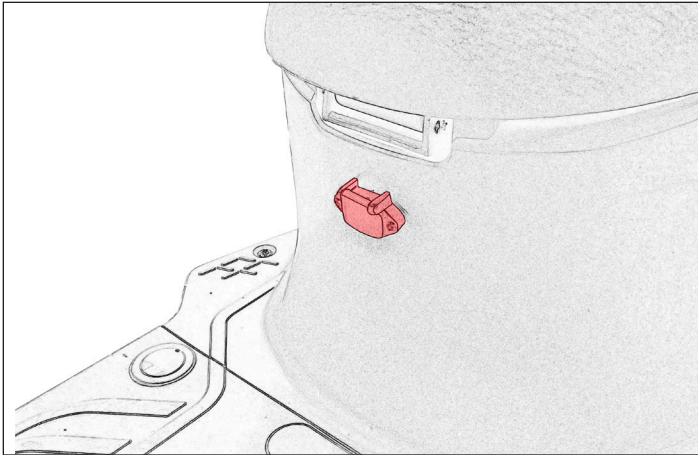

- The charging port is below the front of the seat.

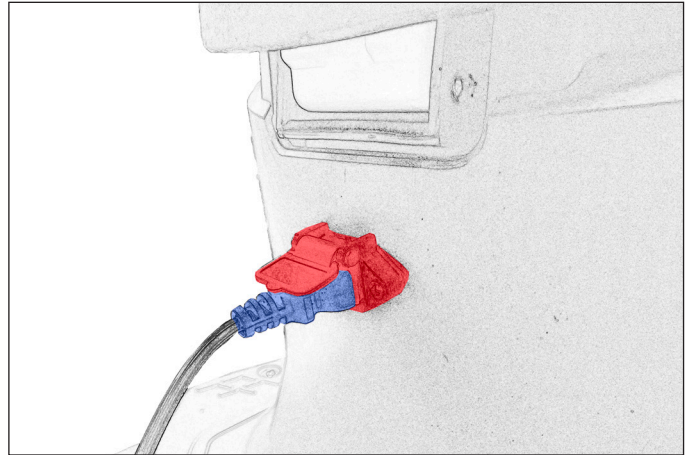

- Open the charging port lid and plug in the charger.

~110V

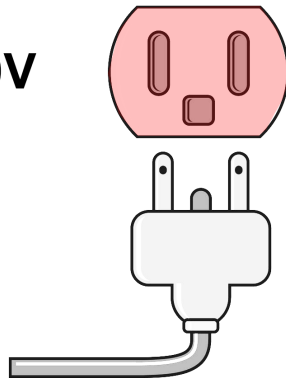

- Plug the charger into a regular 110V wall outlet.

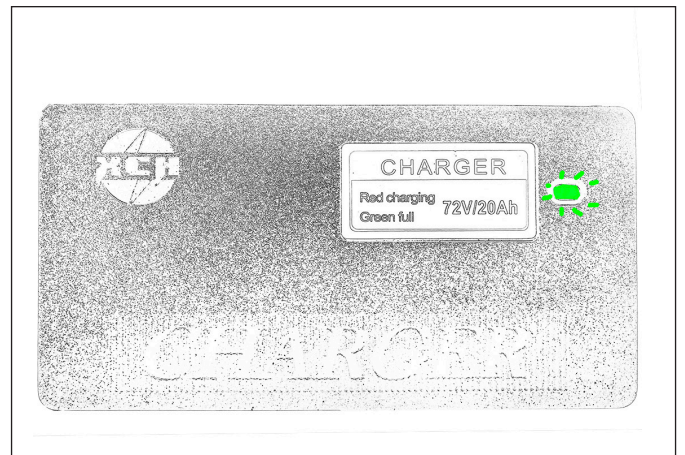

- Once fully charged*, unplug the charger from the wall outlet first and then unplug it from the bike.

*Please refer to Appendix 2 for more details of the indicators on chargers.

13. HOW TO RIDE THE BIKE

- Get the bike off the centre stand / side kickstand (refer to page 15).

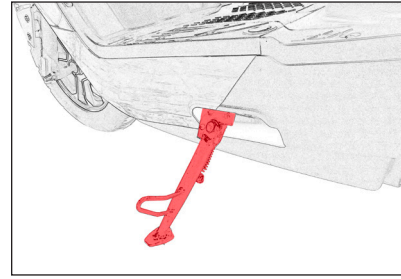

- Sit on the bike. Put on the helmet or any protective equipment required.

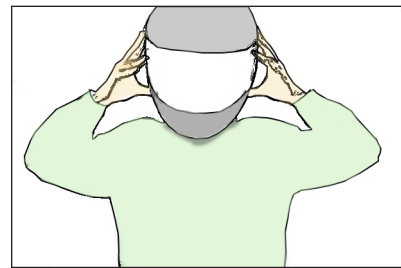

- With your feet still on the floor, turn the bike on (refer to page 19).

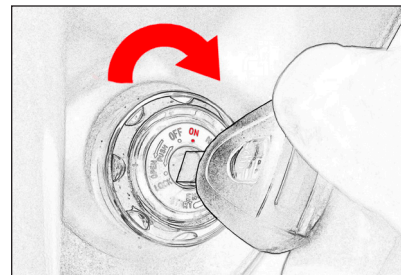

- When you are ready, turn the throttle and enjoy the ride.



14. SAFETY INSTRUCTIONS

To ensure the safety of you and others,

- Do not ride after you take medications which may affect your riding ability, drink alcohol, or when you are unwell.
- Please make sure you are familiar with your local bylaw regarding e-bikes.
- Check the road conditions and weather conditions, so as to actively avoid danger.
- Wear necessary protective equipment, such as an helmet, if required by local by-law.
- Perform a basic inspection of the bike before the ride:

1. Battery strength: make sure that you have enough charge for the trip.

2. Tire pressure: on the casing side of the tire you will find the minimum and maximum pressure that applies to the tire. Insufficient tire pressure will affect the performance of your bike.

3. Brakes: check and make sure both brakes are in good working condition.

4. Lights/signals: make sure that headlight, signal lights, tail light and brake light are working well. Make sure you have a working rear reflector/ tail light if you need to ride the bike at night.

15. MAINTENANCE

Regular maintenance is required to keep the bike in its best working conditions.

CLEAN

Please use clean water and neutral detergent to clean the bike. Use soft cloths or sponges to clean the surfaces. Please do not use metal brushes, sandpaper or any other abrasive material to avoid scratches or physical damage. Dry the bike with soft cloths. Please clean and grease the chain and sprockets.

Warning:

- Please turn off the circuit breaker and remove the battery (if applicable) before cleaning the bike.
- DO NOT power wash the e-bike.

STORAGE

In case of storage of more than one month, such as winter storage, Please charge the battery regularly (at least once a month) and turn off the circuit breaker. The bike, including the battery and charger, is suggested to be stored in clean, dry ventilated place. Please do not leave the battery outside under freezing temperature. Please avoid any corrosive material or heat source.

REGULAR INSPECTION

For **every 3000km** you travel or every **6 months**, a full inspection/tune-up is recommended based on the condition of the bike.

E-Bike Registration

E-Bike Registration

Once you have purchased an Emmo E-bike, you can register your vehicle with us to validate your warranty.

In order to register your e-bikes, please follow the steps listed below:

1. Fill out the following form:

Invoice Number: _____

Store Location: _____

Customer Name: _____

Address: _____

Phone Number: _____

E-mail: _____

Survey:

How did you find out about Emmo Inc.? (Please select the options that apply)

Returning Customer Family/Friend Passing by Store Kijiji
 TERA Google Yelp Other _____

2. Send the information listed above to our e-mail: info@emmo.ca

3. Wait for a confirmation e-mail from Emmo Inc.

APPENDIX 1

How to Charge a Lithium E-Bike

Most of the time, a lithium e-bike share the same look as a regular Gel Lead-Acid one. However, you will notice that the lithium battery is smaller in size and lighter in weight. The lithium charger is also different from ordinary Gel Lead-Acid chargers.

As shown in the follow picture, a typical lithium charger may consist of 2 parts:

1. Main body with a cable that connects to the charging port of the bike.
2. A separate cable that connects the regular 110V wall outlet with the charger.

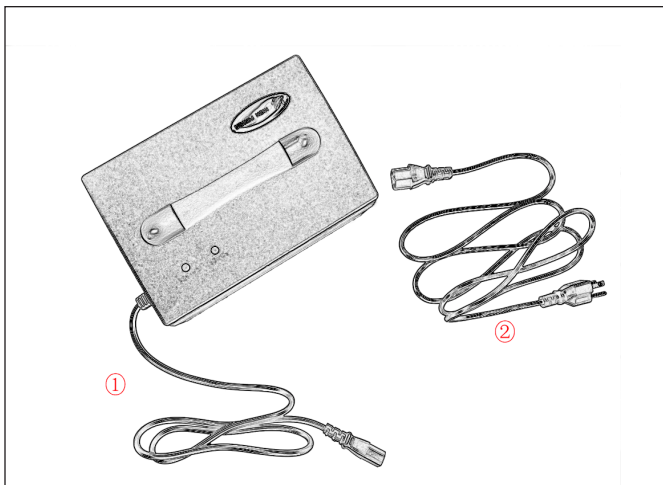

72V / 4.5A Lithium Charger

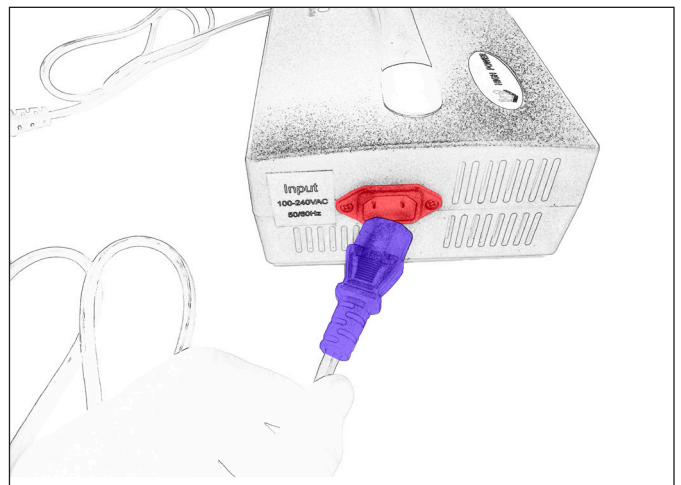

Plug the Separate Cable into the Charger

Before using the charger, you need to plug the individual cable into the charger. Same as Gel Lead-Acid versions, to charge the battery, plug the charger into the charging port of the bike. And then, plug the charger into a 110V outlet (refer to page 27).

APPENDIX 2

Charger Indicators

Usually, there is only one indicator on Gel Lead-Acid chargers. The indicator has only two colors - Red and Green. Red light means that the charger is charging the bike, while green light can show up when the battery is fully charged or when the charger is not connected to the bike properly. In other words, green light indicates the charger is not charging the battery/bike.

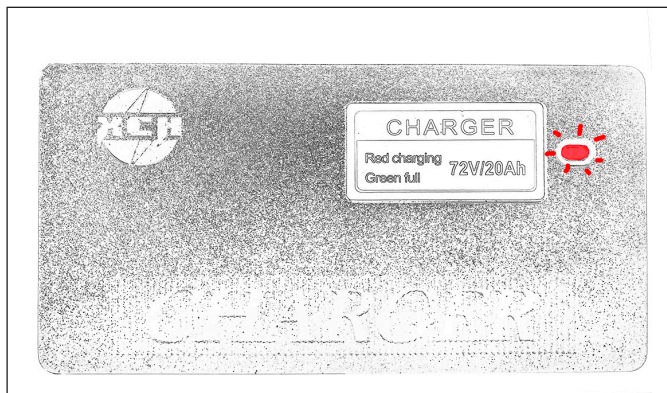

**Regular Charger with One Indicator
(Charging)**

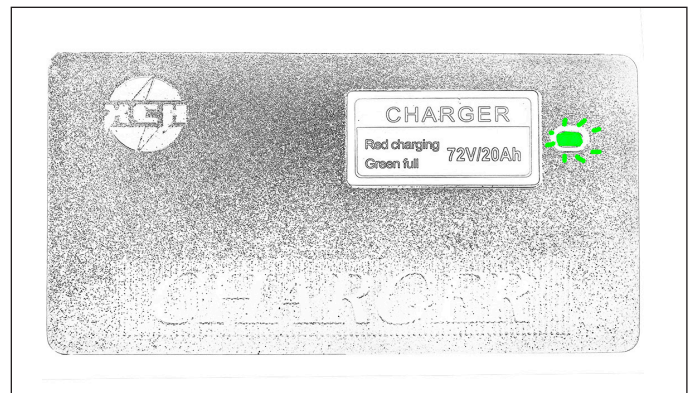

**Regular Charger with One Indicator
(Fully Charged)**

For some models, the lithium charger is similar to a Gel Lead-Acid one, with only one indicator and same indicating system.

However, for some lithium chargers, especially those with higher output, the charger is bigger in size and there are usually 2 indicators - the **POWER** indicator & the **CHARGE** indicator.

- *The **POWER** indicator has only one color- red. When the red light comes on, it means the charger is connected to the power outlet.*
- *The **CHARGE** indicator shows the working status of the charger with different colors of light. Red light means the charger is not connected to the bike / battery properly. Amber light means the charger is charging the battery, and green light indicates the battery is fully charged.*

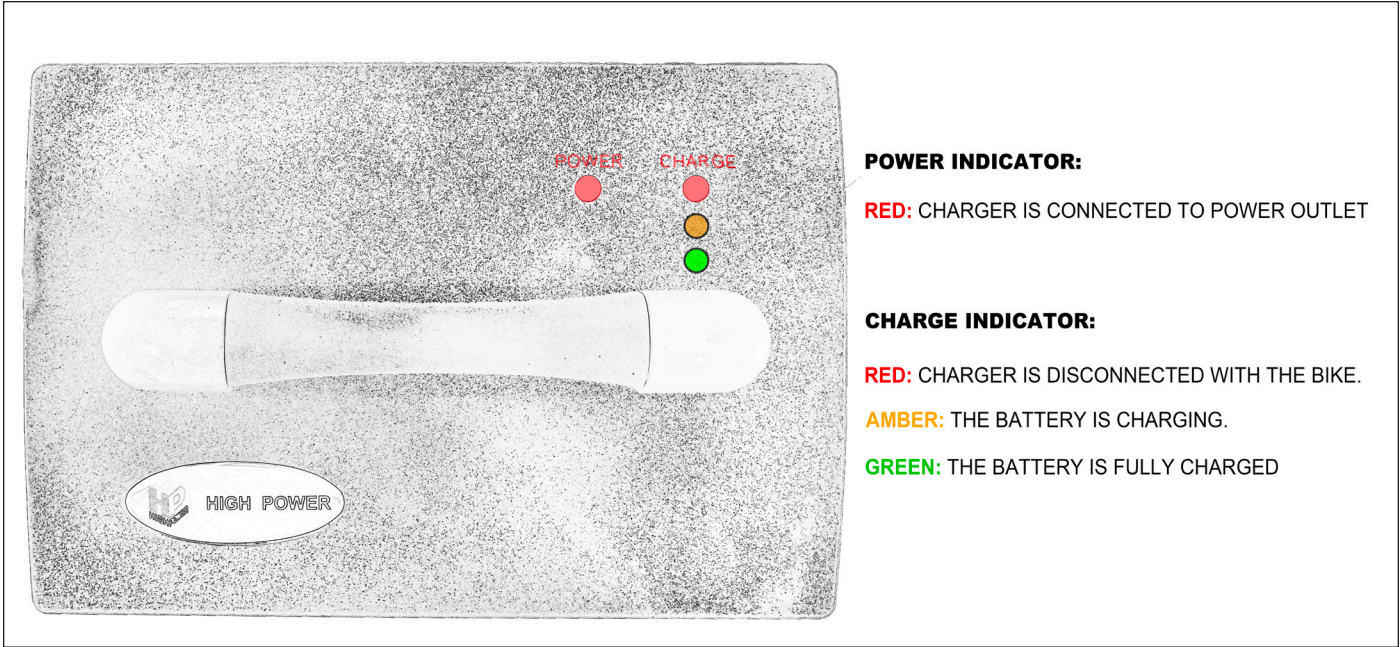

72V / 4.5A Lithium Charger Indicators