

EMMO VGO C

OWNER'S MANUAL



GREEN YOUR LIFE



Preface

An Important Message From EMMO

Thank you for choosing EMMO. Congratulations on your purchase of a new Vgo C.

This document is intended as a short introduction to your new e-bike. It contains essential safety, performance and service information. Please read and understand this manual fully before assembling and riding your bike. Be sure to watch the official Emmo Vgo C assembly video available at <https://emmo.ca/pages/e-bike-assembly-guide>.

Additional information about your bike can be found on our website at www.emmo.ca.

Be sure to check all hardware for correct torque during assembly.

Illustrations

Illustrations shown in this document may differ in detail from the exact configuration on your particular e-bike model. The illustrations are a general reference for instruction and description purposes only.

Service & Support

If you have questions after reading this manual and watching the assembly video, please feel free to contact us.

E-mail: service@emmo.ca

Toll Free: 1-888-217-1217

Find Emmo dealers near you: <https://emmo.ca/pages/locations>

Content

About This Manual	5
About EMMO	6
Rules and Regulations	7
Safety Disclaimer	10
Description	13
Schematic Diagram	13
Side View	13
Handlebar Attachments	14
Display	15
Operation Guide	15
Speedometer & Control	15
Control Function.....	17
Function Summary.....	18
Parameter Setting	24
Error Code	32

Adjusting the Seat Height.....	33
Adjusting the Saddle Position	34
Battery	35
Taillight.....	36
Battery Strength Indicator.....	37
Battery Power Switch	38
Battery Charging Port	39
Discharging port.....	40
Battery Lock.....	41
Battery Safety Precautions	43
Disposal.....	44
Storage & Maintenance	45
Charger	46
Charging Indicator.....	47
Charger Specification Label.....	48
Power Cord Socket	49
Power Cord	49

Charger Plug	50
Charging Precautions	51
Gear Shifter.....	52
Throttle	53
Adjusting the Suspension Fork	54
Cleaning / Lubricating the Chain.....	55
Tire Pressure	56
Serial Number.....	58
Riding Guide	65
Checking List Before Riding	65
Warranty Policy	66
E-Bike Registration	69
Contact Us.....	71

About This Manual

This document is intended as a short introduction to your new e-bike. It contains important safety, performance and service information. Read and understand it along with the information provided during the on-delivery instructions before using the product. Pay special attention to the safety messages as shown here, and keep the manual handy for future reference.



WARNING: Warning about a situation that can cause death, serious physical injury and or heavy material damage if one does not obey the safety instructions.



DANGER: Danger statement indicates a hazardous situation that, if not avoided, has a very high risk of death, serious injury, or property damage.



CAUTION: Caution statement indicates a hazardous situation that, if not avoided, could result in minor or moderate injury or property damage.



NOTICE: Notice is important information that can help you avoid bike/property damage or extend the life of parts and the bike.

About EMMO

Emmo is a proud Canadian company based in Toronto, Ontario. As the leading manufacturer of electric bikes, Emmo has provided over 500,000 people with environmentally-friendly transportation throughout North America. We believe that electric mobility for everyone is a big step in moving towards a zero-emission future.

Since 2009, Emmo has offered a large selection of electric mobility options for commuting and recreation. With our diversity of products, we create high-quality options to accommodate everyone's needs with an emphasis on reducing their carbon footprint. The past decade has proven that Emmo e-bikes are not only a sustainable method of transportation, but that they also push the limits of conventional bikes –to take you further, with less effort and more fun.

Driven by our vision of inspiring more people to lead a greener lifestyle, Emmo strives to give our riders' the best experience possible. Our in-house research and development spans two continents. Our e-bikes are designed in North America and undergo rigorous testing at our state-of-the-art facilities. Throughout this process, every facet of this complex supply chain is vigorously scrutinized to ensure the end product arrives in flawless condition at our four distribution centers in North America. We continue to be at the forefront of the e-bike industry. With over 100 retailers, Emmo is never too far away.

For over 13 years, our strong commitment to design and innovation has resulted in every Emmo product encompassing the latest technology. Our e-bikes exclusively use programmable sine-wave BLDC controllers, allowing higher performance, longer range and enhanced reliability in all conditions. Backed by our comprehensive warranty, we ensure riders are confident in the purchase of their Emmo.

Emmo believes that a greener future is not only possible, it's necessary, and we want to do our part to build greener communities by making e-bikes more accessible.

Rules and Regulations

According to **Canada's Motor Vehicle Safety Regulations (MVSR)**. A qualified e-bike (defined as Power Assist Bicycle) must meet the following requirements:

- The e-bike must have operational pedals
- Upper wattage limit for the motor is 500W
- Maximum speed of an e-bike is 32km/h.

Other requirements include a permanently affixed compliance label from the manufacturer stating that the vehicle is a power-assisted bicycle under statutory requirements in force at the time of manufacture. Currently, there is no license, no insurance, and no vehicle registration required to operate a qualified e-bike according to federal legislation. E-Bike riders share the same rights and responsibilities as other road users.

However, provinces and local municipalities have the power to restrict the use of e-bikes. Most provinces require the rider to wear a helmet. Some provinces have special requirements with regard to the age limit to operate an e-bike, the type of helmet required, even the number of wheels and wheel size. In Ontario, typically, e-bikes are generally treated the same as regular bicycles. According to the Ministry of Transportation of Ontario (MTO), the age limit to operate an e-bike is 16 years old and above; the maximum weight of the bike is 120 kilograms (265 pounds); the bike must have a brake distance of less than 9 meters; Any modifications made to the bike's motor to create speeds greater than 32km/h are prohibited.

The rules and regulations are subject to changes in different provinces and municipalities. Please check your municipal bylaw and see where you stand.

Rules and Regulations

Useful links:

E-Bike Regulations in Ontario:

<https://www.ontario.ca/page/riding-e-bike>

E-Bike Regulations in British Columbia:

https://www.bclaws.gov.bc.ca/civix/document/id/complete/statreg/151_2002

E-Bike Regulations in Alberta:

<http://www.transportation.alberta.ca/content/doctype45/production/mopedpowerbikes.pdf>

E-Bike Regulations in Manitoba:

<https://web2.gov.mb.ca/laws/statutes/ccsm/h060e.php>

E-Bike Regulations in Saskatchewan:

https://www.sgi.sk.ca/motorcycle/-/knowledge_base/motorcycle-handbook/power-assisted-bicycles1

E-Bike Regulations in Quebec:

<https://saaq.gouv.qc.ca/en/road-safety/modes-transportation/electric-bike>

E-Bike Regulations in New Brunswick:

https://www2.gnb.ca/content/gnb/en/services/services_renderer.200814.Motor_Vehicle_Registration.html

E-Bike Regulations in Nova Scotia:

<https://novascotia.ca/just/regulations/regs/mv18786.htm>

E-Bike Regulations in Prince Edward Island:

<https://www.princeedwardisland.ca/en/information/transportation-and-infrastructure/power-assisted-bicycles>

Know and obey all relevant local laws

It is your responsibility to research and understand relevant laws where you ride your bike. Such laws may cover required helmets and safety gear, required lights and reflectors, required hand signals, where you can legally ride a bike (bikes and ebikes may have different restrictions), how fast you can go, what (if any) cargo or passengers you can carry, rider age, and more. Before using public transportation—buses, trains, etc.—to transport your e-bike, check with the relevant transportation authority for any rules governing weight limits, tire widths, lithium-ion batteries, or any other rules that might pertain to e-bikes. When you ride on the road, assume you must, at minimum, follow all of the rules that cars must follow. For additional information regarding traffic and vehicle laws, contact the road traffic authority in your area.

Safety Disclaimer

This manual contains important safety, performance and service information. Read and understand it along with the information provided during the on-delivery instructions before using the product, and keep it for reference. Ensure that you comprehend all instructions and safety notes/ warnings.



WARNING: Ensure the bike fits you properly before use. You might lose control if the bike is too small or too big for you.

By choosing to ride an electric bicycle you assume the responsibility for the risk of riding an e-bike. The rider is responsible to know and practice the rules of safe and responsible riding, as well as proper use and maintenance of the bicycle.



WARNING: Riders must have the physical condition, reaction time and mental capability to ride and manage traffic, road conditions, and sudden situations. Riders should also familiarize themselves on local bylaws regarding riding an e-bike.

If you have an impairment, hearing impairment, physical impairment, cognitive language impairment, or a seizure disorder, consult your physician before riding any bicycle.



WARNING: Failure to confirm proper installation, compatibility, proper operation or maintenance of any component or accessory can result in serious injury or death. Make sure that correct setup, tightening and torquing to recommended torque values have been completed on your bike.



CAUTION: Before the first ride, familiarize yourself with all the bicycle features. Practice and become proficient

at applying the brakes, using the throttle in a controlled setting before riding in more risky conditions. If you plan to ride at night, familiarize yourself with the lights and signals.



WARNING: Please make sure the bike works properly and safely before each ride or (inspect key components, including but not limited to the brakes, brake sensors, throttle). Make sure all the hardware, such as the handle bar, hand grips, seat, pedals are secured in place. Have your bike inspected by a licensed mechanic on a regular basis depending on the condition of the bike.



DANGER: DO NOT use this product with standard bike trailers, stands, vehicle racks, or accessories that have not been tested for safety and compatibility and verified as safe and compatible with the bike by EMMO. Contact us if you have any question or concern.



WARNING: E-Bikes and e-bike parts have strength and integrity limitations. Extreme riding should not be performed or you will risk damaging the components or becoming seriously injured or killed. This includes but not limited to jumps, stunts, or any riding that exceeds your capabilities.



WARNING:

- Keep the battery away from children and pets.
- Keep the battery & charger away from water and open fire.
- **DO NOT** drop or subject the battery & charger to any big shocks.
- Charge the battery only with the charger that was supplied with the e-bike or supplied by an official EMMO dealer.
- **DO NOT** use the battery & charger for other purposes.

- Never connect the battery's terminals with each other.
- **DO NOT** cover the battery & charger or place objects on top of it during charging.
- **DO NOT** leave the battery & charger unattended while charging.
- Disconnect the charger and the battery immediately if you notice a strange smell or smoke.
- In the unlikely case that the battery is on fire: NEVER try to put the fire out with water. Cover the fire with large amounts of sand and call emergency services immediately.

In no event shall EMMO be responsible for any direct, indirect or consequential damages, including without limitation, personal injury, property damage, or economic losses, whether based on contract, warranty, negligence, or product liability.

Description

1. Schematic Diagram

a. Side View

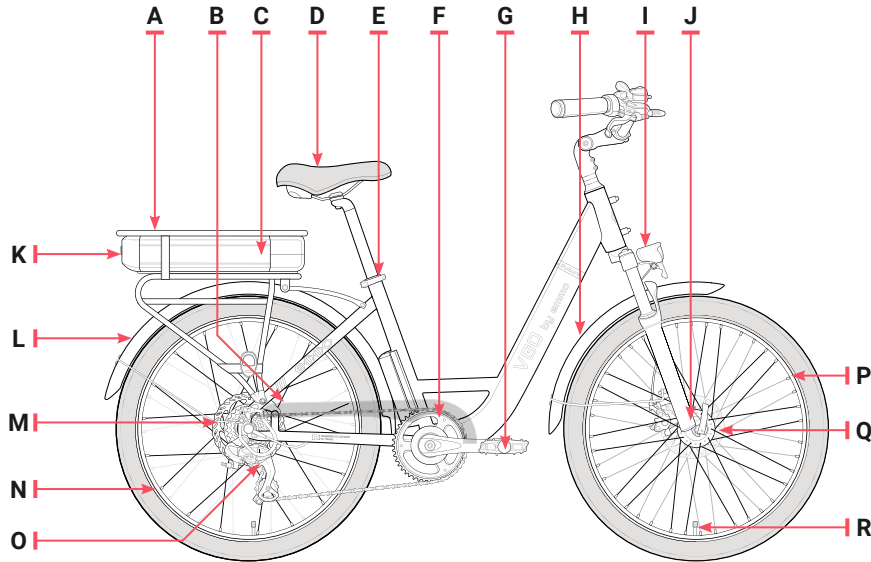

A	Rear Rack
B	Chain
C	Battery
D	Seat Cushion
E	Seat Clip
F	Pedal Crank
G	Pedal
H	Front Fender
I	LED Headlight
J	Front Adjustable Shock
K	Taillight
L	Rear Fender
M	Rear Brake Disk
N	Rear Rim With Motor
O	Derailleur
P	Front Rim
Q	Front Brake Disk
R	Valve

Description

1. Schematic Diagram

b. Handlebar Attachments

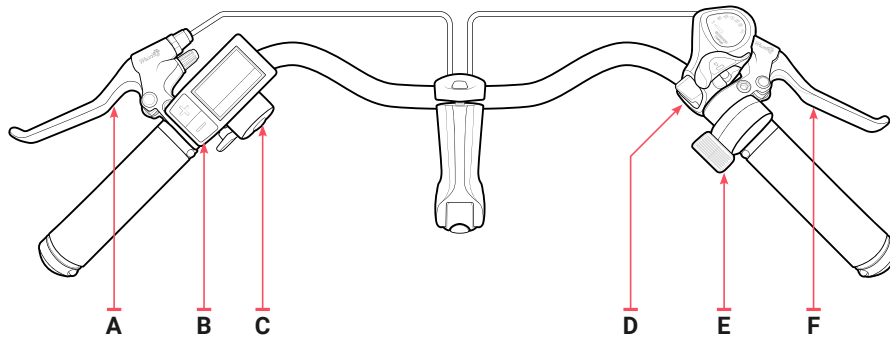

A	Left Brake Lever
B	Speedometer
C	Bell
D	Gear Shifter
E	Throttle
f	Right Brake Lever

Operation Guide

1. Speedometer & Control



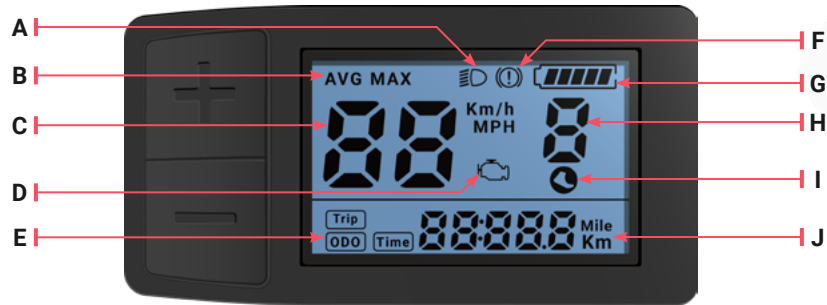





a. Display



Operation Guide

1. Speedometer & Control

a. Display

A		Headlight Indicator	The headlight indicator lights up when the headlights are turned on and remains illuminated until they are turned off.
B		Speed Mode Indicator	Average speed, Max Speed, Real-Time Speed.
C		Current Speed	Indicates the real-time speed of the bike.
D		Motor Error Indicator	Illuminates when there is an error detected in the motor.
E		Mileage Mode	Mode of Odometer, Trip Distance, and Riding Time.
F		Brake Sensor Failure	Brake is applied (brake sensor is activated)/Brake sensor failure.
G		Battery Indicator	Indicates the current battery strength.
H		PAS Lever	Displays the current level of pedal-assist assistance, with corresponding indicator lights that illuminate when pedal-assist assistance is engaged.
I		Mileage	Displays detailed numerical values for Odometer, Trip Distance, and Riding Time.

Operation Guide

1. Speedometer & Control

b. Control Function

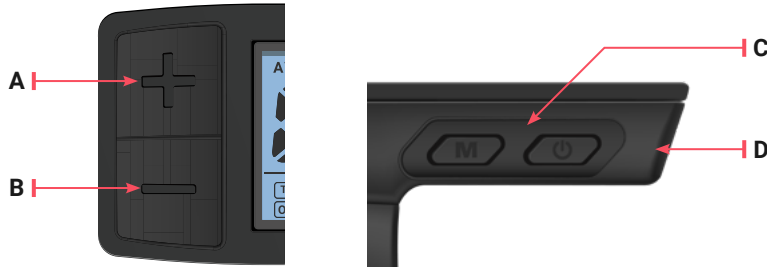

A	Up Button
B	Down Button
C	Mode Button
D	Power Button

Power On/Off

Hold the **Power** button for 1 second to toggle the display on or off. The display will automatically shut down after X minutes of inactivity or no riding (X can be set between 0-9 minutes). The duration for auto power-off can be customized in the settings.

Operation Guide

1. Speedometer & Control

c. Function Summary

Adjusting the Assist Level

To adjust the assist level, simply press the **Up/Down** button. The top assist level is 9, with 0 representing the neutral level. Customize the number of levels according to your requirements. When you activate the assist, the indicator light will illuminate, and the light will turn off if the level is set to 0.



LEVEL 0



LEVEL 1



LEVEL 9

Operation Guide

1. Speedometer & Control

c. Function Summary

How to Change the Speed Mode

After starting, the default setting displays the current speed. To change the speed type, press the **Power** button. You can switch to the maximum speed display by pressing the **Power** button once, and pressing the Power button again will switch to the average speed display.



CURRENT SPEED



MAX SPEED



AVG SPEED

! NOTICE: If there is no operation for 5 seconds, the display will automatically return to the current speed.

Operation Guide

1. Speedometer & Control

c. Function Summary

How to Change the Mileage Mode

Upon startup, the default setting displays the distance. To change the displayed information, simply press the **Power** button. Pressing the **Power** button once will switch to the Odometer display, and pressing the **Power** button again will switch to the Trip time display.



TRIP DISTANCE



ODOMETER DISTANCE



TRIP TIME

! **NOTICE:** If there is no operation for 5 seconds, the display will automatically return to the current speed.

Operation Guide

1. Speedometer & Control

c. Function Summary

Turn ON/OFF Headlight and Taillight

To turn on the headlight and taillight, hold the **Up** button for 1 second. Hold the **Up** button for 1 second again to turn off the lights.



HEADLIGHT OFF



HEADLIGHT ON

! **NOTICE:** When the battery voltage is low, the motor will not function. However, the display can still keep the headlight on for a while when the E-bike is in use.

Operation Guide

1. Speedometer & Control

c. Function Summary

Walking Mode

To enter walking mode, simply hold the **Down** button. In this mode, the bike will automatically run at approximately 6 km/h. To exit walking mode, release the button.



WALKING MODE

! **NOTICE:** This feature needs to be supported by the controller.

Operation Guide

1. Speedometer & Control

c. Function Summary

Battery Strength Indication

The 5 bars represent the battery strength. It is suggested that you charge the battery when it is lower than 20%-30%(1-2 bars). If the battery level is extremely low, the battery frame will flash. You must charge the battery immediately to prevent possible damage to the battery.

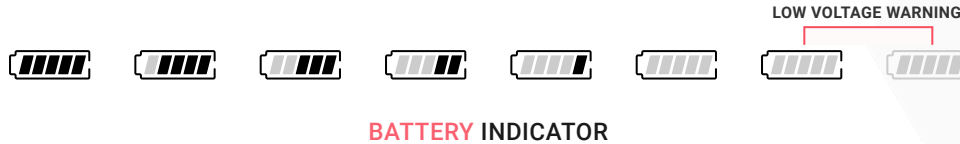

Data Reset

Hold **UP** and **DOWN** buttons together for 1 second to reset temporary data including Max Speed/ AVG Speed / Trip Distance / Trip Time. Once temporary data is reset, it cannot be recovered.

! **NOTICE:** Simply turning the bike off will not reset the temporary data.

Operation Guide

1. Speedometer & Control

d. Parameter Setting

To access the setting menu, press and hold the **Mode** button for at least 2 seconds. Use the **Up/Down** buttons to change the parameter settings, and press the **Mode** button to switch to the next parameter. Remember to hold the **Mode** button for at least 2 seconds each time.

The order of the parameters is as follows:

- | | |
|-------------------------|-------------------------------|
| A. Unit km/mile | E. Password |
| B. Backlight Brightness | F. Magnetic Pole Setting |
| C. Auto-off time | G. Pedal Assist Range Setting |
| D. Wheel Diameter | |

NOTICE:

- The display will automatically quit the menu if there is no operation for 10 seconds.
- For safety reasons, the display cannot access the MENU while riding.
- The display will exit the MENU once riding is initiated.

Operation Guide

1. Speedometer & Control

d. Parameter Setting

A. Unit (Kilometer/Mile)

Press the **Up/Down** button to switch between Metric and Imperial units.

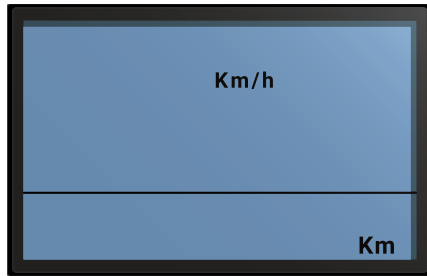

UNIT KILOMETER

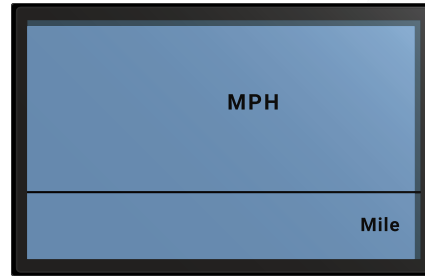

UNIT MILE

Operation Guide

1. Speedometer & Control

d. Parameter Setting

B. Backlight Brightness

Press the Up/Down button to adjust the brightness of the backlight. The range is from 1 (the dimmest) to 5 (the brightest).



SYMBOL (b1)

Operation Guide

1. Speedometer & Control

d. Parameter Setting

C. Auto Off Time

Press the **UP/DOWN** button to adjust the auto power off time, ranging from 0 to 15 minutes. Each number represents the time (in minutes) before the device automatically shuts down. Setting it to "OFF" disables the auto off function. The default setting is 5 minutes.



SYMBOL (OF)

Operation Guide

1. Speedometer & Control

d. Parameter Setting

D. Wheel Diameter

Press the **Up/Down** buttons to adjust the wheel size setting. The optional wheel diameter ranges from 6 to 34 inches.



SYMBOL (Hd)

Operation Guide

1. Speedometer & Control

d. Parameter Setting

E. Enter the Password

Press the **Mode** button to enter the advanced setting menu. To access this menu, use the default password 1919.



SYMBOL (Pd)

Operation Guide

1. Speedometer & Control

d. Parameter Setting

F. Magnetic Pole Adjustment

Inside the motor, there are magnetic poles. To change the pole, simply press the **Up/Down** button.

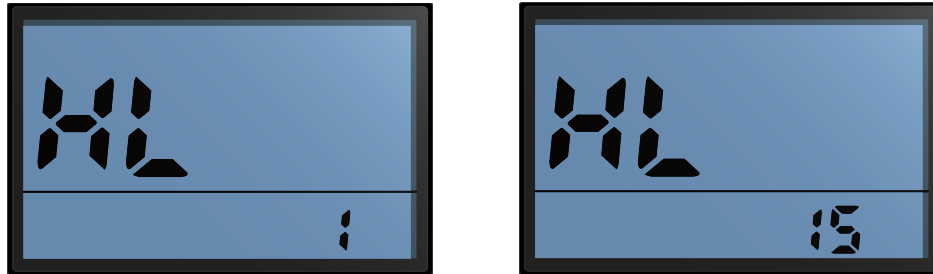

SYMBOL (HL)

! **NOTICE:** If you have any questions, please contact your local dealer.

Operation Guide

1. Speedometer & Control

d. Parameter Setting

G. Pedal-Assist Level

To customize the assist levels, use the **Up/Down** buttons to change the value. The available options are UBE, 3, 5, and 9.



SYMBOL (PA)

Operation Guide

1. Speedometer & Control

e. Error Code

The speedometer can indicate warning messages by flashing the error icon and displaying the corresponding error code. The error codes range from 01 E to 0nE. Refer to the table below for the definitions associated with each error code.

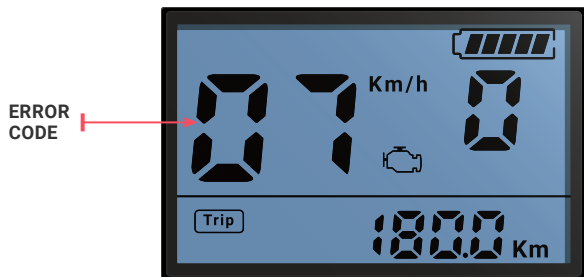

Error Code	Error Description
04	Throttle on high position
06	Low voltage protection
07	High voltage protection
08	Motor's hall sensor error
09	Phase line of motor error
10	Controller over temperature
11	Motor over temperature
12	Current sensor error
13	Battery's temperature sensor error
14	Motor's temperature sensor error
21	Speed sensor error
22	BMS communication error
30	Communication error

Operation Guide

2. Adjusting the Seat Height

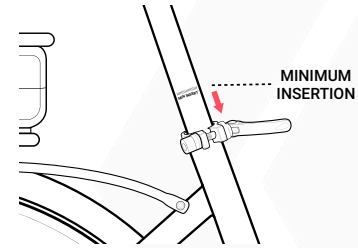
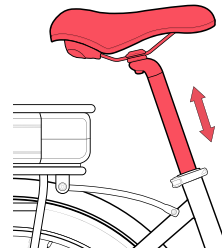
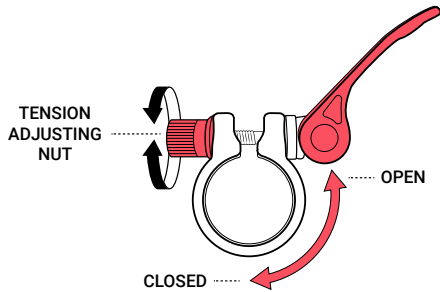

- Unlock the seat clamp, loosen the tension adjusting nut.
- Adjust the seat height to your preferred position and lock the clamp.
- Align the clamp opening with the notch in the seat tube and close the clamp lever fully.
- Closing the clamp should require enough pressure that it leaves an imprint in your hand.



WARNING: There is a **MINIMUM INSERT** marker on the seat post. You must not raise the seat to a higher position than that. Raising the seat post higher will result in injury or damage to property/e-bike.

Operation Guide

3. Adjusting the Saddle Position

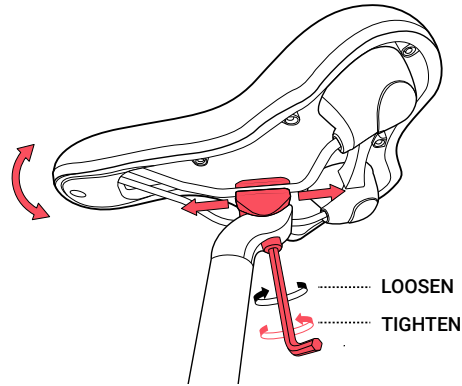

- Loosen the bolt at the bottom.
- Adjust the saddle tilt by pressing down on the front or rear of the saddle.
- Tighten the bolt to secure the saddle.

Operation Guide

4. Battery



A	Taillight
B	Battery Strength Indicator
C	Battery Switch
D	Battery Charging Port
E	Discharging Port

Operation Guide

4. Battery

a. Taillight

The taillight is located on the battery. When you turn on the e-bike's headlight, the taillight will illuminate simultaneously, providing enhanced visibility and safety during operation.

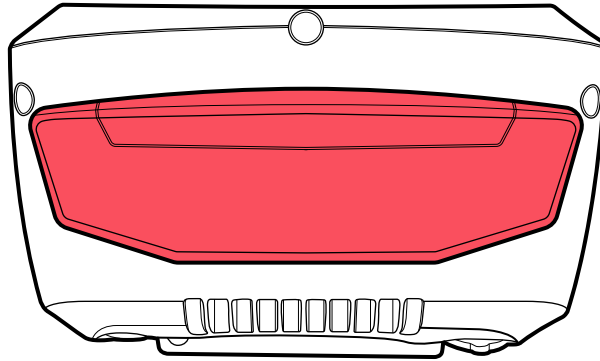

Operation Guide

4. Battery

b. Battery Strength Indicator

Hold the **button** to see the current battery strength.

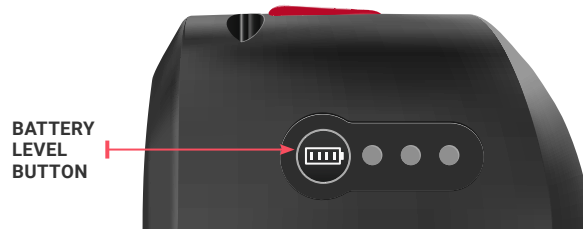

Operation Guide

4. Battery

c. Battery Power Switch

The battery power switch is used to control the power supply in the electric bicycle. It allows you to turn the e-bike's power on or off as needed.



Operation Guide

4. Battery

d. Battery Charging Port

The charging port of the battery is located at the bottom, and you can find it by opening the rubber cover.

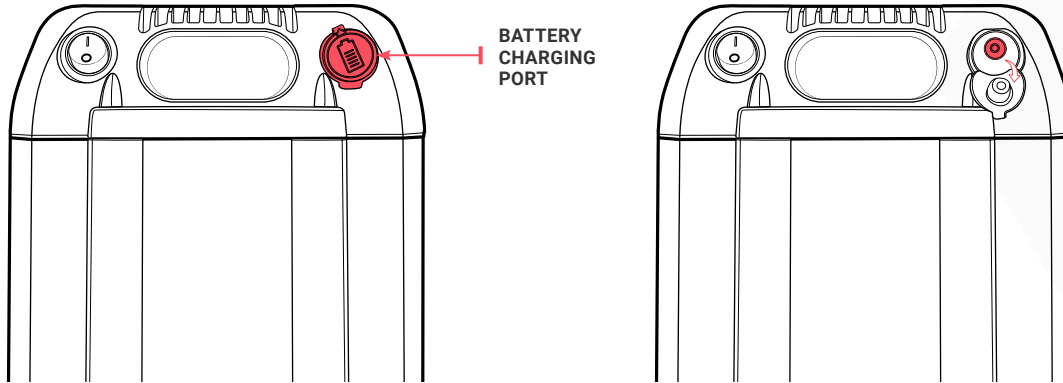

Operation Guide

4. Battery

e. Discharging port

The discharging port is connected to the bike.

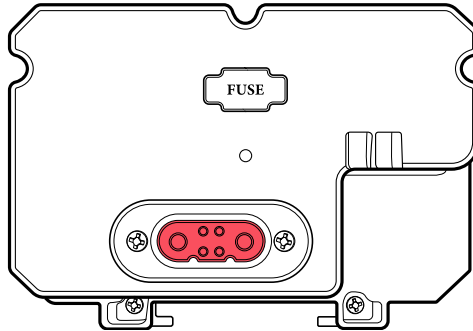

Operation Guide

4. Battery

f. Battery Lock

How to Remove the Battery

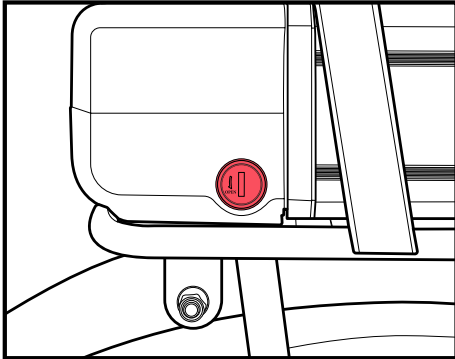

I. The Battery Lock is positioned on the rear rack of the electric bicycle.

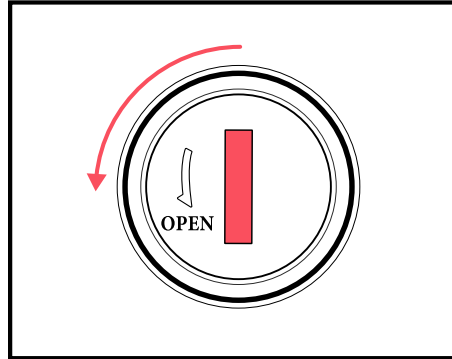

II. Insert the key and turn it anticlockwise to unlock the battery lock.

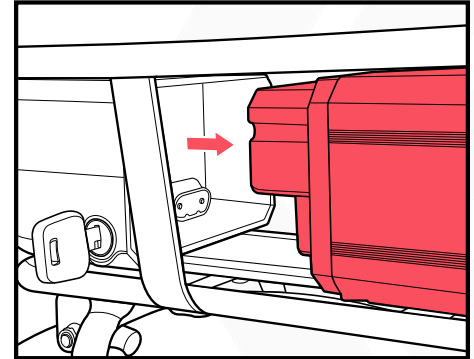

III. Slide the battery out along the rail.

Operation Guide

4. Battery

f. Battery Lock

How to Insert the Battery

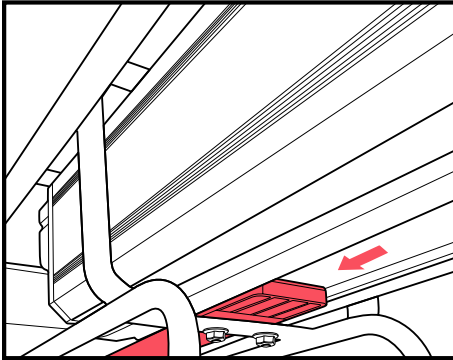

I. Slide the battery in along the rail.

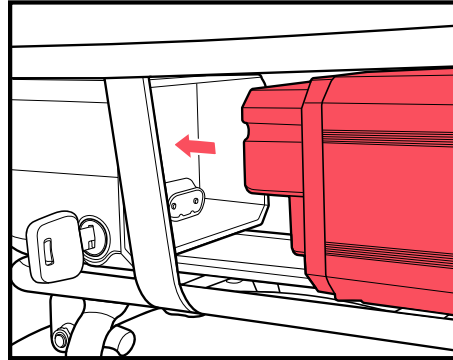

II. Fully insert the battery into the controller box until you hear a clicking sound.

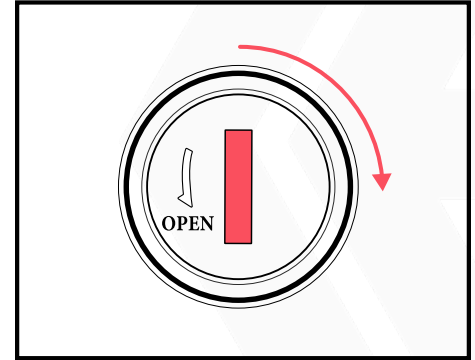

III. Insert the key and turn it clockwise to lock the battery lock

Operation Guide

4. Battery

g. Battery Safety Precautions

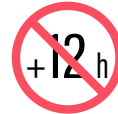

- Be sure to use the original/compatible battery (approved by EMMO). Using batteries from other brands may lead to severe accidents.
- Inspect the battery for any damage, leaking, overheating or smoking.
- Always charge between **0°C to 45°C**, charging outside of this range may cause permanent damage to battery.
- **DO NOT** lift the battery by its connectors or cables.
- **DO NOT** charge the battery for over 12 hours.
- **DO NOT** subject the battery to impact.
- **DO NOT** subject the battery to water.
- **DO NOT** subject the battery to heat or open fire.
- **DO NOT** open the battery pack by yourself. If you need any assistance, please contact your EMMO dealer.

Operation Guide

4. Battery

h. Disposal



This product contains lithium batteries which must be disposed or recycled in an environmentally safe manner. Do not dispose of the batteries in your household trash. Do not dispose of the batteries in a fire, this could cause the batteries to leak or explode. The incineration, disposal in landfill and or placing lithium batteries with household trash is prohibited by law in most areas.

NOTICE:

- Used batteries must be treated as hazardous waste.
- Batteries must be disposed of in accordance with the the regulations set forth by your local government/organizations.
- In case of uncertainty, please contact EMMO customer service department at service@emmo.ca

Operation Guide

4. Battery

i. Storage & Maintenance

- For storage, please disconnect the battery from the bike and charge the battery on a regular basis (at least once a month).
- Battery packs and chargers need to be stored in a clean, dry, well ventilated place, avoid contact with corrosive material, and keep them away from heat and fire.
- Battery storage conditions: temperature:-20 - 35°C , humidity ≤ 65%RH.

Operation Guide

5. Charger

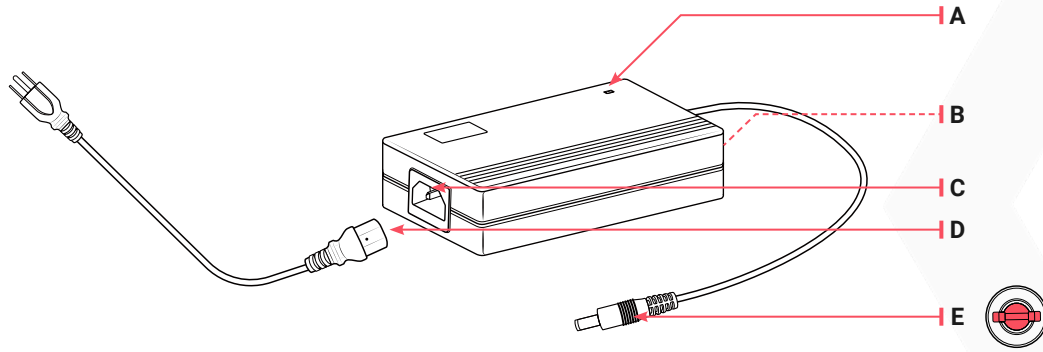

A	Charging Indicator
B	Charger Specification Label
C	Power Cord Socket
D	Power Cord
E	Charging Plug

Operation Guide

4. Charger

a. Charging Indicator

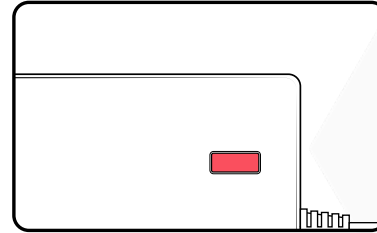
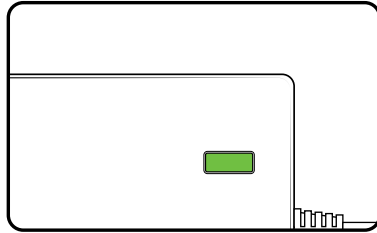

Charging Indicator Explanation:

- During normal charging, red light stays on.
- The indicator will turn green when the battery is fully charged.

! **NOTICE:** If the charger gets warm during regular use, this is normal and is no cause for concern.

Operation Guide

4. Charger

b. Charger Specification Label

Battery Charger

MODEL : SSLC180V48M
INPUT: 120V~3.0A 60Hz
OUTPUT: 48V ---3.0A

⚠ CAUTION: -indoor use only,
Charge only 48V Battery type rechargeable
batteries. Other types of batteries may burst
causing personal injury and damage.
Backfeed protection.

⚠ ATTENTION
- l'intérieur seulement, la charge que
48V batterie type de pi les rechargeables.
d'autres types de pi les peut éclater et
causer des dommages corporels. backfeed
protection.

● GREEN: CHARGE FULL OR DISCONNECT
● RED: CHARGING



Operation Guide

4. Charger

c. Power Cord Socket

d. Power Cord

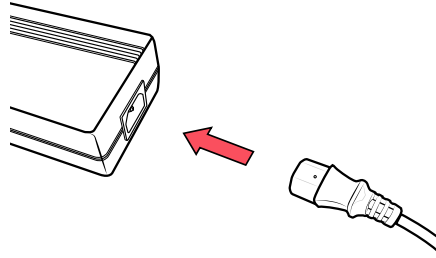

Connecting the charger:

- Plug **d** of the power cable into the device socket **c** on the charger.



WARNING: You **MUST NOT** plug the power cord directly to the bike/battery. High voltage may damage the bike/battery and cause severe injury.

Operation Guide

4. Charger

e. Charger Plug

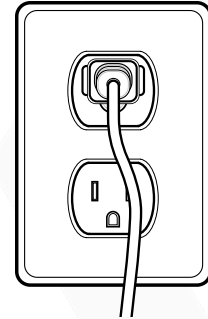
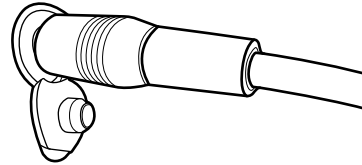
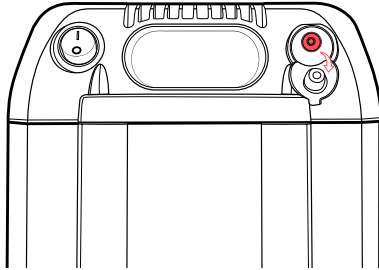

How to charge:

- The charging port is located at the tail end of the battery. (Refer to "[Battery Charge Port](#)" on Page 39.)
- Open the rubber cover of the charging port and then insert the charger.
- Plug the charger into a regular 110V wall outlet.

Operation Guide

4. Charger

f. Charging Precautions



WARNING:

- You must use the compatible charger (approved by EMMO) to charge the battery.
- **DO NOT** submerge or allow the charger to become submerged in water or any liquid.
- **DO NOT** use the charger if the cord becomes frayed, has exposed solution or wires or shows any damage.
- **DO NOT** use the charger if the plastic enclosure or the charging connector is broken, cracked or shows any significant damage.
- If the charger/battery becomes unreasonably hot, please disconnect the charger from the power outlet and contact your EMMO dealer immediately.
- After the charging is completed, please disconnect the charger from the power outlet first.
- Leave the battery and charger out of the reach of children.
- Charge the battery in a dry, well-ventilated space. **DO NOT** charge the battery in the rain /snow.

Operation Guide

6. Gear Shifter

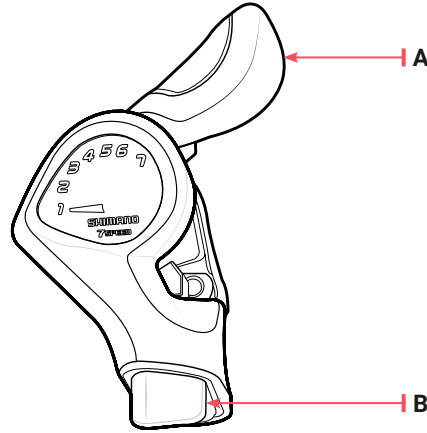

A	Pushing the upper lever to raise the gear (smaller numbers).
B	Pushing the button to lower the gear (bigger numbers).

Operation Guide

7. Throttle

Gently pushing the throttle lever downwards to accelerate.

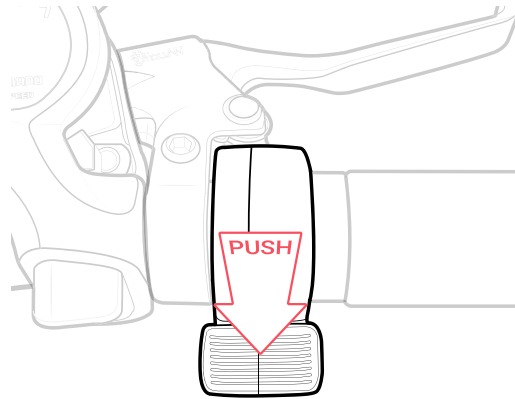

! **WARNING:** DO NOT press the throttle if you are not ready to ride.

Operation Guide

8. Adjusting the Suspension Fork

The suspension fork can move up and down to cushion bumps, which can make riding on a rough road or trail smoother and more comfortable.

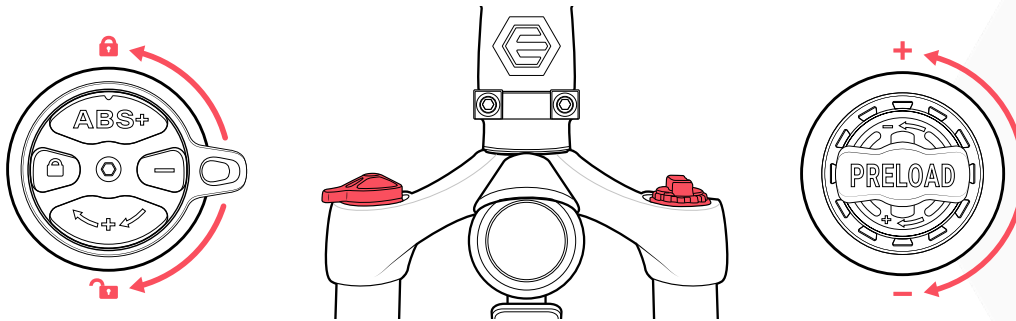

- **Locking the fork** creates a rigid fork fork, which can yield higher efficiency while pedaling and a more predictable ride depending on conditions such as terrain and cargo load.
- **Adjusting the preload** dial makes the fork softer, feel smoother, and more comfortable when riding on a rough road or trail surface.

Operation Guide

9. Cleaning / Lubricating the Chain

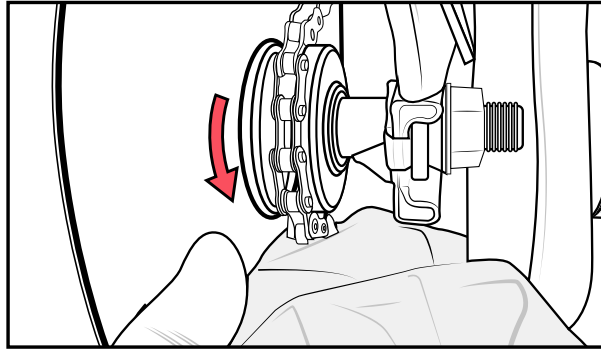

How to Clean the Chain:

- Put the bike on a service stand or lean the bike on the kick/side stand. Make sure the back wheel is off the ground.
- Locate the chain on the right side of the bike, near the rear wheel hub.
- Hold a clean cloth to the chain (as shown).
- Turn the pedal to clean the chain.
- Apply new bicycle chain oil to the sprocket and chain.

Operation Guide

10. Tire Pressure

It is recommended to check the tire pressure on a regular basis to keep things at their best working conditions.

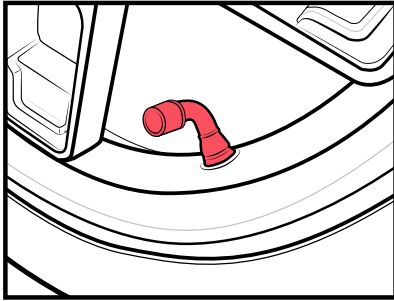

I. Locate the valve on the rim.

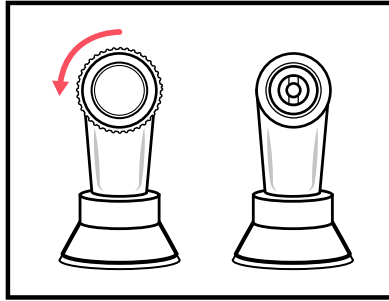

II. Remove the valve cap.

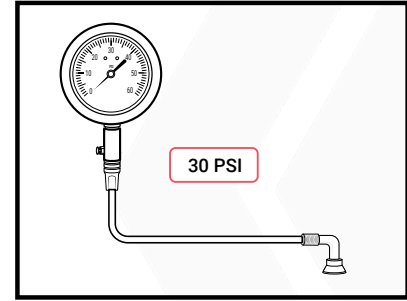

III. Use an air pump with gauge to adjust the tire pressure to 30 PSI.

Tire pressure affects the following:

- Service life of the tires and other components of the bike.
- Riding safety.

Operation Guide

10. Tire Pressure

- Riding comfort
- Travel distance



WARNING:

- You **MUST** inflate the tire to the recommended tire pressure before the first ride. Failure to do so may damage your bike and void your warranty.
- **DO NOT** over-inflate, as this could damage the tire or wheel. (The recommended tire pressure range is marked on both tires by the manufacturers.)

Operation Guide

11. Serial Number

a. Frame Number

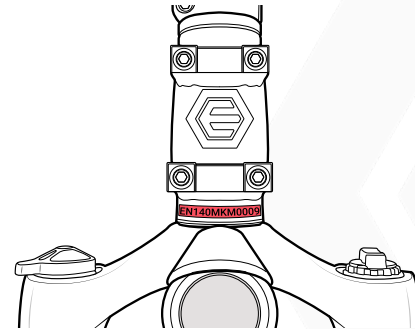
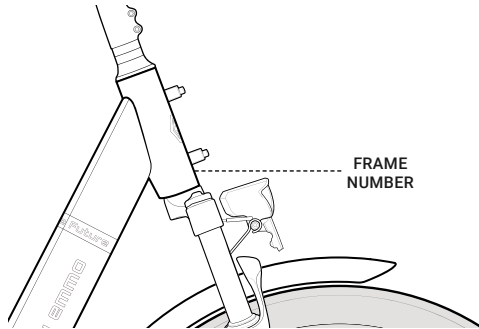

Find the Frame Number:

- The frame number is engraved on the neck of the frame.

Operation Guide

12. Serial Number

b. Motor Number

Located on the motor.

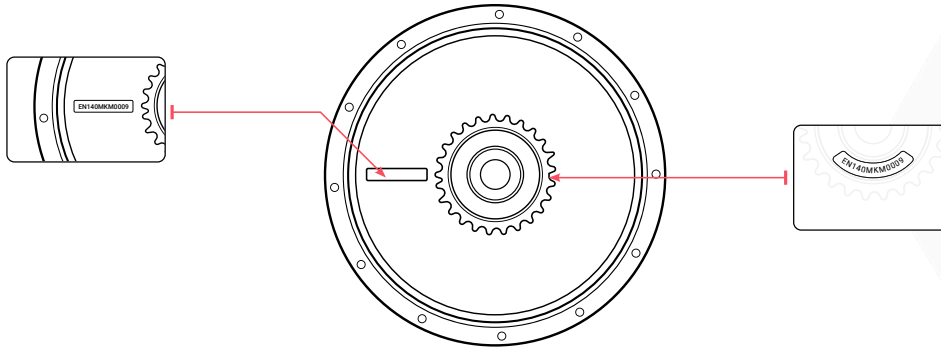

The motor number could be located at the following locations:

- **Location 1:** On the motor cover plate.
- **Location 2:** Behind the sprocket on the motor.

Troubleshooting

Potential Issues/Errors	Most Common Way To Solve Issue
Battery not fully seated in tray	Install battery correctly
Insufficient battery power	Need to recharge/test.
Faulty connections	Reinstalling or testing battery/wiring.
Improper turn on sequence	Clean and reconnect connectors
Brakes are applied	Try restarting the ebike.
Electrical cable unplugged	Repair or replace
Walk mode stopped	Ensure nothing is keeping any button(s) other than the walk mode button pressed on the UI Remote (on some models)
Control button(s) held	Ensure nothing is keeping any button(s) pressed on the UI Control (on some models)
Battery non-functional	Replace battery
Damaged or disconnected pedal assist sensor	Replace or reconnect pedal assist sensor
Loose wiring	Repair and or reconnect
Loose or damaged throttle	Tighten or replace
Loose or damaged motor plug wire	Secure or replace motor plug wire
Damaged motor	Repair or replace

Troubleshooting

Low or faulty battery	Check connection, charge or replace battery
Low tire pressure	Adjust tire pressure
Climbing too many hills, strong headwind, braking, and/or excessive load	Adjust your route or assist with pedals
Brakes rubbing	Adjust the brakes
Battery discharged for long period of time without regular charges, battery is aged, damaged, or unbalanced	If range decline persists; contact local dealer
Insufficient battery power	Charge or replace battery
Loose or damaged motor wiring	Reconnect or replace motor
Loose or damaged wheel spokes or rim	Tighten, repair, or replace
Battery damaged	Replace
Charger not well connected	Adjust the connections
Charger damaged	Replace
Wiring damaged	Repair or replace
Blown charger fuse	Replace charger fuse

! **NOTICE:** If you have any questions, please contact your local dealer.

Recommended Torque Values

Area		Tool	Rec. torque
Handlebar	Stem clamp bolts	5 mm Allen	10 Nm
	Stem faceplate bolts	5 mm Allen	6 Nm
	Stem angle adjustment bolt (side)	5 mm Allen	12 Nm
	Stem angle adjustment bolt (bottom)	5 mm Allen	15 Nm
	Speedometer clamp bolts	3 mm Allen	3 Nm
	Remote clamp bolt	3 mm Allen	3 Nm
	Throttle clamp bolt	3 mm Allen	3 Nm
	Shifter clamp bolt	Phillips or flat head	6 Nm
	Brake lever clamp bolts	5 mm Allen	6 Nm
Brake	Caliper adapter to frame	5 mm Allen	6–8 Nm
	Caliper to adapter	5 mm Allen	6–8 Nm
	Brake pads to caliper	Cotter pin	n/a
	Brake rotor to hub	T25 Torx bit	7 Nm
Seat	Seat adjustment bolt	6 mm Allen	15 Nm

Recommended Torque Values

Frame Downtube	Controller mounting bolts	6 mm Allen	3 Nm
	Frame cable cover bolts	2.5 mm Allen	tighten securely; do not overtighten
Rear dropout	Rear axle nuts	18 mm wrench	40 Nm
	Torque arm bolt	4 mm Allen	5 Nm
	Derailleur hanger mounting bolt	5 mm Allen	10 Nm
	Derailleur mounting bolt	5 mm Allen	10 Nm
	Derailleur cable clamp bolt	5 mm Allen	6-8 Nm
Bottom bracket and crank	Pedal into crank arm	15 mm pedal wrench	35 Nm
	Crank arm removal info	Crank puller for square taper bottom bracket	n/a
	Crank arm bolt into bottom bracket spindle	8 mm Allen	35 Nm
	Freewheel removal	Contact local dealer	n/a
	Chainring bolts	5 mm Allen	10 Nm
	Kickstand mounting bolts	5 mm Allen	8 Nm
	Bottom bracket and cups	BBT-22 Park Tool	60 Nm

Tools and Torque Values

Accessories	Headlight/front fender mounting bolt	5 mm Allen and 10 mm wrench	6 Nm
	Fender mounting bolts (except at headlight)	4 mm Allen	6 Nm
	Replaceable rear rack mounting bolts	5 mm Allen	6 Nm

Riding Guide

1. Checking List Before Riding

- Whether the handlebar is stable and flexible when turning.
- Whether the right and left switches on the handlebar can work properly or not.
- Whether the throttle can work properly or not.
- Make sure the tires are inflated to the recommended tire pressure (30 PSI).
- Check tire surface, make sure there are no cracks, damages, and foreign matter punctures or attachments.
- Check whether the tread depth is enough, for your safety, tires should be replaced when the tread depth is below the recommended value by the manufacturer.
- Whether any error warning light are on the speedometer.
- Whether the battery capacity is enough for your trip.
- Whether all lights work properly or not.
- Whether the horn works properly or not.
- Whether the mirrors are clean and adjusted to the appropriate angle.
- Whether the brake lever and brake system work properly or not.

Warranty Policy

By purchasing any Emmo Inc products or other brand items sold by Emmo Inc, the customer agrees to the policies and procedures outlined below.

Terms and conditions apply for eligibility of warranty. Please refer to [Terms and Conditions](#).

Any warranty is extended to the original owner with the original purchase paperwork. This portion does not cover the purchase of parts or the purchase of products sold by Emmo Inc that is not an electric bike, electric scooter ebike, electric motorcycle style ebike, electric mobility scooter, kick-style electric scooter, or ride-on toy.

Electric Bicycle

Emmo dealers may charge an assembly fee to assemble the ebike.

- **Comprehensive Warranty (up to 4000km)** There is a Two Year warranty (up to 4000km) for the frame, and motor. One year repair or part replacement is extended to the original owner on controller and other applicable components against manufacturer's defect in workmanship and materials on the e-bikes.
- **Manufacturer's comprehensive warranty** does not cover such parts including, but not limited to: seats, plastic housings and shrouds, pitting, scratches and chips, brake pads, tires, tubes, or damage due to lack of maintenance, accident, misuse or abuse. Damage incurred from water, road salt and other foreign debris or chemicals are not covered by the comprehensive warranty. The labour of any warranty repair will be covered by the original store that the bike was purchased from only when it is being repaired at said store. The parts will be covered by Emmo Inc. You are responsible for providing original purchase paperwork and shipping the item to and from the store.

- Six Month Warranty (up to 4000km) 6 Month warranty on original Batteries and Chargers provided that they have been maintained as instructed by your vehicle hand-book and not subjected to freezing temperatures. For Lithium models, the chargers must match the lithium batteries. Emmo is not responsible for any damage resulting from using another brand or voltage of charger. The customer is responsible for providing original purchase paperwork and shipping the item to and from the store.
- If you are not able to bring the ebike to the location you purchased from, you may be required to ship the item and a copy of your purchase paperwork to Emmo Inc before receiving a replacement item. You are responsible for shipping to Emmo Inc. Once the warranty claim is approved, Emmo Inc will arrange the shipping for the replacement parts and cover the return shipping to you unless expressed otherwise by Emmo Inc. Labour will not be covered by Emmo Inc.
- Certain conditions that may limit or completely void the warranty of your e-bike are: altering the ebike from its original design or its intended use, eg: pulling a trailer, as a delivery vehicle or any commercial use.

Purchased Parts

Please consult your Emmo dealer for more details of the parts policies.

- **Shipping Damage:** Emmo Inc will not be held responsible for any lost, stolen, or damaged items due to any delivery services or courier actions. Report any damage to Emmo Inc within 7 days of receiving the part with pictures for any shipping damage and proof of purchase. Please note the damage on the shipper's proof of Delivery prior to signing off on the shipment. Shipping damage is not covered by Emmo Inc if you choose your own shipping method or freight forwarder. The cost of shipping will not be covered under warranty unless Emmo Inc agrees in writing to cover the shipping cost.
- **Repair and Store Purchases of Emmo Inc Products:** Any warranty is extended to the original owner with the original purchase paperwork. Any return or exchange within 7 days must be in new, unused, and original

packaging. The customer is responsible for notifying Emmo Inc of the return or exchange and the cost of shipping will not be covered under warranty unless Emmo Inc agrees in writing to cover the shipping cost. On all return and exchange items, a restocking fee of 20% will be withheld from the refund amount unless Emmo Inc has agreed to another arrangement in writing. The cost of the item minus the restocking fee will be refunded once the product is returned and determined to be returnable. Restocking fees are 20% of MSRP not including Taxes, Freight/Shipping or PDI. Items out of original packaging will not be accepted.

- **Part Warranty Policy:** All items with warranty must have a valid warranty sticker. For Lithium models, the chargers must match the lithium batteries. Emmo is not responsible for any damage resulting in using another brand or voltage of charger or using an Emmo item with items that are not sold by Emmo Inc. Within 7 days, any items defective by manufacturer quality and are under warranty can be replaced. After 7 days, any items defective in manufacturer quality and are under warranty can be repaired. Warranty does not cover damage due to lack of maintenance, accident, misuse or abuse. Damage incurred from water, road salt and other foreign debris or chemicals. The labour of any warranty repair will be covered by the original store that the Emmo Inc part was purchased from only when it is being repaired at said store. For repairs that are done on items that are not from Emmo Inc, only a 7-day Parts Warranty will be included.
- If the part was paid by financing, you are responsible for any cancellation fees or penalties charged by the third party financing company unless Emmo Inc has agreed to cover the fees in writing. The financing loan agreement will only be cancelled after Emmo Inc has received and approved the returned item.
- For repairs that are done on items that are not from Emmo Inc, only a 7-day Parts Warranty will be included. Emmo Inc is not responsible for items modified from its intended use or purpose resulting in damage to the ebike or injury to the customer or third party.

 **NOTICE:** If you have any questions, please contact your local dealer.

E-Bike Registration

Once you have purchased an EMMO E-Bike, you can register your vehicle with us to validate your warranty. In order to register your E-Bikes, please follow the steps listed below:

1. Fill out the following form:

E-BIKE REGISTRATION	
Invoice Number:	
Store Location:	
Customer Name:	
Address:	
Phone Number:	
Email:	

E-Bike Registration

Survey:

How did you find out about EMMO Inc.? (Please select the options that apply)

- Returning Customer
- Family / Friend
- Passing by Store
- Kijiji
- TERA
- Google
- Yelp
- Other _____

2. Send the information listed above to our email: info@emmo.ca

3. Wait for a confirmation e-mail from EMMO Inc.

Contact Us

LOCATION

EMMO Mississauga

1224 Dundas St E, Unit 6
Mississauga, ON L4Y 2C5
Canada

EMMO Vaughan

1750 Steeles Avenue West, Unit 15-17
Concord, ON L4K 1S6
Canada

Contact

Toll Free: +1-888-217-1217

Email: service@emmo.ca

EMMO Toronto

438 Spadina Ave, Unit 2
Toronto, ON M5T 2G8
Canada

Toronto Service Center

8 Oxford Street
Toronto, ON M5T 2G8

Website

www.emmo.ca

www.emmo.ca/pages/contactus