

EMMO KNIGHT TURBO

OWNER'S MANUAL



Preface

An Important Message From EMMO

Thank you for choosing EMMO. Congratulations on your purchase of a new KNIGHT TURBO.

This document is intended as a short introduction to your new e-bike. It contains essential safety, performance and service information. Please read and understand this manual fully before assembling and riding your bike. Be sure to watch the official Emmo KNIGHT TURBO assembly video available at <https://emmo.ca/pages/e-bike-assembly-guide>.

Additional information about your bike can be found on our website at www.emmo.ca.

Be sure to check all hardware for correct torque during assembly.

Illustrations

Illustrations shown in this document may differ in detail from the exact configuration on your particular e-bike model. The illustrations are a general reference for instruction and description purposes only.

Service & Support

If you have questions after reading this manual and watching the assembly video, please feel free to contact us.

E-mail: service@emmo.ca

Toll Free: 1-888-217-1217

Find Emmo dealers near you: <https://emmo.ca/pages/locations>

Content

- About This Manual 5
- About EMMO 6
- Rules and Regulations 7
- Safety Disclaimer 10
- Description..... 13**
 - Schematic Diagram 13
 - Side View 13
 - Handlebar Attachments 14
 - Speedometer 15
- Operation Guide..... 18**
 - How to Turn on the Bike 18
 - Key Ignition/Steering Lock 18
 - Seat 21
 - Remote 24
 - Circuit Breaker 25

Right Switches.....	26
Left Switches.....	27
Throttle.....	28
Charger.....	29
Lead Acid Charger.....	29
Lithium Charger.....	35
Charging Precautions.....	42
Battery.....	43
Battery Safety Precautions.....	43
Disposal.....	44
Storage & Maintenance.....	45
Radio.....	46
USB Charging Port.....	48
Kickstand & Kill Switch.....	49
Passenger Footpeg.....	50
Pedal.....	51
Lights.....	52

Headlight	52
Tail light & Brake Light.....	53
Signal Lights	54
Adjusting the Brake	55
Cleaning / Lubricating the Chain.....	56
Tire Pressure	57
Serial Number	59
Frame Number.....	59
Motor Number	60
Riding Guide	61
Checking List Before Riding	61
Warranty Policy	62
E-Bike Registration	65
Contact Us.....	67

About This Manual

This document is intended as a short introduction to your new e-bike. It contains important safety, performance and service information. Read and understand it along with the information provided during the on-delivery instructions before using the product. Pay special attention to the safety messages as shown here, and keep the manual handy for future reference.



WARNING: Warning about a situation that can cause death, serious physical injury and or heavy material damage if one does not obey the safety instructions.



DANGER: Danger statement indicates a hazardous situation that, if not avoided, has a very high risk of death, serious injury, or property damage.



CAUTION: Caution statement indicates a hazardous situation that, if not avoided, could result in minor or moderate injury or property damage.



NOTICE: Notice is important information that can help you avoid bike/property damage or extend the life of parts and the bike.

About EMMO

Emmo is a proud Canadian company based in Toronto, Ontario. As the leading manufacturer of electric bikes, Emmo has provided over 500,000 people with environmentally-friendly transportation throughout North America. We believe that electric mobility for everyone is a big step in moving towards a zero-emission future.

Since 2009, Emmo has offered a large selection of electric mobility options for commuting and recreation. With our diversity of products, we create high-quality options to accommodate everyone's needs with an emphasis on reducing their carbon footprint. The past decade has proven that Emmo e-bikes are not only a sustainable method of transportation, but that they also push the limits of conventional bikes –to take you further, with less effort and more fun.

Driven by our vision of inspiring more people to lead a greener lifestyle, Emmo strives to give our riders' the best experience possible. Our in-house research and development spans two continents. Our e-bikes are designed in North America and undergo rigorous testing at our state-of-the-art facilities. Throughout this process, every facet of this complex supply chain is vigorously scrutinized to ensure the end product arrives in flawless condition at our four distribution centers in North America. We continue to be at the forefront of the e-bike industry. With over 100 retailers, Emmo is never too far away.

For over 13 years, our strong commitment to design and innovation has resulted in every Emmo product encompassing the latest technology. Our e-bikes exclusively use programmable sine-wave BLDC controllers, allowing higher performance, longer range and enhanced reliability in all conditions. Backed by our comprehensive warranty, we ensure riders are confident in the purchase of their Emmo.

Emmo believes that a greener future is not only possible, it's necessary, and we want to do our part to build greener communities by making e-bikes more accessible.

Rules and Regulations

According to **Canada's Motor Vehicle Safety Regulations (MVSR)**. A qualified e-bike (defined as Power Assist Bicycle) must meet the following requirements:

- The e-bike must have operational pedals
- Upper wattage limit for the motor is 500W
- Maximum speed of an e-bike is 32km/h.

Other requirements include a permanently affixed compliance label from the manufacturer stating that the vehicle is a power-assisted bicycle under statutory requirements in force at the time of manufacture. Currently, there is no license, no insurance, and no vehicle registration required to operate a qualified e-bike according to federal legislation. E-Bike riders share the same rights and responsibilities as other road users.

However, provinces and local municipalities have the power to restrict the use of e-bikes. Most provinces require the rider to wear a helmet. Some provinces have special requirements with regard to the age limit to operate an e-bike, the type of helmet required, even the number of wheels and wheel size. In Ontario, typically, e-bikes are generally treated the same as regular bicycles. According to the Ministry of Transportation of Ontario (MTO), the age limit to operate an e-bike is 16 years old and above; the maximum weight of the bike is 120 kilograms (265 pounds); the bike must have a brake distance of less than 9 meters; Any modifications made to the bike's motor to create speeds greater than 32km/h are prohibited.

As the rules and regulations are subject to changes in different provinces and municipalities. Please check your municipal bylaw and see where you stand.

Rules and Regulations

Useful links:

E-Bike Regulations in Ontario:

<https://www.ontario.ca/page/riding-e-bike>

E-Bike Regulations in British Columbia:

https://www.bclaws.gov.bc.ca/civix/document/id/complete/statreg/151_2002

E-Bike Regulations in Alberta:

<http://www.transportation.alberta.ca/content/doctype45/production/mopedpowerbikes.pdf>

E-Bike Regulations in Manitoba:

<https://web2.gov.mb.ca/laws/statutes/ccsm/h060e.php>

E-Bike Regulations in Saskatchewan:

https://www.sgi.sk.ca/motorcycle/-/knowledge_base/motorcycle-handbook/power-assisted-bicycles1

E-Bike Regulations in Quebec:

<https://saaq.gouv.qc.ca/en/road-safety/modes-transportation/electric-bike>

E-Bike Regulations in New Brunswick:

https://www2.gnb.ca/content/gnb/en/services/services_renderer.200814.Motor_Vehicle_Registration.html

E-Bike Regulations in Nova Scotia:

<https://novascotia.ca/just/regulations/regs/mv18786.htm>

E-Bike Regulations in Prince Edward Island:

<https://www.princeedwardisland.ca/en/information/transportation-and-infrastructure/power-assisted-bicycles>

Know and obey all relevant local laws

It is your responsibility to research and understand relevant laws where you ride your bike. Such laws may cover required helmets and safety gear, required lights and reflectors, required hand signals, where you can legally ride a bike (bikes and ebikes may have different restrictions), how fast you can go, what (if any) cargo or passengers you can carry, rider age, and more. Before using public transportation—buses, trains, etc.—to transport your e-bike, check with the relevant transportation authority for any rules governing weight limits, tire widths, lithium-ion batteries, or any other rules that might pertain to e-bikes. When you ride on the road, assume you must, at minimum, follow all of the rules that cars must follow. For additional information regarding traffic and vehicle laws, contact the road traffic authority in your area.

Safety Disclaimer

This manual contains important safety, performance and service information. Read and understand it along with the information provided during the on-delivery instructions before using the product, and keep it for reference. Ensure that you comprehend all instructions and safety notes/ warnings.



WARNING: Ensure the bike fits you properly before use. You might lose control if the bike is too small or too big for you.

By choosing to ride an electric bicycle you assume the responsibility for the risk of riding an e-bike. The rider is responsible to know and practice the rules of safe and responsible riding, as well as proper use and maintenance of the bicycle.



WARNING: Riders must have the physical condition, reaction time and mental capability to ride and manage traffic, road conditions, and sudden situations. Riders should also familiarize themselves on local bylaws regarding riding an e-bike.

If you have an impairment, hearing impairment, physical impairment, cognitive language impairment, or a seizure disorder, consult your physician before riding any bicycle.





WARNING: Failure to confirm proper installation, compatibility, proper operation or maintenance of any component or accessory can result in serious injury or death. Make sure that correct setup, tightening and torquing to recommended torque values have been completed on your bike.





CAUTION: Before the first ride, familiarize yourself with all the bicycle features. Practice and become proficient

at applying the brakes, using the throttle in a controlled setting before riding in more risky conditions. If you plan to ride at night, familiarize yourself with the lights and signals.

 **WARNING:** Please make sure the bike works properly and safely before each ride or (Inspect key components, including but not limited to the brakes, brake sensors, throttle). Make sure all the hardware, such as the handle bar, hand grips, seat, pedals are secured in place. Have your bike inspected by a licensed mechanic on a regular basis depending on the condition of the bike.

 **DANGER:** **DO NOT** use this product with standard bike trailers, stands, vehicle racks, or accessories that have not been tested for safety and compatibility and verified as safe and compatible with the bike by EMMO. Contact us if you have any question or concern.

 **WARNING:** E-Bikes and e-bike parts have strength and integrity limitations. Extreme riding should not be performed or you will risk damaging the components or becoming seriously injured or killed. This includes but not limited to jumps, stunts, or any riding that exceeds your capabilities.

 **WARNING :**

- Keep the battery away from children and pets.
- Keep the battery & charger away from water and open fire.
- **DO NOT** drop or subject the battery & charger to any big shocks.
- Charge the battery only with the charger that was supplied with the e-bike or supplied by an official EMMO dealer.
- **DO NOT** use the battery & charger for other purposes.

- Never connect the battery's terminals with each other.
- **DO NOT** cover the battery & charger or place objects on top of it during charging.
- **DO NOT** leave the battery & charger unattended while charging.
- Disconnect the charger and the battery immediately if you notice a strange smell or smoke.
- In the unlikely case that the battery is on fire: NEVER try to put the fire out with water. Cover the fire with large amounts of sand and call emergency services immediately.

In no event shall EMMO be responsible for any direct, indirect or consequential damages, including without limitation, personal injury, property damage, or economic losses, whether based on contract, warranty, negligence, or product liability.

Description

1. Schematic Diagram

a. Side View

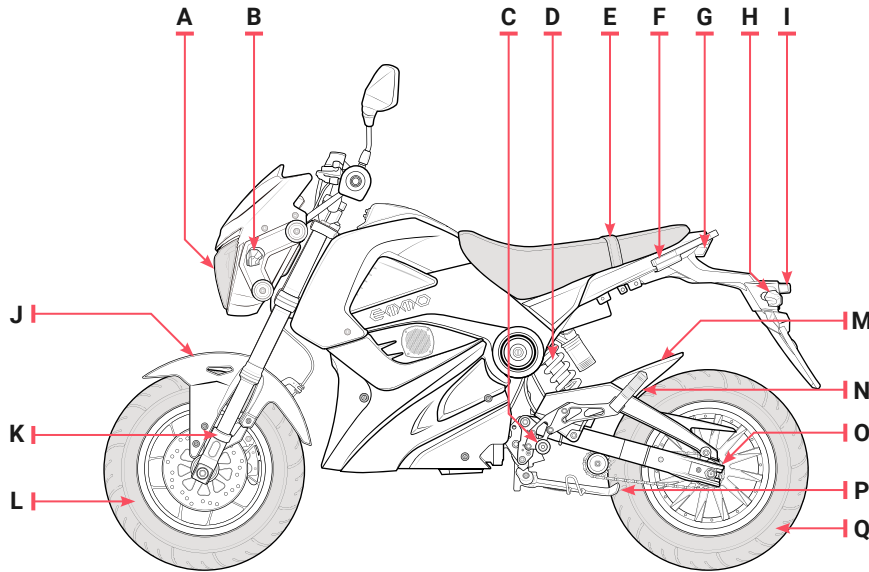

A	Headlight
B	Front Turning Signal Light
C	Driver Footpeg
D	Rear Shocks
E	Seat Cushion
F	Passenger Handles
G	Taillight
H	Rear Turning Signal Light
I	License Plate Light
J	Front Fender
K	Front Shocks
L	Front Wheel
M	Rear Fender
N	Passenger Footpeg
O	Chain
P	Side Kickstand
Q	Rear Wheel

Description

1. Schematic Diagram

b. Handlebar Attachments

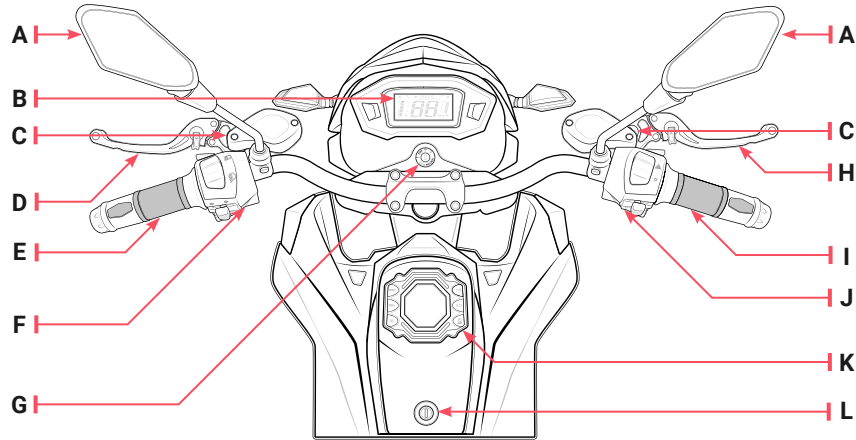

A	Rear View Mirrors
B	Speedometer
C	Brake Fluid Tank
D	Rear Brake Lever
E	Left Grip
F	Left Switch Housing
G	Ignition
H	Front Brake Lever
I	Throttle
J	Right Switch Housing
K	Radio
L	Storage Lock

Description

1. Schematic Diagram







c. Speedometer



Description

1. Schematic Diagram

c. Speedometer



A		High Beam Indicator	When the headlight high beam is on this indicator. Remains on until the high beam is turned off.
B		Left Turning Signal	Flashes when the left turning signal is turned on. This arrow remains flashing until the turning signal is canceled.
C		Battery Strength Indicator	Indicates the current battery strength. (Note: the accurate battery level is shown at full throttle instead of when the bike is still.)
D		Right Turning Signal	Flashes when the right turning signal is turned on. This arrow remains flashing until the turning signal is canceled.
E		Odometer	Total travel distance of the bike (can not be reset).
F		Speed Mode Indicator	Indicates the speed level (this function may not be available for certain models).
G		Current Speed	Indicates the real-time speed of the bike.

Description

1. Schematic Diagram

c. Speedometer

Warning Lights

	Motor Failure	Motor is out of order.
	Throttle Failure	Throttle is out of order.
ECU	Controller Failure	Controller is out of order.
	Brake Sensor Failure	Brake is applied (brake sensor is activated)/ Brake sensor failure.

Operation Guide

1. How to Turn on the Bike

a. Key Ignition/Steering Lock

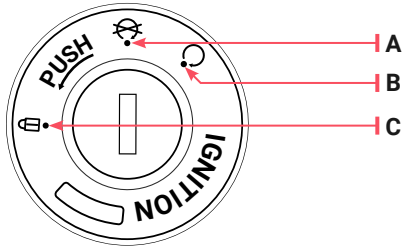

A	Power Off
B	Power On
C	Steering Lock (push)

This is a three-position switch that is located on the body:

- Power Off
- Power On
- Steering Lock

Operation Guide

1. How to Turn on the Bike

a. Key Ignition/Steering Lock

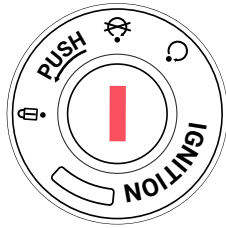

POWER OFF

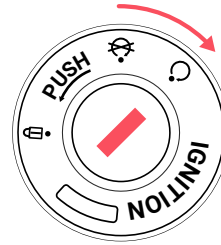

POWER ON

To turn on the bike:

- Insert the key.
- Follow the marking on the ignition, turn the key to the right to turn on the bike.

Operation Guide

1. How to Turn on the Bike

a. Key Ignition/Steering Lock

To lock the steering:

- Turn the ignition off.
- Turn the handlebar all the way to the left.
- Follow the marking on the ignition, push the key in and turn the key anti-clockwise.
- Remove the key.
- Ensure the steering is locked.

To unlock the steering:

- Insert the key
- Push the key in and turn it clockwise
- When unlocked, the steering can be turned freely.

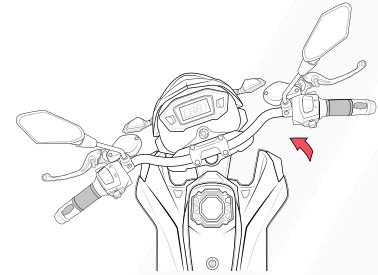

**TURN THE HANDLEBAR
TO THE LEFT**

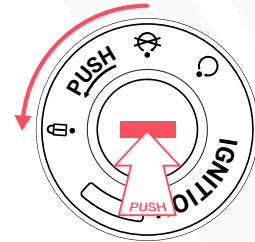

**LOCK THE
STEERING**

Operation Guide

1. How to Turn on the Bike

b. Seat

How to Open the seat

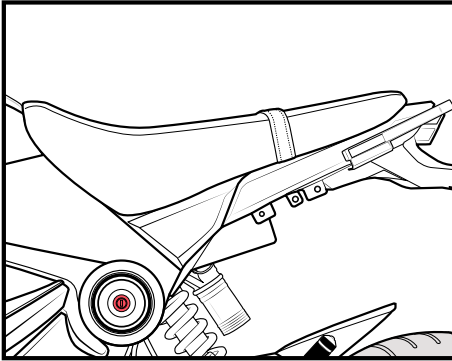

- I. The seat lock is located on the left side of the bike, below the seat cushion.

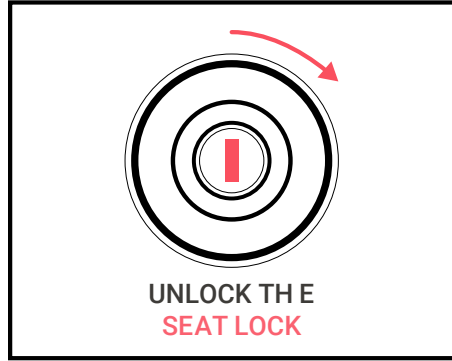

- II. Insert the key and unlock the seat lock by turning the key clockwise.

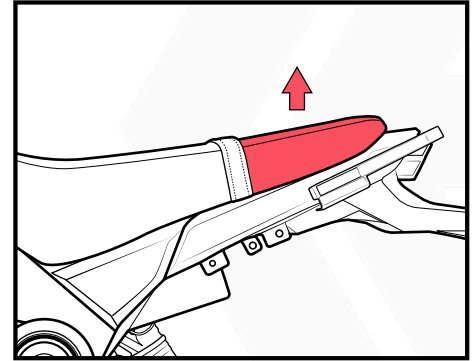

- III. While keeping the seat lock at the unlock position, lift the back of seat up slightly.

Operation Guide

1. How to Turn on the Bike

b. Seat

How to Open the seat

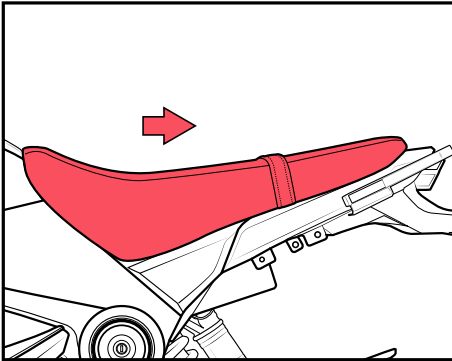

IV. Slide the seat cushion backwards to detach the seat cushion from the frame.

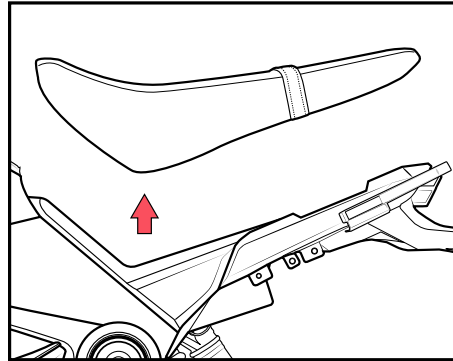

V. Remove the seat cushion.

Operation Guide

1. How to Turn on the Bike

b. Seat

How to close the seat

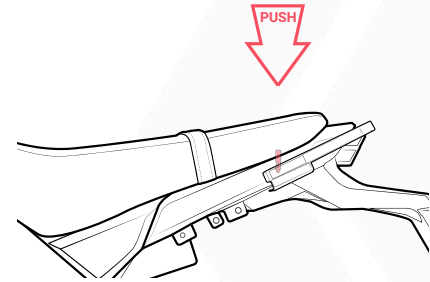
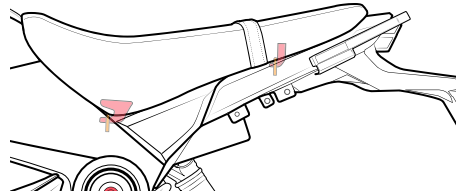
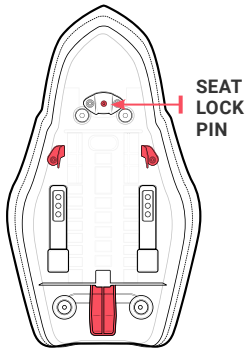

- There are three lock hooks are located on the bottom of the seat cushion.
- Make sure three hooks catch at the hook locks at same time.
- Gently push the seat cushion down at the position of the seat lock pin.
- Make sure the seat is locked properly.

Operation Guide

1. How to Turn on the Bike

c. Remote

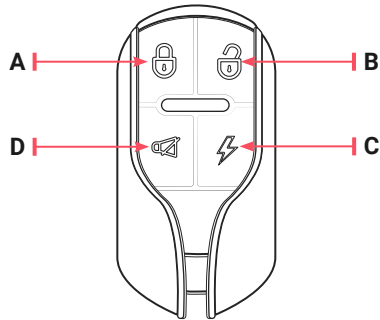

A	Lock Button	Press the button once to activate the anti-theft alarm system.
B	Unlock/Cancel Button	Press the button once to cancel the alarm or to turn off the bike if the bike is turned on with the remote.
C	Power Button	Press the power button twice to turn on the bike with the remote.
D	Panic Button	Press it once, the bike will sound 5 times.

! NOTICE:

- By holding the unlock button, you can adjust the sensitivity of the alarm. 1 'beep' means least sensitive, while 5 'beep's means most sensitive. (This function may not be available in bikes sold in certain areas.)
- If the alarm system is on, please cancel the alarm before you turn on the bike.

Operation Guide

1. How to Turn on the Bike

d. Circuit Breaker

Located in the compartment under the seat, the circuit breaker is the main switch of the bike. When it is turned off, the battery will be disconnected from the system and you will not be able to use the bike, nor will you be able to charge the bike.

Turn on the Circuit Breaker:

- Open the seat(Refer to [page 21](#)).
- Locate the circuit breaker near the seat lock catch.
- Follow the marking on the circuit breaker to turn **ON/OFF** the circuit breaker.
- Close the seat.

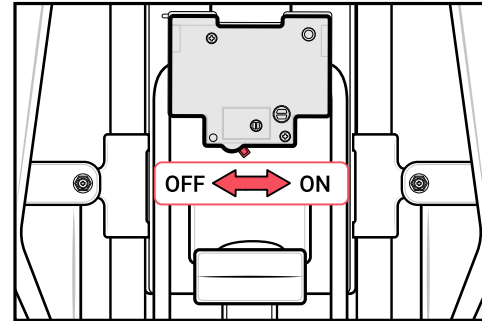





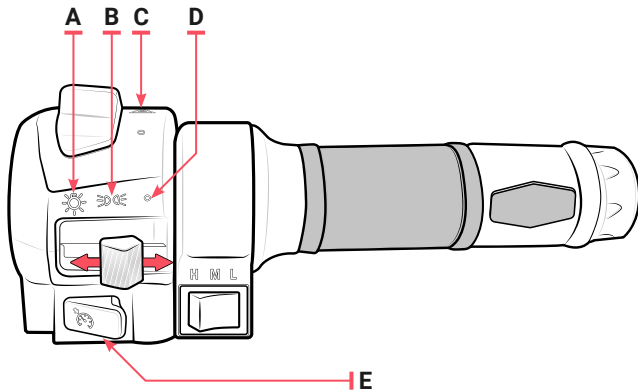

WARNING: The wires inserted into the circuit breaker could have high voltage output. **DO NOT** touch any bare wires. If you have any concern, contact your EMMO dealer for assistance.

Operation Guide

2. Right Switches

The switch housing on the handlebar hold these switches that control the lights, signals, horn and etc..







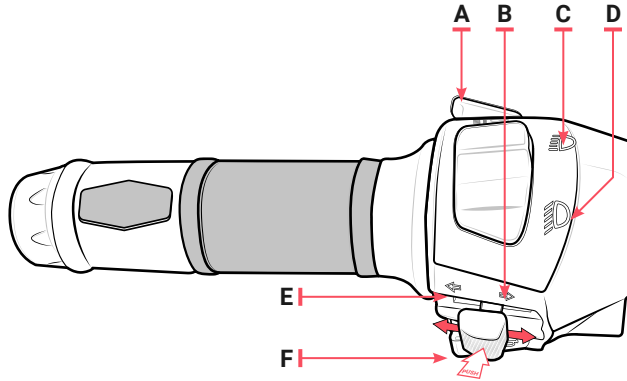

A		Headlight + Tail light	Slide the switch to turn on the headlight and tail light.
B		Tail Light	Slide the switch to turn on the tail light.
C		Emergency Harzard Lights	Press the button to turn on all turning signal lights.
D		Off	Slide the switch to turn off the light.
E		Cruise Control	Press the button to activate the cruise control. To cancel the cruise function, press the button again or apply the brake.

Operation Guide

3. Left Switches



A		High Beam Flasher	Press the button will flash the high beam.
B		Right Turning Signal	Slide the switch to the right will turn on the right side turning signals. (Push the switch lever in to cancel the turning signal).
C		High Beam Light	Press it down will turn the high beam on.
D		Low Beam Light	Press it down will turn the low beam on.
E		Left Turning Signal	Slide the switch to the left will turn on the left side turning signals. (Push the switch lever in to cancel the turning signal).
F		Horn	Press the button to sound the horn.

Operation Guide

4. Throttle

The throttle controls the speed of the e-bike. As shown below, twist the throttle towards you to operate. With the help of the speed mode switch, you can also change the speed setting.

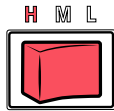
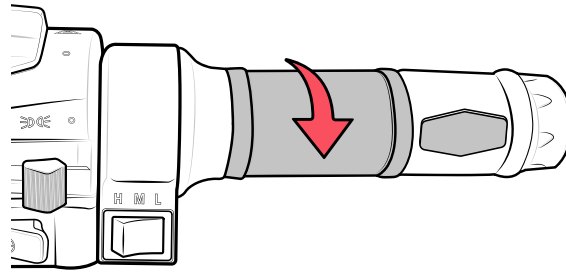

HIGH SPEED

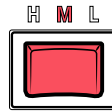

MEDIUM SPEED

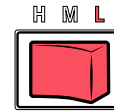

LOW SPEED



WARNING: DO NOT turn the throttle if you are not ready to ride.

Operation Guide

5. Charger

a. Lead Acid Charger

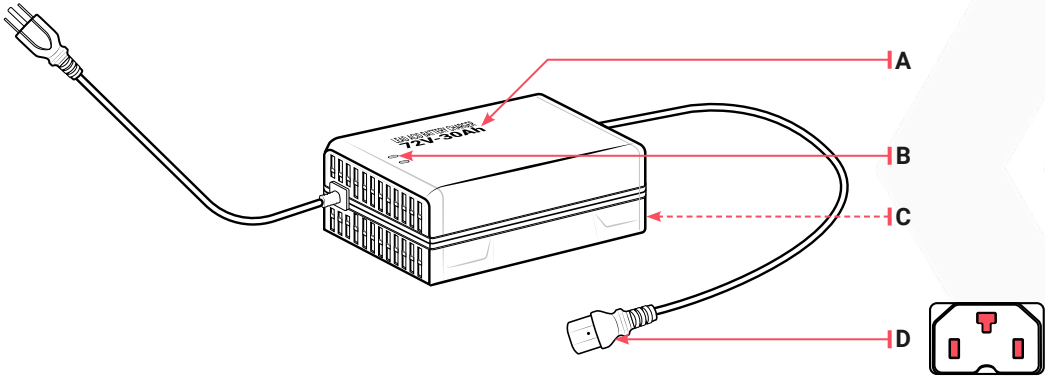

A	Front Label
B	Charging Indicator
C	Charger Specification Label
D	Charging Plug

Operation Guide

5. Charger

a. Lead Acid Charger

A. Front Label

The front label contains brief information of the voltage and capacity of the battery that the charger should be used for (more details are included in the specification label on the back of the charger).



- '72V' means the bike is 72 Voltage.
- '30Ah' means the battery capacity is 30 Amper hour.

Operation Guide

5. Charger

a. Lead Acid Charger

B. Charging Indicator

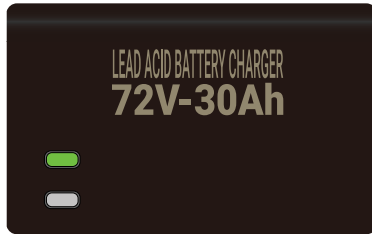

Charging Indicator Explanation:

- During normal charging, red light stays on.
- The indicator will turn green when the battery is fully charged.

! **NOTICE:** If the charger gets warm during regular use, this is normal and is no cause for concern.

Operation Guide

5. Charger

a. Lead Acid Charger

C. Charger Specification Label

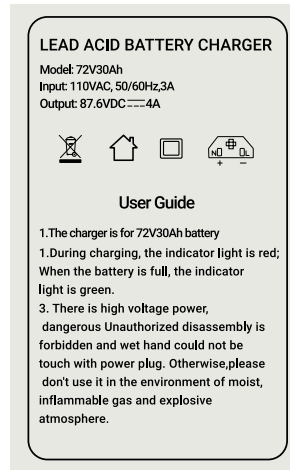

! **NOTICE:** 72V30Ah SLA and 72V32Ah SLA are the same battery/charger based on different rating systems.

Operation Guide

5. Charger

a. Lead Acid Charger

D. Charging Plug (How to Charge)

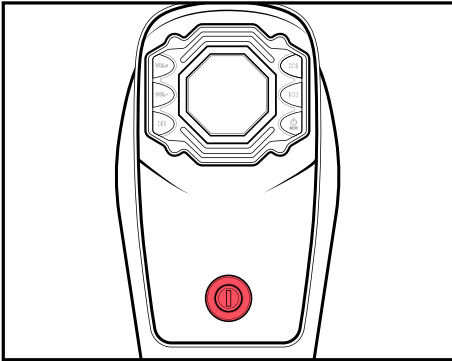

I. Locate the storage lock on the gas tank storage lid.

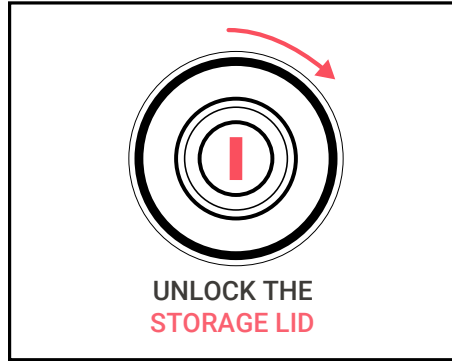

II. Insert the key and turn it clockwise to unlock and open the storage lid.

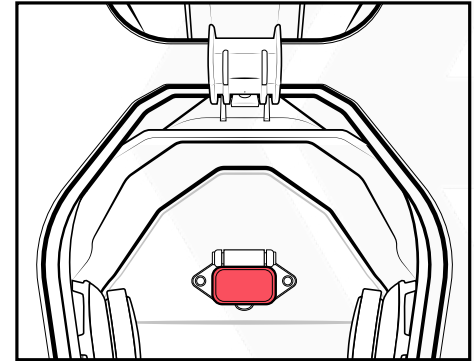

III. The charging port is located in the storage compartment.

Operation Guide

5. Charger

a. Lead Acid Charger

D. Charging Plug (How to Charge)

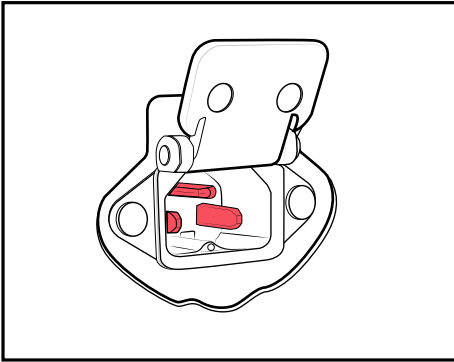

IV. Open the charging port lid.

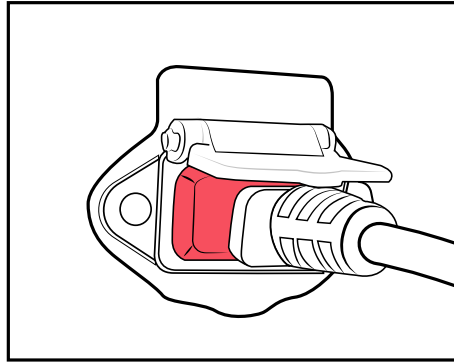

V. Plug the charger.

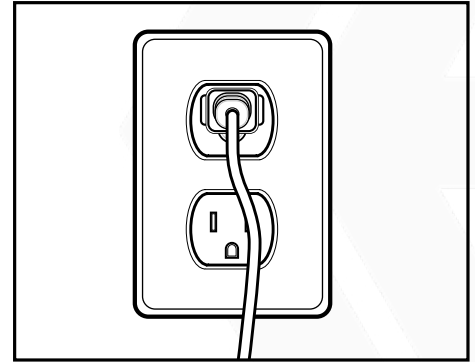

VI. Plug the charger into a regular 110V wall outlet.

Operation Guide

5. Charger

b. Lithium Charger

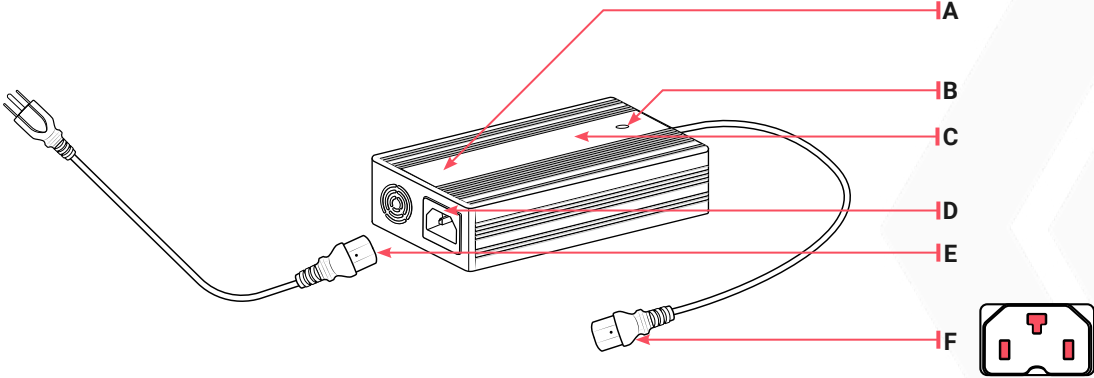

A	Charger Label
B	Charging Indicator
C	Charger Specification Label
D	Power Cord Socket
E	Power Cord
F	Charging Plug

Operation Guide

5. Charger

b. Lithium Charger

A. Charger Label

The front label contains brief information of the voltage and capacity of the battery that the charger should be used for (more details are included in the specification label on the back of the charger).

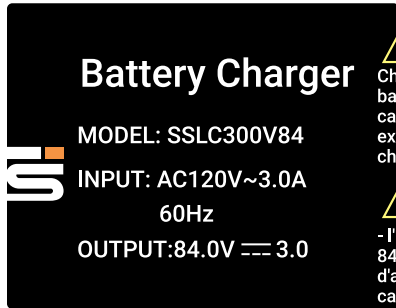

- Charging voltage is 84V
- Charging current is 3A.

Operation Guide

5. Charger

b. Lithium Charger

B. Charging Indicator

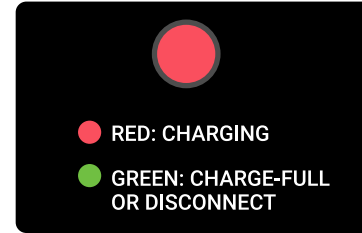
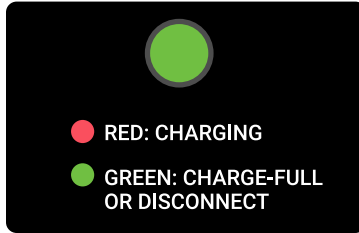

Charging Indicator Explanation:

- During normal charging, red light keeps on.
- The indicator will turn green when the battery is fully charged.

! **NOTICE:** If the charger gets warm during regular use, this is a normal response and is no cause for concern.

Operation Guide

5. Charger

b. Lithium Charger











C. Charger Specification Label

 **CAUTION:** -Indoor use only. Charger only 84V battery type rechargeable batteries. Other types of batteries may burst causing personal injury and damage. Risk of explosive. Read instructions 1 before using charger.

 **ATTENTION**
- l'intérieur seulement, la charge que 84V battery type de piles rechargeables. d'autres types de piles peut éclater et causer des dommages corporels. Risque d'explosion Lire les instructions 1 avant d'utiliser le chargeur 0-30 °C

DANGER:
Risk of electric shock. Do not touch uninsulated portion of output connector or uninsulated battery terminal

DANGER:
Risque de chocs électriques. Ne pas toucher les parties non isolées du connecteur de sortie ou les bornes non isolées de l'accumulateur.



RED: CHARGING

GREEN: CHARGE-FULL OR DISCONNECT

Operation Guide

5. Charger

b. Lithium Charger

D. Power Cord Socket

E. Power Cord

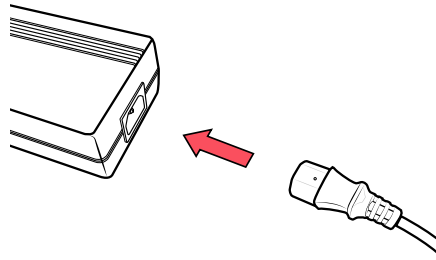

Connecting the charger:

- Plug **E** of the power cable into the device socket **D** on the charger.



WARNING: You MUST NOT plug the power cord directly to the bike/battery. High voltage may damage the bike/battery and cause severe injury.

Operation Guide

5. Charger

b. Lithium Charger

F. Charging Plug (How to Charge)

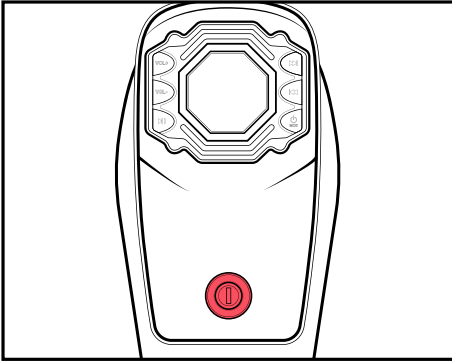

I. Locate the storage lock on the gas tank storage lid.



II. Insert the key and turn it clockwise to unlock and open the storage lid.

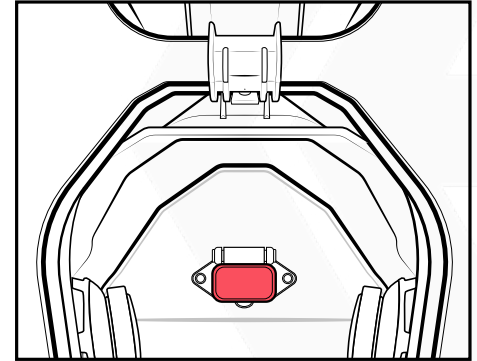

III. The charging port is located in the storage compartment.

Operation Guide

5. Charger

b. Lithium Charger

F. Charging Plug (How to Charge)

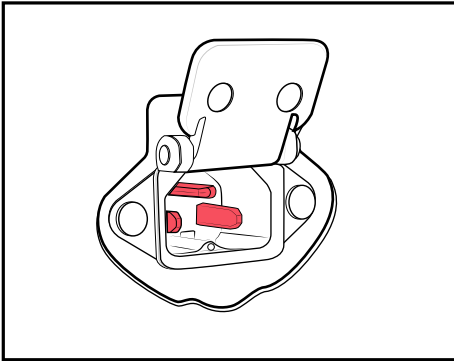

I. Open the charging port lid.

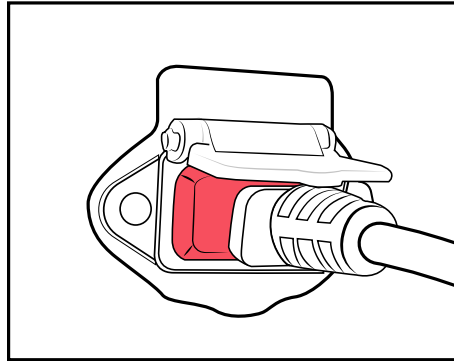

II. Plug the charger.

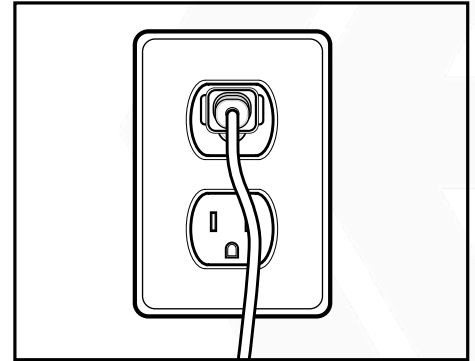

III. Plug the charger into a regular 110V wall outlet.

Operation Guide

5. Charger

c. Charging Precautions



WARNING:

- You must use the compatible charger (approved by EMMO) to charge the battery.
- **DO NOT** submerge or allow the charger to become submerged in water or any liquid.
- **DO NOT** use the charger if the cord becomes frayed, has exposed solution or wires or shows any damage.
- **DO NOT** use the charger if the plastic enclosure or the charging connector is broken, cracked or shows any significant damage.
- If the charger/battery becomes unreasonably hot, please disconnect the charger from the power outlet and contact your EMMO dealer immediately.
- After the charging is completed, please disconnect the charger from the power outlet first.
- Leave the battery and charger out of the reach of children.
- Charge the battery in a dry, well-ventilated space. **DO NOT** charge the battery in the rain /snow.

Operation Guide

6. Battery

a. Battery Safety Precautions

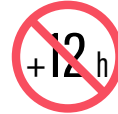

- Be sure to use the original/compatible battery (approved by EMMO). Using batteries from other brands may lead to severe accidents.
- Inspect the battery for any damage, leaking, overheating or smoking.
- Always charge between **0°C to 45°C**, charging outside of this range may cause permanent damage to battery.
- **DO NOT** lift the battery by its connectors or cables.
- **DO NOT** charge the battery for over 12 hours.
- **DO NOT** subject the battery to impact.
- **DO NOT** subject the battery to water.
- **DO NOT** subject the battery to heat or open fire.
- **DO NOT** open the battery pack by yourself. If you need any assistance, please contact your EMMO dealer.

Operation Guide

6. Battery

b. Disposal



This product contains sealed lead acid batteries which must be disposed or recycled in an environmentally safe manner. Do not dispose of the batteries in your household trash. Do not dispose of the batteries in a fire, this could cause the batteries to leak or explode. The incineration, disposal in landfill and or placing sealed lead acid batteries with household trash is prohibited by law in most areas.

NOTICE:

- Used batteries must be treated as hazardous waste.
- Batteries must be disposed of in accordance with the the regulations set forth by your local government/organizations.
- In case of uncertainty, please contact EMMO customer service department at service@emmo.ca

Operation Guide

6. Battery

c. Storage & Maintenance

- For storage, please disconnect the battery from the bike and charge the battery on a regular basis (at least once a month).
- Battery packs and chargers need to be stored in a clean, dry, ventilated place, avoid contact with corrosive material, and keep them away from heat and fire.
- Battery storage condition: temperature:-20 - 35°C , humidity ≤ 65%RH.

Operation Guide

7. Radio



Operation Guide

7. Radio

A	Volume Up	Turn the volume up.
B	Volume Down	Turn the volume down.
C	Play / Pause	MP3 - Press the button once to pause. Press again to continue to play. FM radio - Hold the button for 5 seconds to search for available channels. Once finished the system will stop at the first channel.
D	Previous	MP3 - Press the button once to play the previous song in the list. FM radio - Press the button once to switch to previous channel in the list.
E	Next	MP3 - Press the button once to play the next song in the list. FM radio - Press the button once to switch to next channel in the list. Hold the button to search for available channels (initialization).
F	Power / Mode Switch	Press once to turn on the radio system. 1. Hold the button to switch to MP3 mode.You can pair Bluetooth device with the built-in MP3 player(named 73). 2. Hold the button again to switch to FM radio mode. Press to turn off the radio system.

Operation Guide

8. USB Charging Port

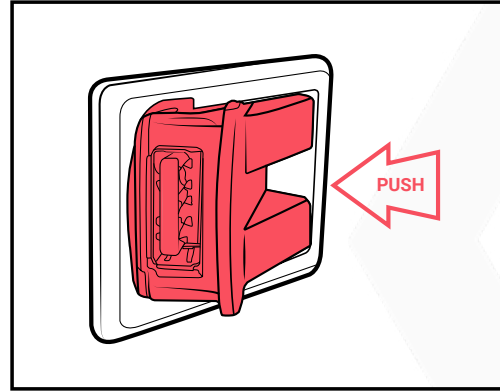
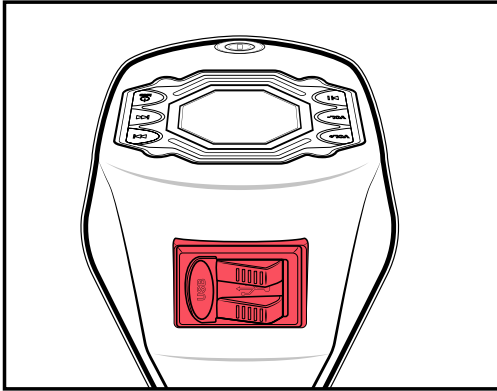

- locate usb charging port on the storage lid.
- Push down on the higher side to reveal the spring loaded port.
- Insert usb to charge your device.

Operation Guide

9. Kickstand & Kill Switch

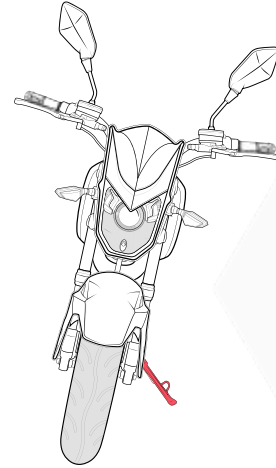
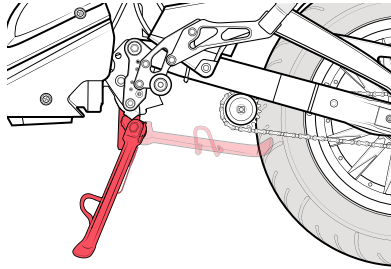

How to use the side kickstand and kill switch:

- Kick the side stand down and gently lean the bike on the side kickstand.
- Make sure it is stable before you leave your bike.
- When the side kickstand is kicked down, the kickstand kill switch is turned on, which cuts off the motor power.

Operation Guide

10. Passenger Footpeg

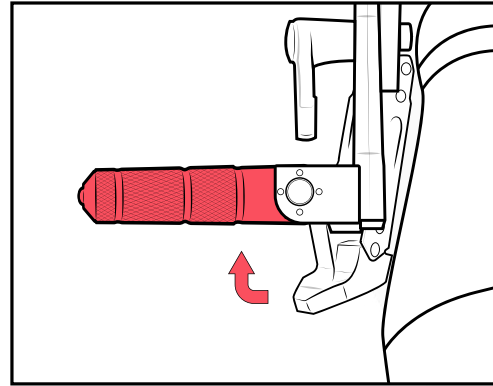
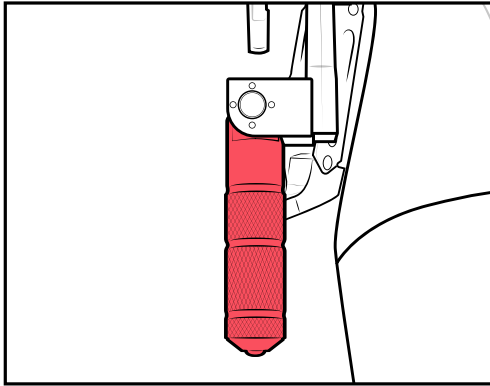

Foldable Passenger Footpegs:

- Passenger footpegs are located near the rear wheel.
- Unfold the footpegs as shown when needed.

Operation Guide

11. Pedal

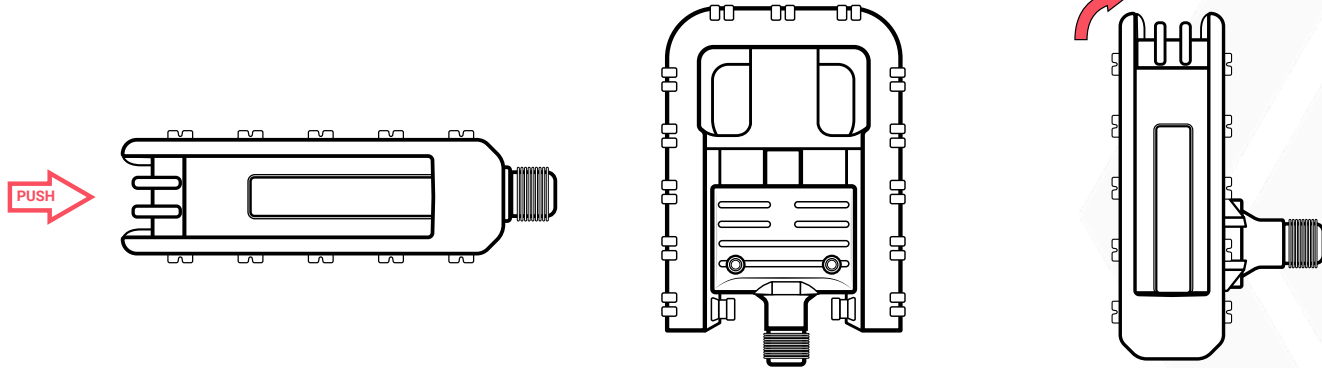

How to fold the pedals:

- Push the pedal from the side (as shown).
- Fold the pedal up while you continue pushing from the side.

Operation Guide

12. Lights

a. Headlight

The headlight assembly has multiple operation modes - high beam, low beam and daytime running light, to accommodate your needs under different conditions.

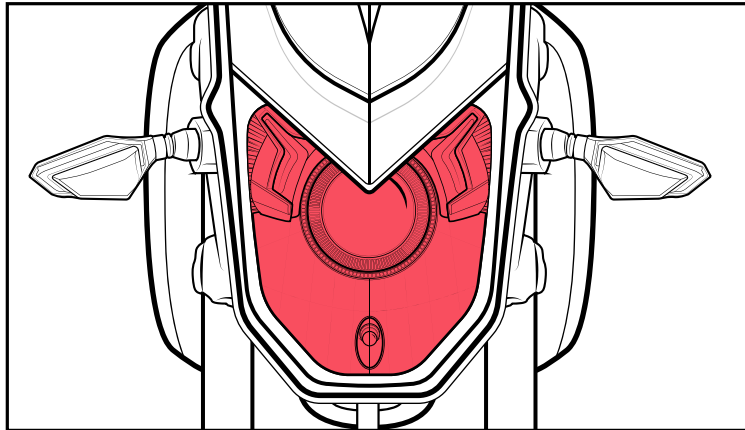

Operation Guide

11. Lights

b. Tail light & Brake Light

The tail light increases your visibility to others at night/under dark conditions. The brake light signals to the traffic behind you that your E-bike is slowing down so that they can adjust their speed accordingly.

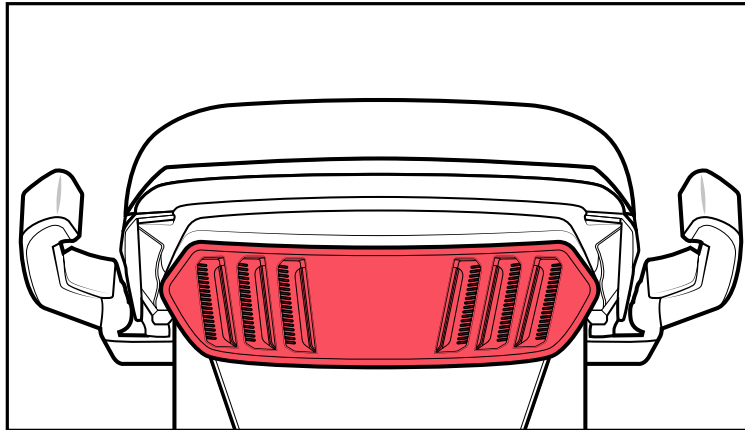

Operation Guide

11. Lights

c. Signal Lights

The built-in turning signals give the nearby traffic a better insight of your intended route.

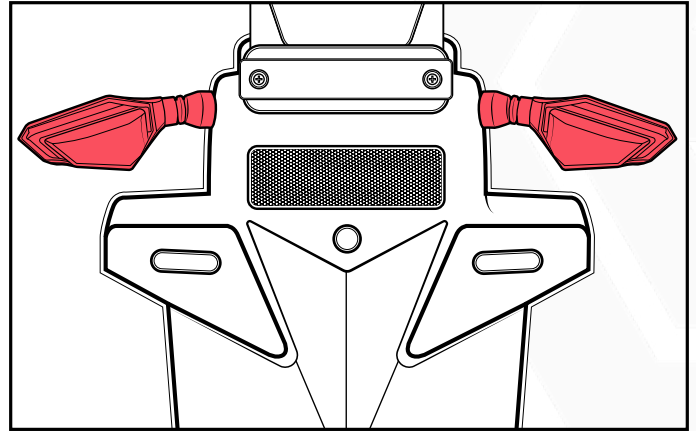
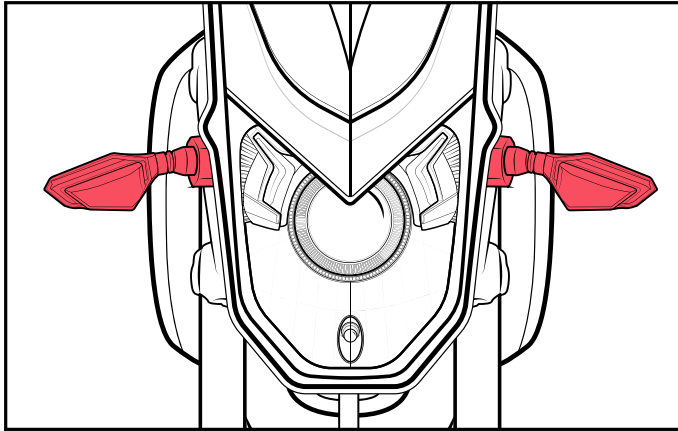

Operation Guide

13. Adjusting the Brake

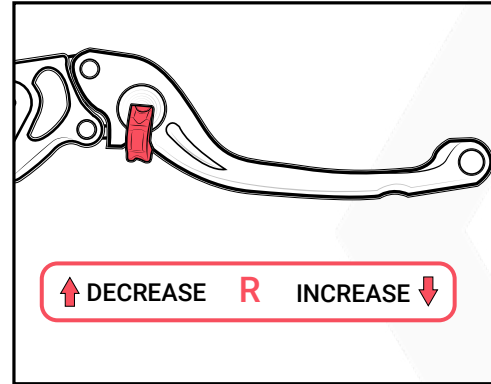
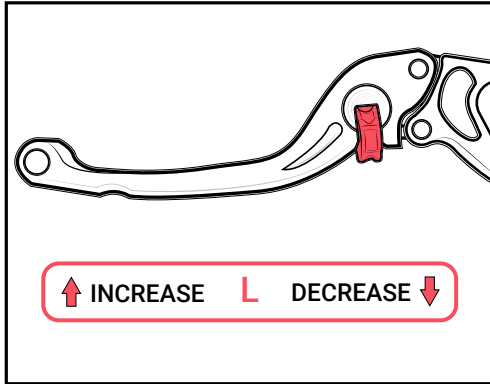

How to Adjust:

- The adjustment nut is located on the brake lever. Use it to adjust the gap between the lever and the hand grip.

Operation Guide

14. Cleaning / Lubricating the Chain

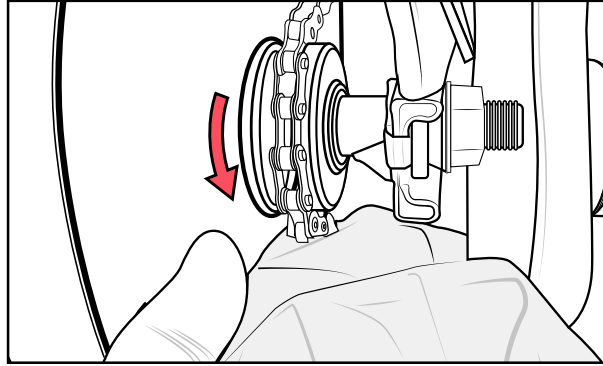

How to Clean the Chain:

- Put the bike on the service stand lean the bike on the stand.
- Locate the chain on the left side of the bike, near the rear wheel hub.
- Hold a clean cloth to the chain (as shown).
- Turn the pedal to clean the chain.
- Apply new bicycle chain oil to the sprocket and chain.

Operation Guide

15. Tire Pressure

It is recommended to check the tire pressure on a regular basis to keep things at their best working conditions.

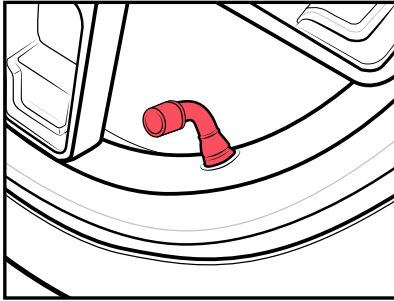

I. Locate the valve on the rim.

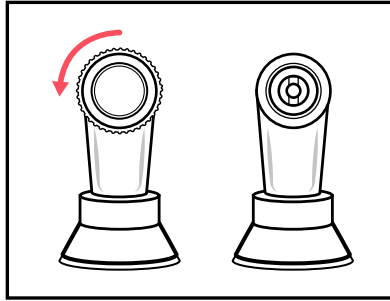

II. Remove the valve cap.

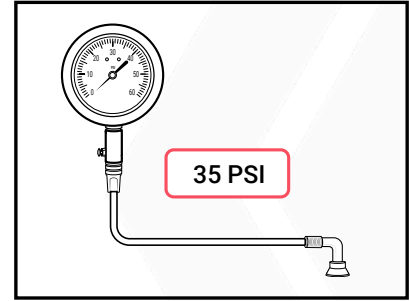

III. Use an air pump with gauge to adjust the tire pressure to 35 PSI.

Tire pressure affects the following:

- Service life of the tires and other components of the bike.
- Riding safety.

Operation Guide

14. Tire Pressure

- Riding comfort
- Travel distance



WARNING:

- You **MUST** inflate the tire to the recommended tire pressure before the first ride. Failure to do so may damage your bike and void your warranty.
- **DO NOT** over-inflate, as this could damage the tire or wheel. (The recommended tire pressure range is marked on both tires by the manufacturers.)

Operation Guide

16. Serial Number

a. Frame Number

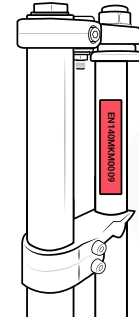
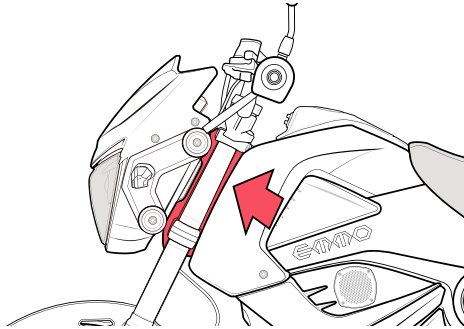

Find the Frame Number:

- The frame number is located on the neck of frame.
- You will find the Frame Number engraved on the frame.

Operation Guide

15. Serial Number

b. Motor Number

Located on the motor.

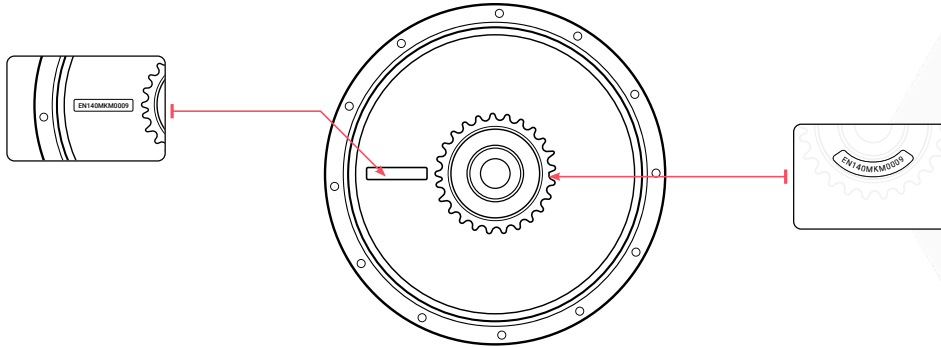

The motor number could be located at the following locations:

- **Location 1:** On the motor cover plate.
- **Location 2:** Behind the sprocket on the motor.

Riding Guide

1. Checking List Before Riding

- Whether the handlebar is stable and flexible when turning.
- Whether the right and left switches on the handlebar can work properly or not.
- Whether the throttle can work properly or not.
- Make sure the tires are inflated to the recommended tire pressure (35 PSI).
- Check tire surface, make sure there are no cracks, damages, and foreign matter punctures or attachments.
- Check whether the tread depth is enough, for your safety, tires should be replaced when the tread depth is below the recommended value by the manufacturer.
- Whether any error warning light are on the speedometer.
- Whether the battery capacity is enough for your trip.
- Whether all lights work properly or not.
- Whether the horn works properly or not.
- Whether the mirrors are clean and adjusted to the appropriate angle.
- Whether the brake oil is enough.
- Whether the brake lever and brake system work properly or not.

Warranty Policy

By purchasing any Emmo Inc products or other brand items sold by Emmo Inc, the customer agrees to the policies and procedures outlined below.

Terms and conditions apply for eligibility of warranty. Please refer to [Terms and Conditions](#).

Any warranty is extended to the original owner with the original purchase paperwork. This portion does not cover the purchase of parts or the purchase of products sold by Emmo Inc that is not an electric bike, electric scooter ebike, electric motorcycle style ebike, electric mobility scooter, kick-style electric scooter, or ride-on toy.

Electric Scooter E-Bike

Emmo dealers may charge an assembly fee to assemble the ebike.

- **Comprehensive One Year Warranty(up to 6000km)** Two year manufacturer warranty on the frame. One year repair or part replacement is extended to the original owner on the swing-arm, motor, and controller against manufacturer's defect in workmanship and materials on all e-bikes, mobility scooters.
- Manufacturer's comprehensive warranty does not cover such parts including, but not limited to: seats, plastic housings and shrouds, pitting, scratches and chips, brake pads, tires, tubes, or damage due to lack of maintenance, accident, misuse or abuse. Damage incurred from water, road salt and other foreign debris or chemicals are not covered by the comprehensive warranty. The labour of any warranty repair will be covered by the original store that the Electric Bike was purchased from only when it is being repaired at said store. The parts will be covered by Emmo Inc. You are responsible for providing original purchase paperwork and shipping the item to and from the store.

- **Six Month Warranty** Six month warranty on original Batteries and Chargers provided that they have been maintained as instructed by your vehicle hand-book and not subjected to freezing temperatures. For Lithium models, the chargers must match the lithium batteries. Emmo is not responsible for any damage resulting in using another brand or voltage of charger. The customer is responsible for providing original purchase paperwork and shipping the item to and from the store.
- If you are not able to bring the ebike to the location you purchased from, you may be required to ship the item and a copy of your purchase paperwork to Emmo Inc before receiving a replacement item. You are responsible for shipping to Emmo Inc. Once the warranty claim is approved, Emmo Inc will arrange the shipping for the replacement parts and cover the return shipping to you unless expressed otherwise by Emmo Inc. Labor will not be covered by Emmo Inc.
- Certain conditions that may limit or completely void the warranty of your e-bike are: altering the ebike from its original design or its intended use, eg: pulling a trailer, as a delivery vehicle or any commercial use.

Purchased Parts

Please consult your Emmo dealer for more details of the parts policies.

- **Shipping Damage:** Emmo Inc will not be held responsible for any lost, stolen, or damaged items due to any delivery services or courier actions. Report any damage to Emmo Inc within 7 days of receiving the part with pictures for any shipping damage and proof of purchase. Please note the damage on the shipper's Bill of Delivery prior to signing off on the shipment. Shipping damage is not covered by Emmo Inc if you choose your own shipping method or freight forwarder. The cost of shipping will not be covered under warranty unless Emmo Inc agrees in writing to cover the shipping cost.
- **Repair and Store Purchases of Emmo Inc Products:** Any warranty is extended to the original owner with the original purchase paperwork. Any return or exchange within 7 days must be in new, unused, and

original packaging. The customer is responsible for notifying Emmo Inc of the return or exchange and the cost of shipping will not be covered under warranty unless Emmo Inc agrees in writing to cover the shipping cost. On all return and exchange items, a restocking fee of 20% will be withheld from the refund amount unless Emmo Inc has agreed to another arrangement in writing. The cost of the item minus the restocking fee will be refunded once the product is returned and determined to be returnable. Restocking fees are 20% of MSRP not including Taxes, Freight/Shipping or PDI. Items out of original packaging will not be accepted.

- **Part Warranty Policy:** All items with warranty must have a valid warranty sticker. For Lithium models, the chargers must match the lithium batteries. Emmo is not responsible for any damage resulting in using another brand or voltage of charger or using an Emmo item with items that are not sold by Emmo Inc. Within 7 days, any items defective by manufacturer quality and are under warranty can be replaced. After 7 days, any items defective in manufacturer quality and are under warranty can be repaired. Warranty does not cover damage due to lack of maintenance, accident, misuse or abuse. Damage incurred from water, road salt and other foreign debris or chemicals. The labour of any warranty repair will be covered by the original store that the Emmo Inc part was purchased from only when it is being repaired at said store. For repairs that are done on items that are not from Emmo Inc, only a 7-day Parts Warranty will be included.
- If the part was paid by financing, you are responsible for any cancellation fees or penalties charged by the third party financing company unless Emmo Inc has agreed to cover the fees in writing. The financing loan agreement will only be cancelled after Emmo Inc has received and approved the returned item.
- For repairs that are done on items that are not from Emmo Inc, only a 7-day Parts Warranty will be included. Emmo Inc is not responsible for items modified from its intended use or purpose resulting in damage to the ebike or injury to the customer or third party.

 **NOTICE:** If you have any questions, please contact your local dealer.

E-Bike Registration

Once you have purchased an EMMO E-Bike, you can register your vehicle with us to validate your warranty. In order to register your E-Bikes, please follow the steps listed below:

1. Fill out the following form:

E-BIKE REGISTRATION	
Invoice Number:	
Store Location:	
Customer Name:	
Address:	
Phone Number:	
Email:	

E-Bike Registration

Survey:

How did you find out about EMMO Inc.? (Please select the options that apply)

- Returning Customer
- Family / Friend
- Passing by Store
- Kijiji
- TERA
- Google
- Yelp
- Other _____

2. Send the information listed above to our email: info@emmo.ca

3. Wait for a confirmation e-mail from EMMO Inc.

Contact Us

LOCATION

EMMO Mississauga

1224 Dundas St E, Unit 6
Mississauga, ON L4Y 2C5
Canada

EMMO Vaughan

1750 Steeles Avenue West, Unit 15-17
Concord, ON L4K 1S6
Canada

Contact

Toll Free: +1-888-217-1217

Email: service@emmo.ca

EMMO Toronto

438 Spadina Ave, Unit 2
Toronto, ON M5T 2G8
Canada

Toronto Service Center

8 Oxford Street
Toronto, ON M5T 2G8

Website

www.emmo.ca

www.emmo.ca/pages/contactus