

**EMMO**

GREEN YOUR LIFE

# USER'S MANUAL



**Emmo  
F7 S**

# CAUTIONS

**This manual contains important safety, performance and service information. Read and understand it along with the information provided during the on-delivery instructions before using the product, and keep it for reference.**

EMMO

© 2019 Emmo Inc. All rights reserved. No texts, details, or illustrations from this Manual may be reproduced or distributed, or become the subject of unauthorized use for commercial purposes. Should you discover any errors, we would be grateful if you would bring them to our attention.

# MENU

<b>About EMMO</b>	<b>4</b>
<b>Rules and Regulations of Riding an E-Bike</b>	<b>5</b>
<b>Parts Overview</b>	<b>6</b>
<b>Control Pad</b>	<b>8</b>
<b>Adjustment</b>	<b>9</b>
<i>Headlebar Height</i>	<b>9</b>
<i>Handlebar Tilt Angle</i>	<b>11</b>
<i>Seat Height</i>	<b>12</b>
<b>Turn on the Bike</b>	<b>14</b>
<b>Gear Shifter</b>	<b>15</b>
<b>Throttle</b>	<b>16</b>
<b>Horn</b>	<b>17</b>
<b>Safety Instructions</b>	<b>18</b>
<b>How to ride</b>	<b>19</b>
<b>How to charge</b>	<b>20</b>
<b>How to remove the battery</b>	<b>22</b>
<b>How to fold the bike</b>	<b>25</b>
<b>Maintenance</b>	<b>29</b>
<b>E-Bike Registration Form</b>	<b>30</b>

# ABOUT EMMO

*Established since 2009, Emmo Inc. is a proud Canadian venture that is focused on creating a more sustainable future by providing high quality electric bicycles. We offer a wide variety of E-bikes that are suitable for leading a greener, and more stylish, way of living. Emmo E-bikes are priced competitively with other green solutions. At Emmo, you will get the best e-bikes and also receive the best service.*

EMMO



# **RULES and REGULATIONS**

## ***of riding an e-bike***

According to Canada's Motor Vehicle Safety Regulations (MVSr). A qualified e-bike (defined as Power Assist Bicycle) must meet following requirements:

- The e-bike must have operable pedals
- Upper wattage limit for the motor is 500W.
- Maximum speed of an e-bike is 32km/h.

Other requirements include a permanently affixed compliance label from the manufacturer stating that the vehicle is a power-assisted bicycle under statutory requirements in force at the time of manufacture. Currently, there is no license, no insurance and no vehicle registration required to operate a qualified e-bike according to federal legislation. E-Bike riders share the same rights and responsibilities as other road users.

However, provinces and local municipalities have the power to restrict the use of e-bikes. Most provinces require the rider to wear a helmet. Some provinces have special requirements with regard to the age limit to operate an e-bike, the type of helmet required, even the number of wheels and wheel size. In Ontario, typically, e-bikes are generally treated the same as regular bicycles. According to the Ministry of Transportation of Ontario (MTO), the age limit to operate an e-bike is 16 years old and above; the maximum weight of the bike is 120 kilograms (265 pounds); the bike must have a brake distance of less than 9 meters; Any modifications made to the bike's motor to create speeds greater than 32km/h are prohibited.

As the rules and regulations are subject to changes in different provinces and municipalities. Please check your municipal bylaw and see where you stand.

# 1. PARTS OVERVIEW

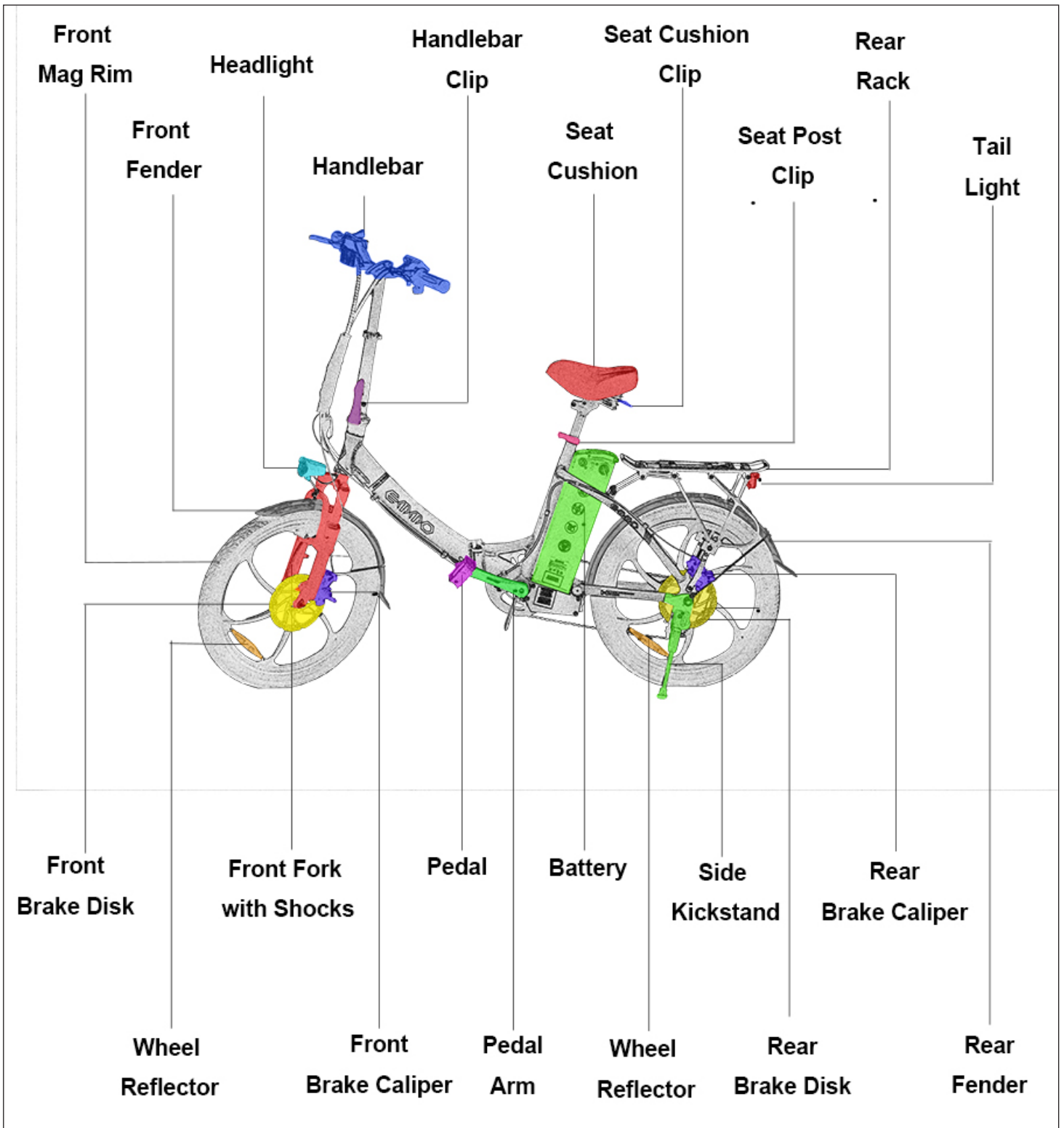

# 1. PARTS OVERVIEW

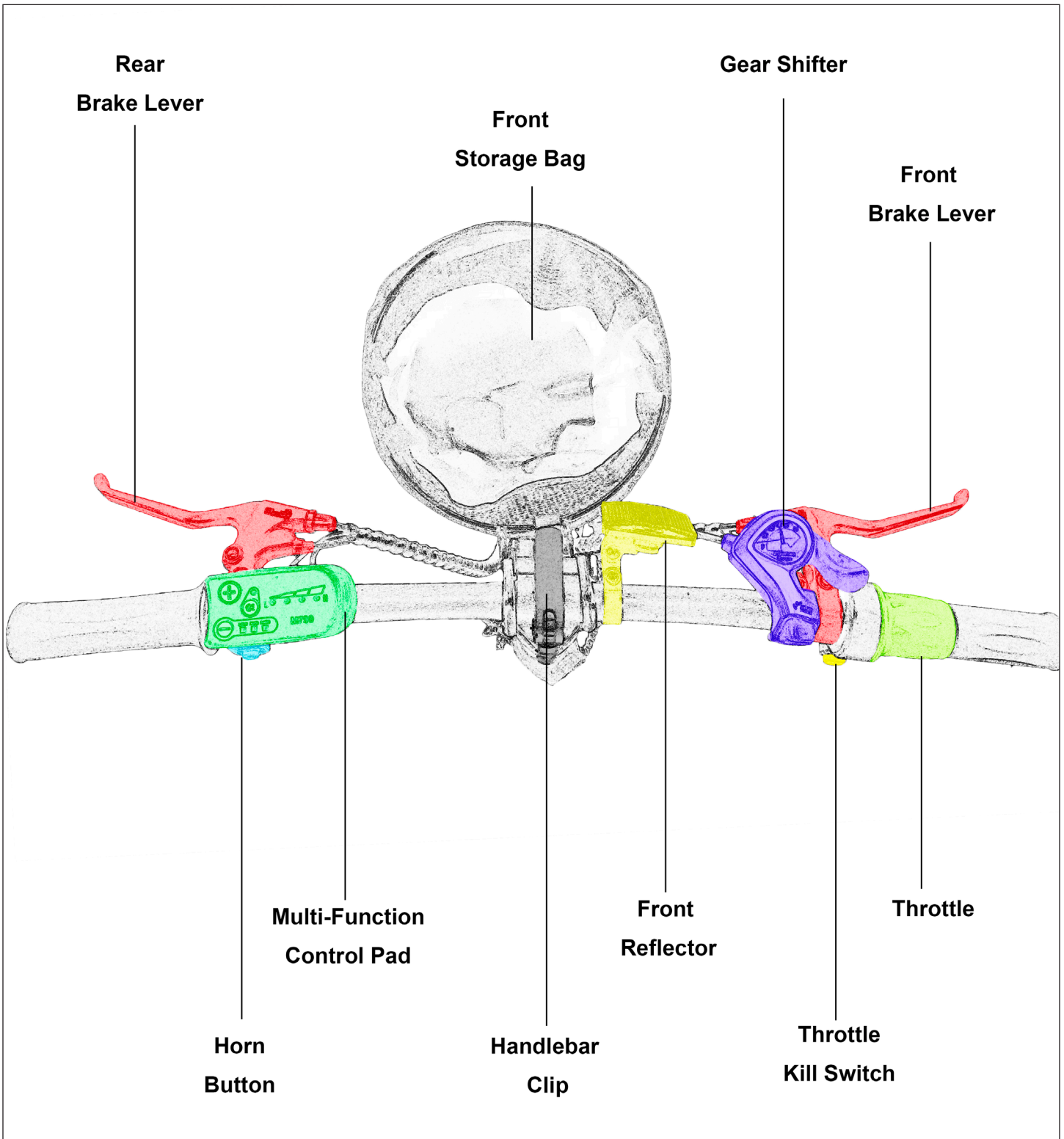

## 2. CONTROL PAD

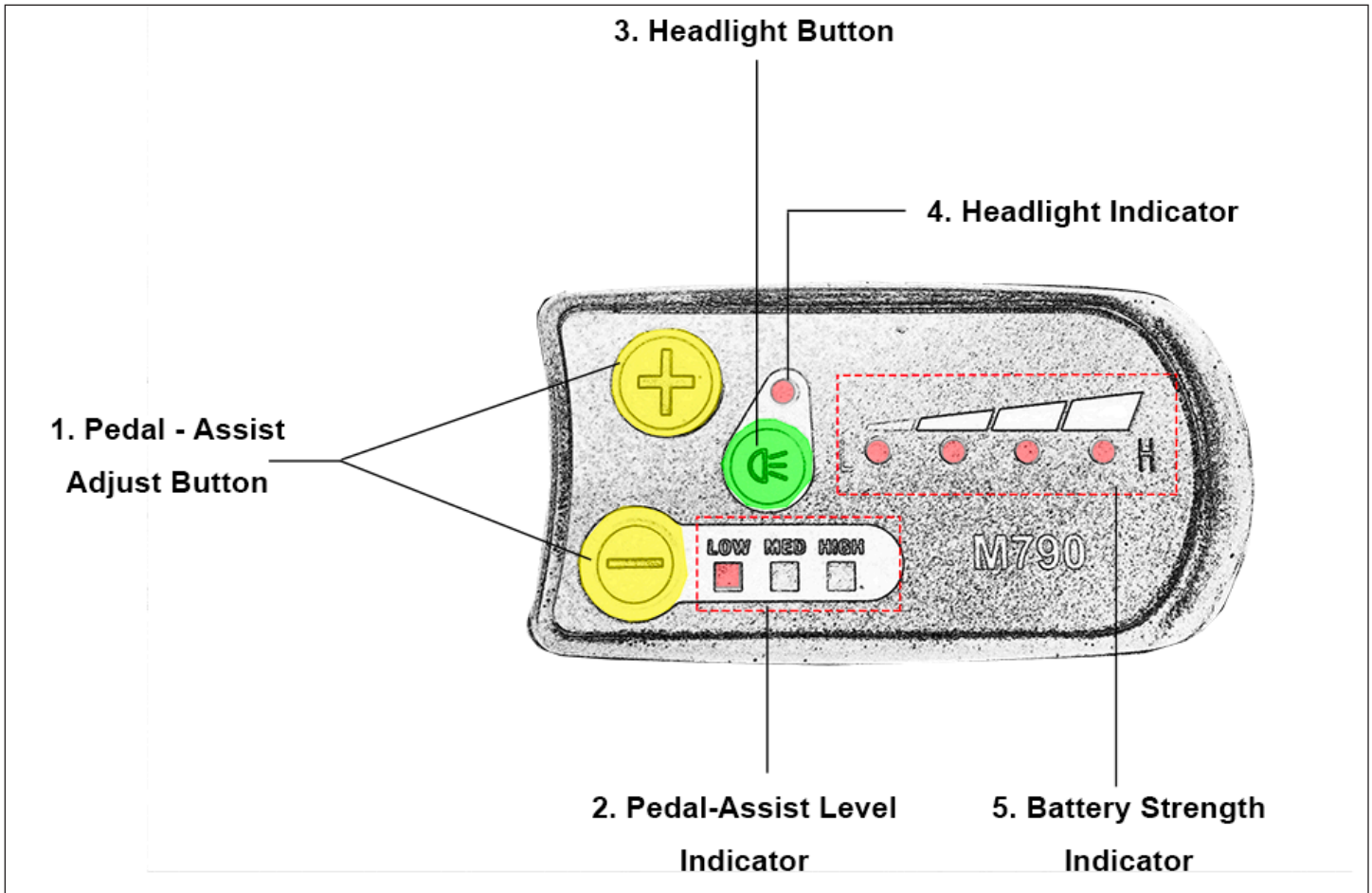

**1. Pedal-Assist Adjust Buttons:** Press ' + ' to raise the pedal-assist level. Press ' - ' to lower the pedal-assist level.

**2. Pedal-Assist Level Indicator:** 3 different levels- low, medium and high. The higher the level is, the easier for you to pedal.

**3. Headlight Button:** Press the button to turn on the headlight. Press it again to turn the headlight off.

**4. Headlight Indicator:** The red indicator will be on if the headlight is on.

**5. Battery Strength Indicator:** 4 dots~Fully Charged, 3 dots~75% Left, 2 dots~50% Left, 1 dot~ less than 25% Left.

**Warning:** You should charge the battery immediately if the battery strength is lower than 25%.

# 3. ADJUSTMENT

- HANDLEBAR HEIGHT

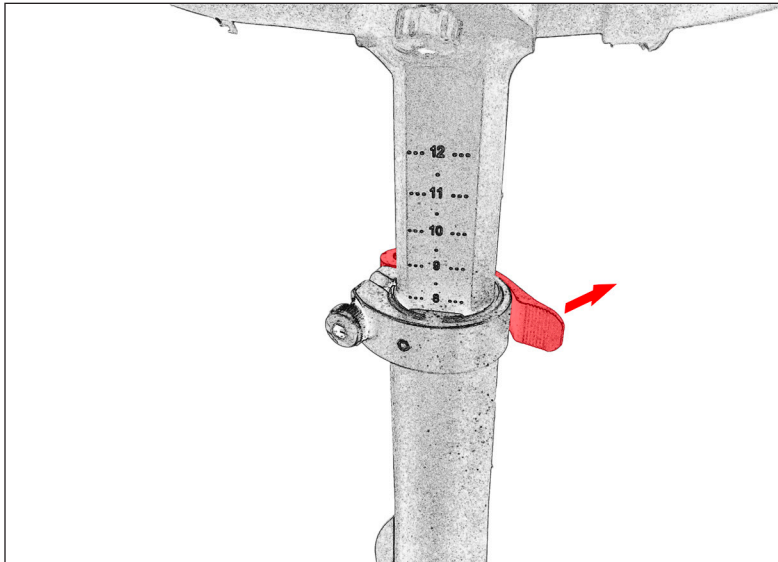

Step 1: Unlock the Clamp.





# 3. ADJUSTMENT

## - HANDLEBAR HEIGHT

Step 2: Adjust the handlebar to a height that you prefer.

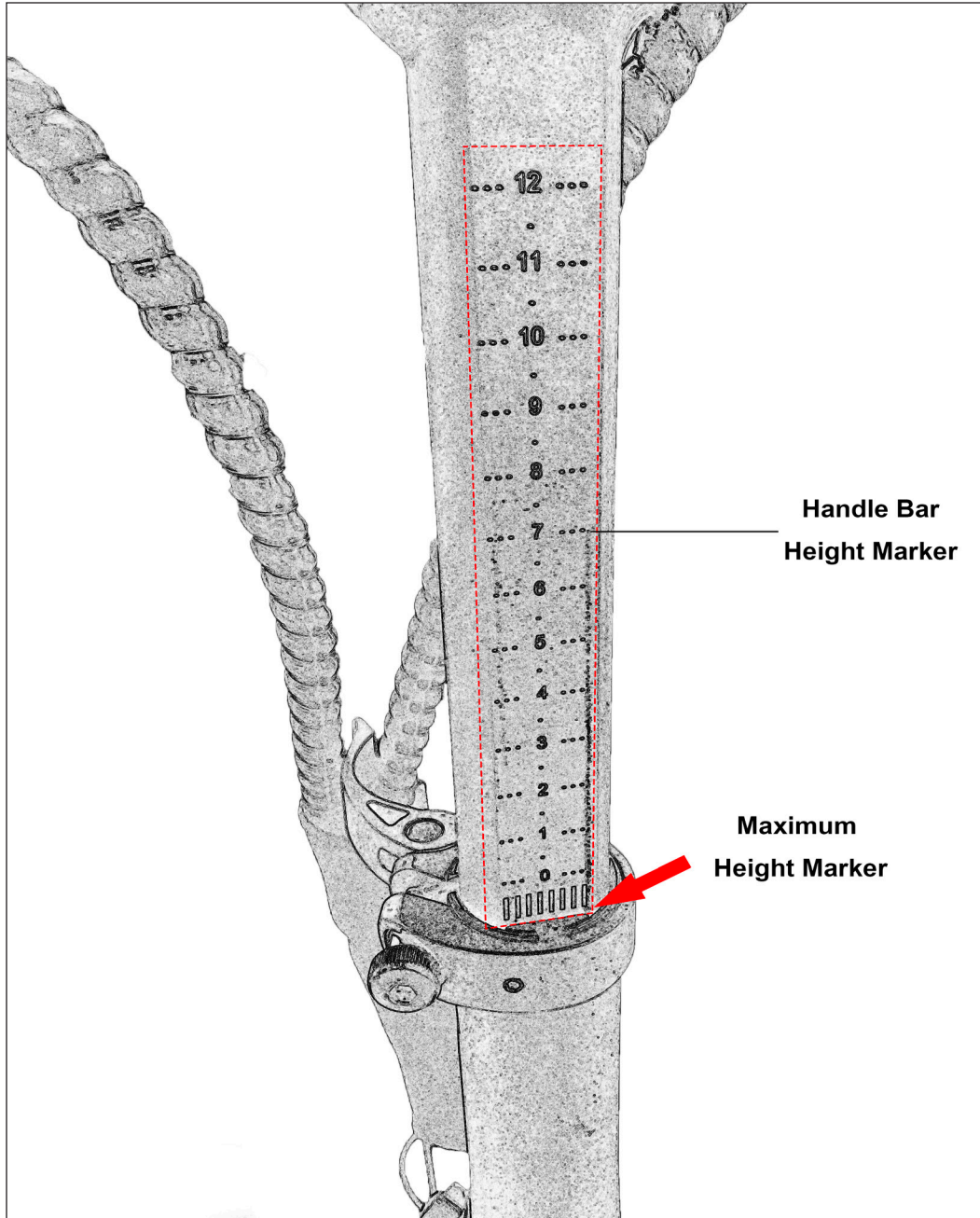

**Warning:** There is a maximum height marker on the post, you must not adjust the handlebar to a position higher than that.

# 3. ADJUSTMENT

## - HANDLEBAR TILT ANGLE

Step 1: Unlock the clamp on the top of the handlebar.

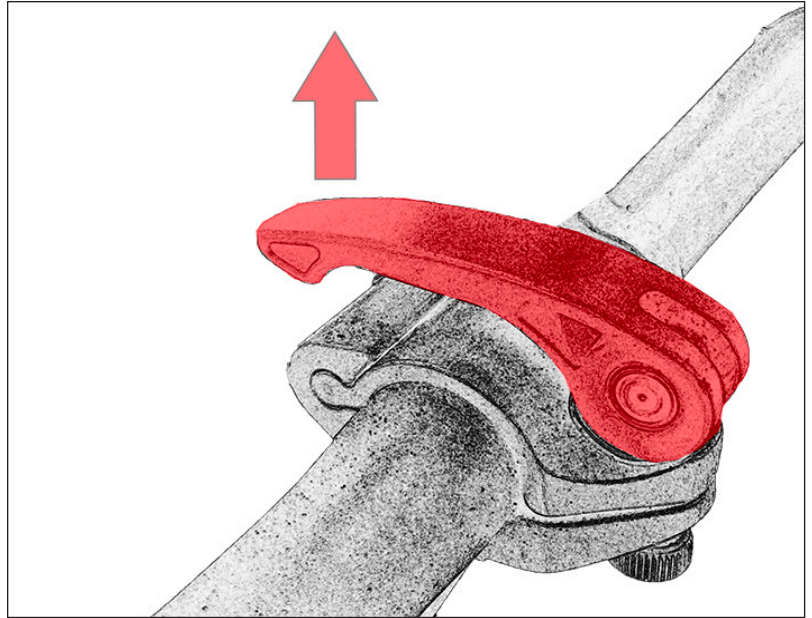

Step 2: Adjust the tilt angle of the handlebar to a position that you prefer.

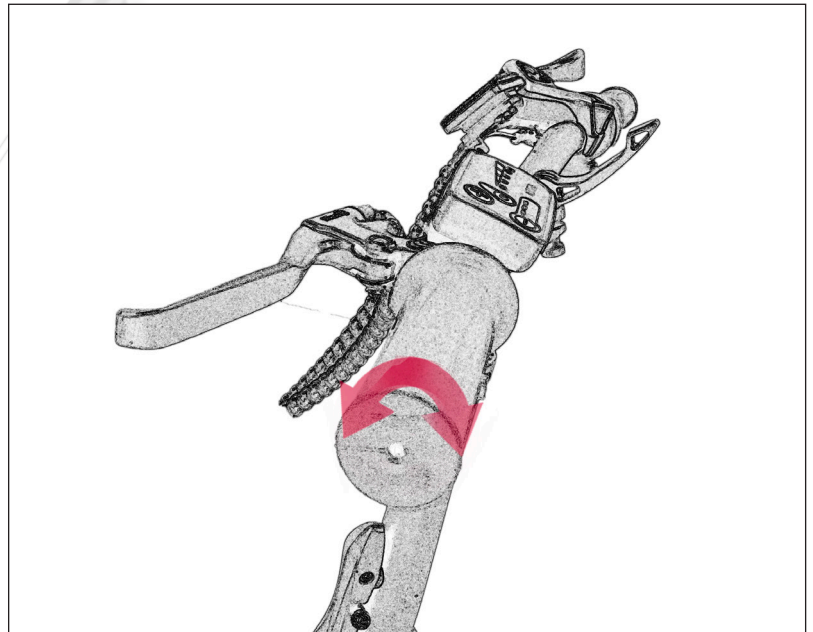

**Warning:** Please lock the clamp back after the adjustment.

# 3. ADJUSTMENT

- SEAT HEIGHT

Step 1: Unlock the seat post clamp.

**Seat Clamp:** Unlock the clamp for seat height adjustment.

**Seat Clamp Nut:** Turn the nut if the clip is too tight or too loose.

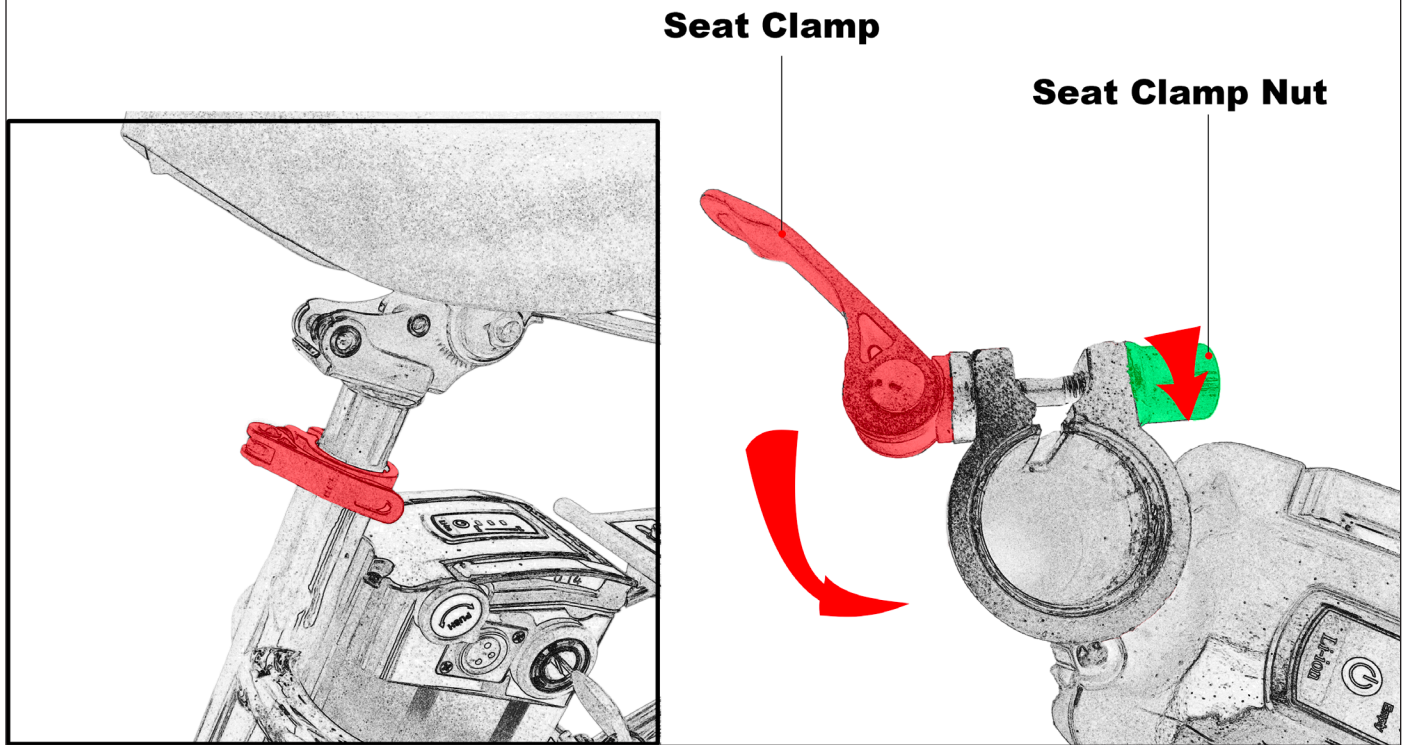



# 3. ADJUSTMENT

- SEAT HEIGHT

Step 2: Adjust the seat height to your preferred position and lock the clamp.

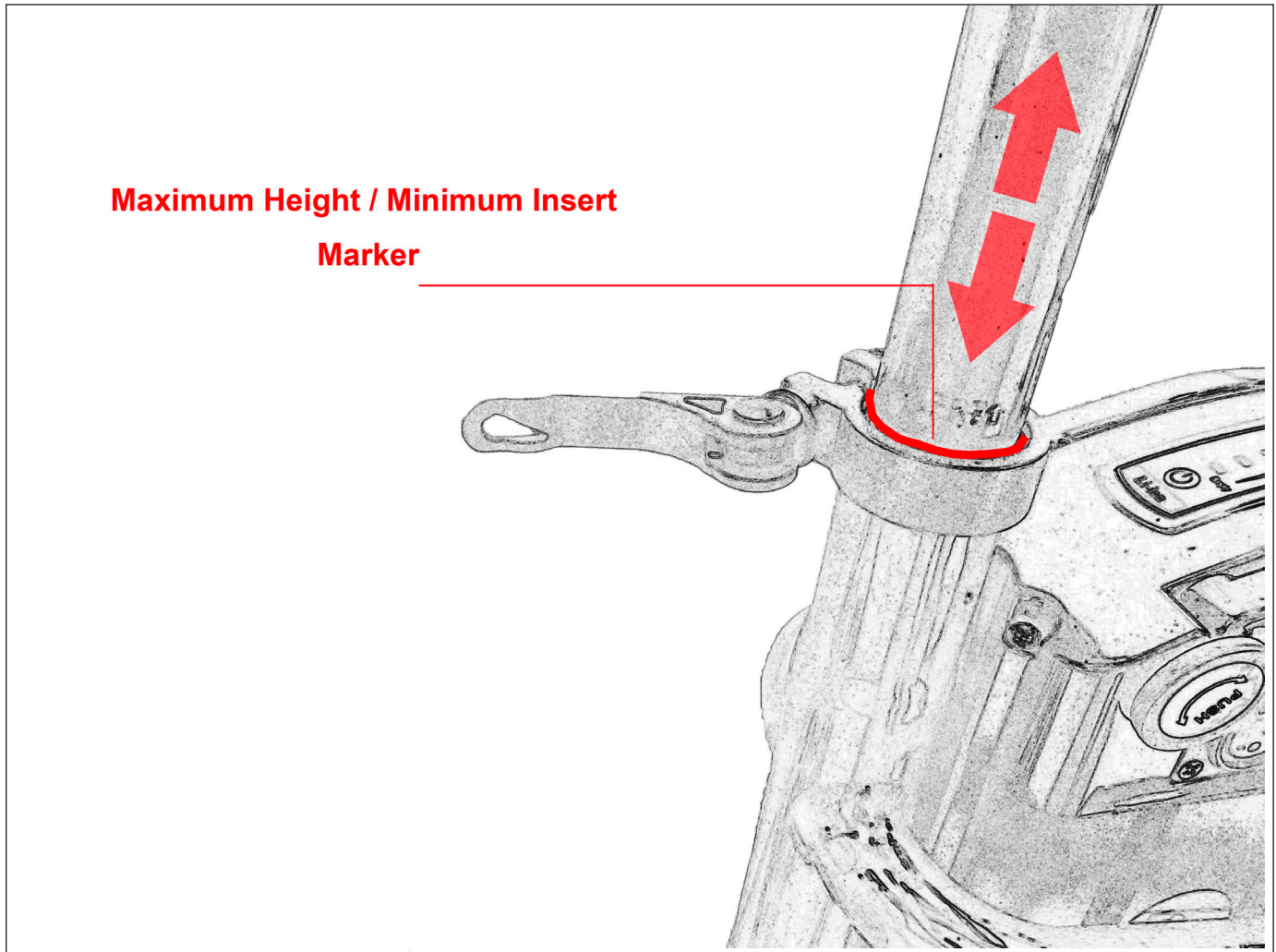

**Warning:** There is a maximum height marker on the seat post. You must not raise the seat to a higher position than that.

## 4. TURN ON THE BIKE

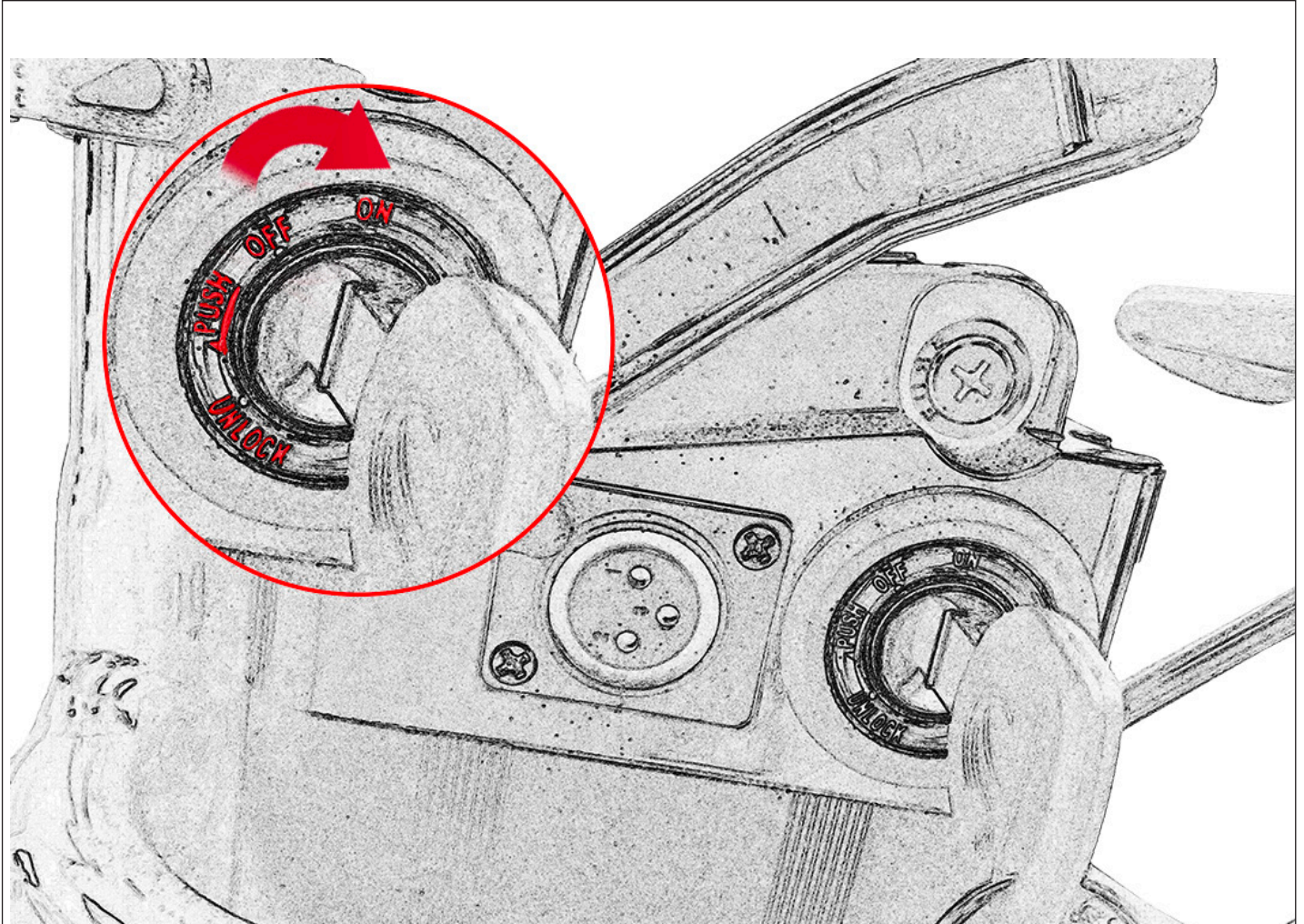

- Plug in the key.
- Turn the key clockwise to turn the bike on.

# 5. GEAR SHIFTER

Pushing the upper lever to raise the gear lever (smaller numbers).

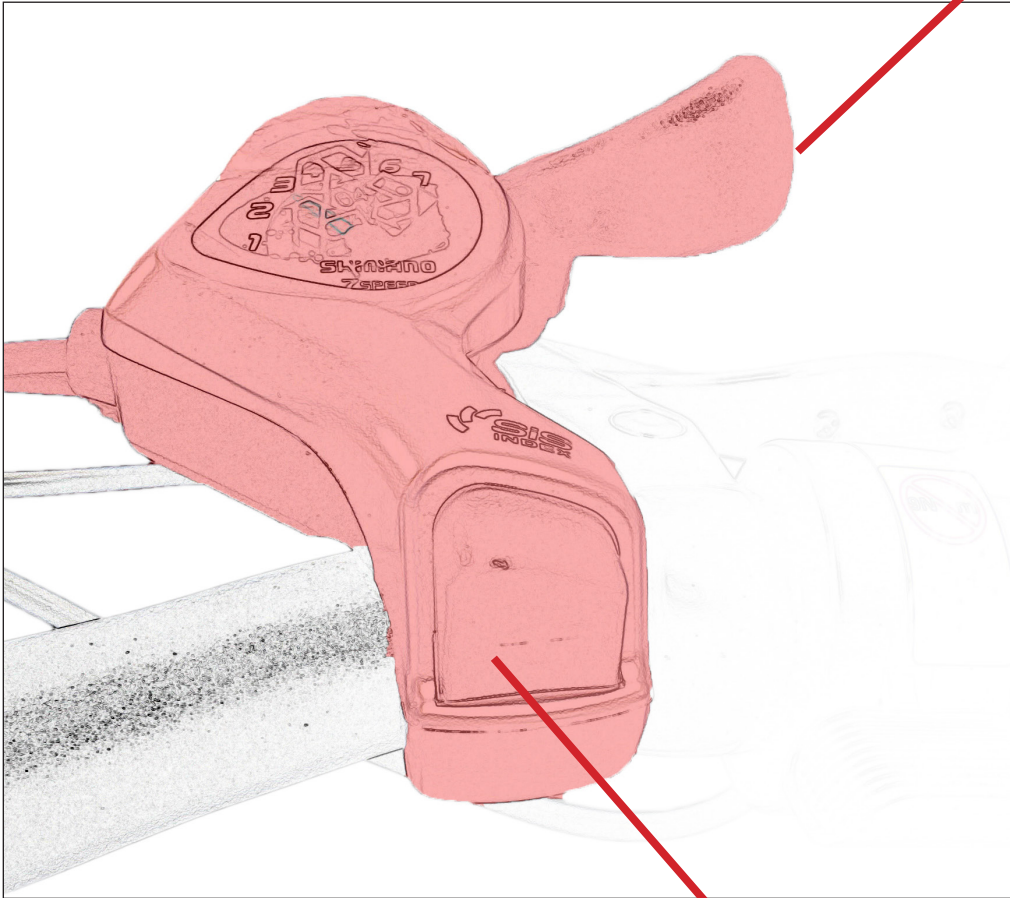

Pushing the button to lower the gear lever (bigger numbers).



## 6. THROTTLE

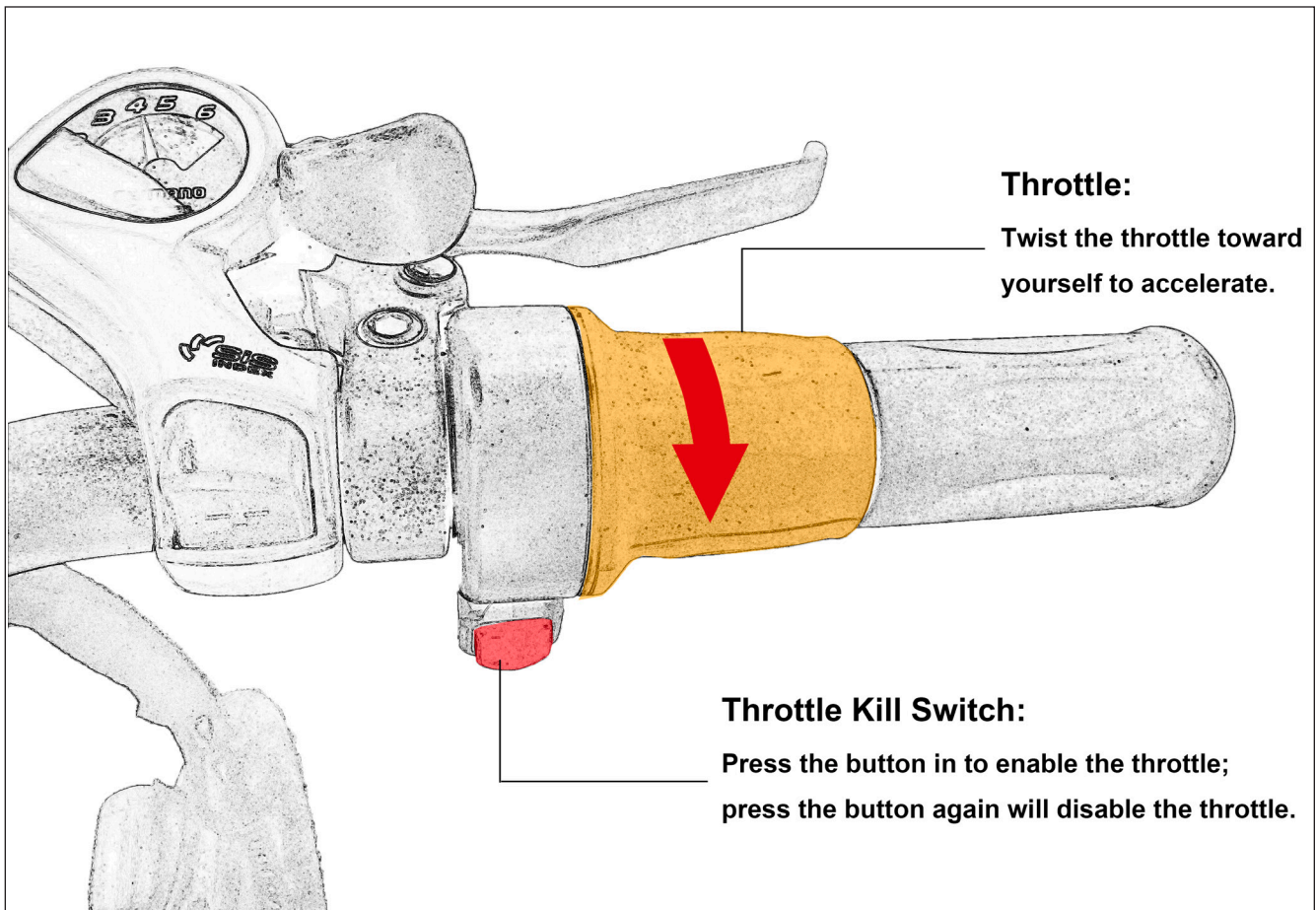

- Press the throttle kill switch to enable the throttle function.
- Twist the throttle when you are ready to go.

**Warning:** Do not turn the throttle if you are not ready to ride.

# 7. HORN

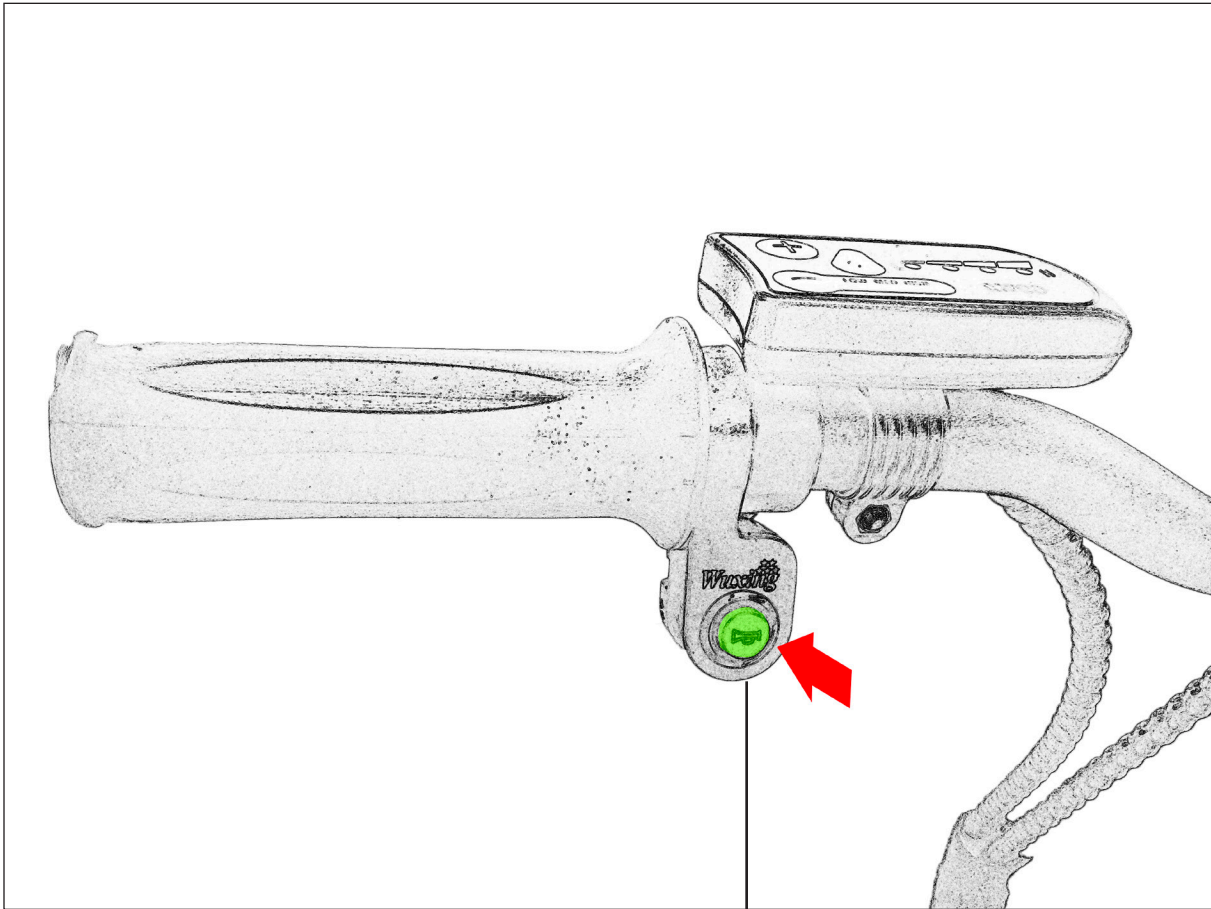

Press the button  
to sound the horn.

# 8. SAFETY INSTRUCTIONS

**To ensure the safety of you and others,**

- Do not ride after you take medications which may affect your riding ability, drink alcohol, or when you are unwell.
- Please make sure you are familiar with your local bylaw regarding e-bikes.
- Check the road conditions and weather conditions, so as to actively avoid danger.
- Wear necessary protective equipment, such as a helmet, if required by local bylaw.
- Perform a basic inspection of the bike before the ride:

**1. Battery strength:** *make sure that you have enough charge for the trip.*

**2. Tire pressure:** *on the casing side of the tire you will find the minimum and maximum pressure that applies to the tire. Insufficient tire pressure will affect the performance of your bike.*

**3. Brakes:** *check and make sure both brakes are in good working condition.*

**4. Lights/signals:** *make sure that headlight, signal lights, tail light and brake light are working well. Make sure you have a working rear reflector/tail light if you need to ride the bike at night.*

# 9. HOW TO RIDE THE BIKE

- Sit on the bike. Put on the helmet or any protective equipment required.

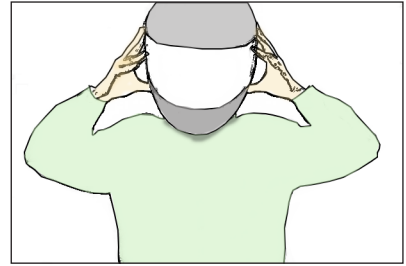

- Use the key to turn the bike on (refer to page 15).

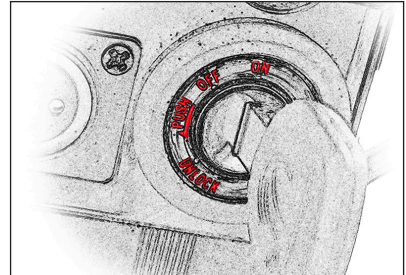

- Before you start off, kick the side stand up.

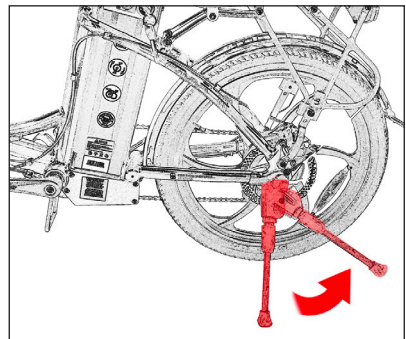

- When you are ready, start pedalling or turn the throttle. (Note: You don't have to pedal to start the bike.)



# 10. HOW TO CHARGE

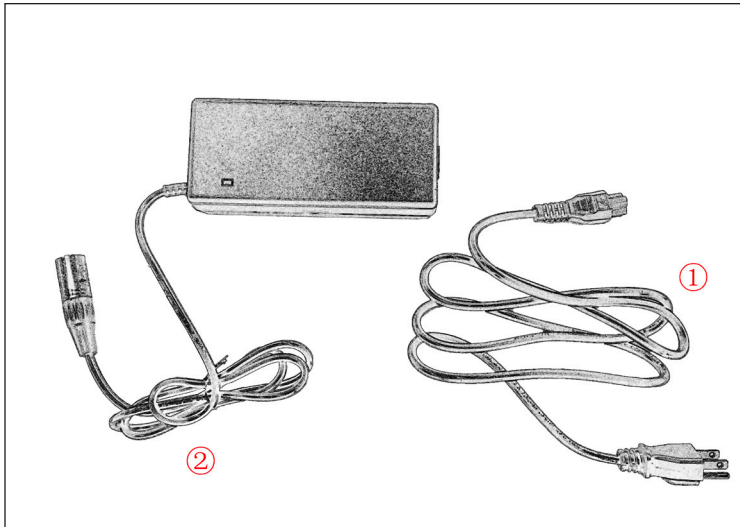

The charger is separated into two different parts:

1. A cable with one end that goes into a 110V power outlet, and the other end that goes into the charger box itself.

2. The charger box with a cable that plugs into the bike.

- **Step 1:** Take the cable from the charger box and plug it into the charging port on the battery.



- **Step 2:** Plug the the charger into a regular 110V outlet.

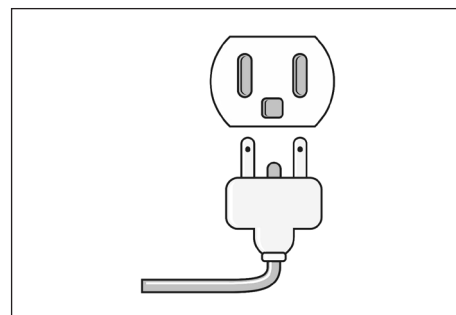



# 10. HOW TO CHARGE

- **Step 3:** Make sure the indicator on the charger turns red.
- **Step 4:** Once the battery is fully charged, unplug the charger from the power outlet first and then unplug the charger from the battery.

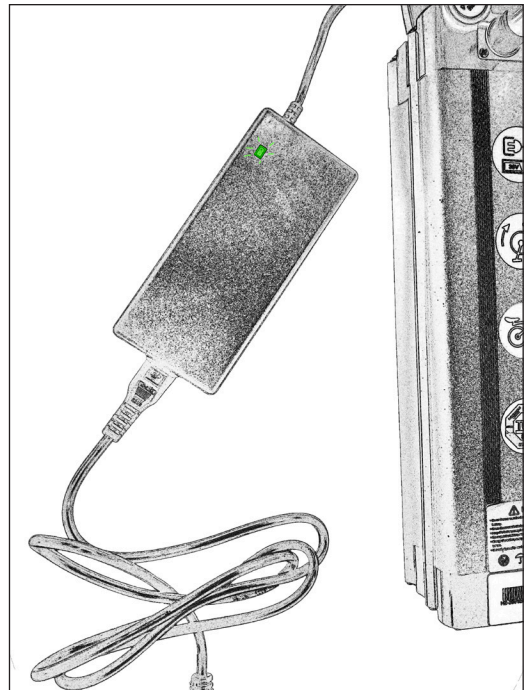
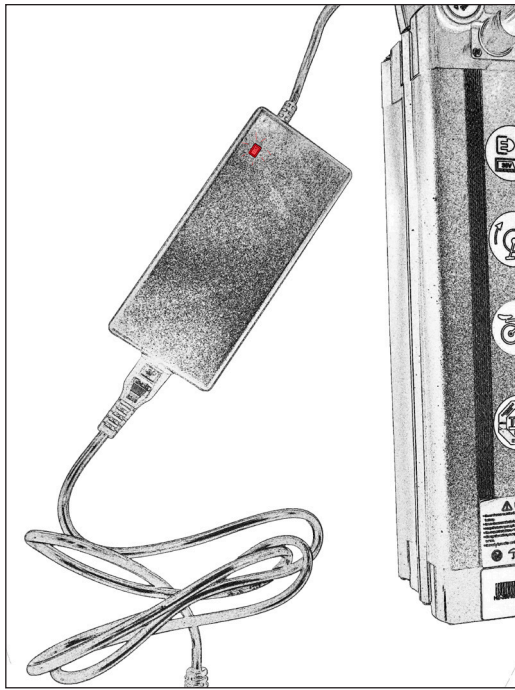

*\*The red indicator means it is charging, and the green indicator means the battery is fully charged.*

**Warning:** Do not charge the battery for more than 8 hours. If you have any concern, please contact your local dealer for assistance

# 11. HOW TO REMOVE THE BATTERY

- **Step 1:** Pull up the lever under the seat cushion.

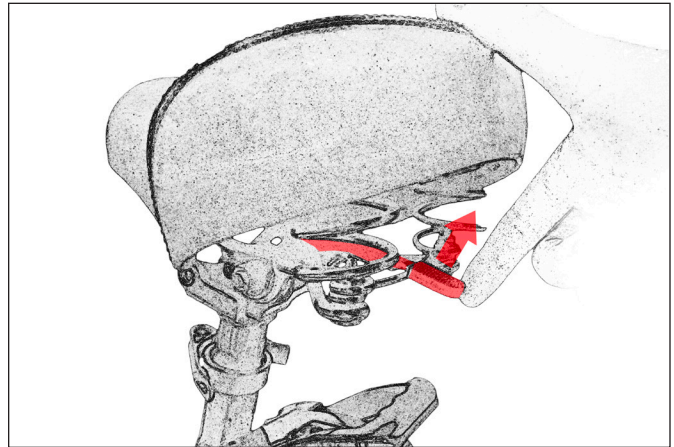

- **Step 2:** Fold the seat cushion up.

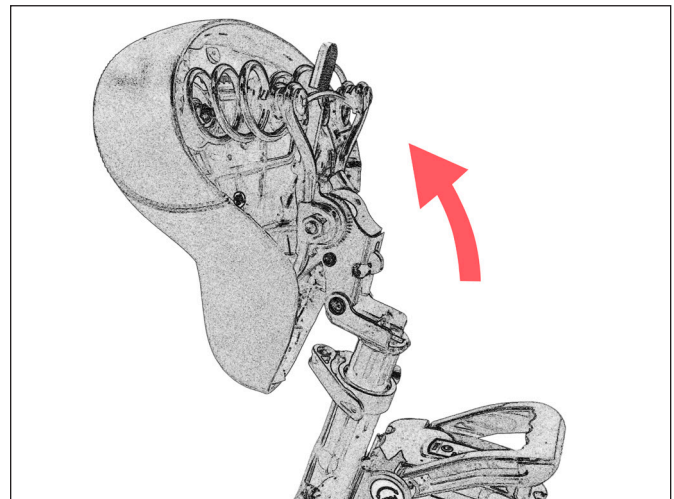

# 11. HOW TO REMOVE THE BATTERY

- **Step 3:** Plug in the key, follow the instructions on the lock - gently push the key in and turn the key to UNLOCK position.

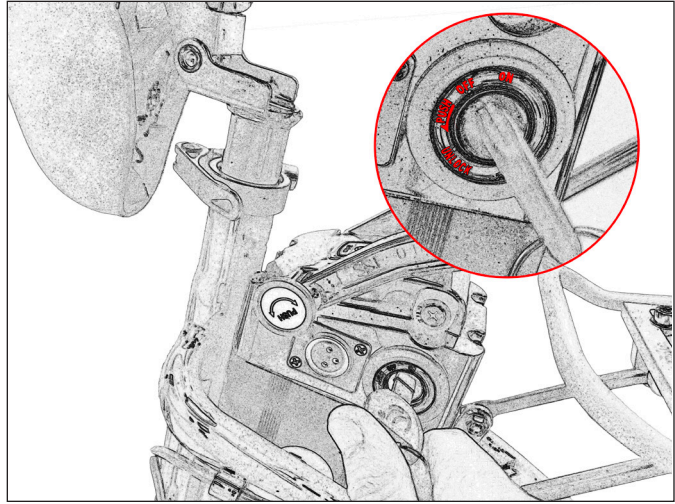

- **Step 4:** Once unlocked, the shackle on the back of the battery lock will be drawn back.

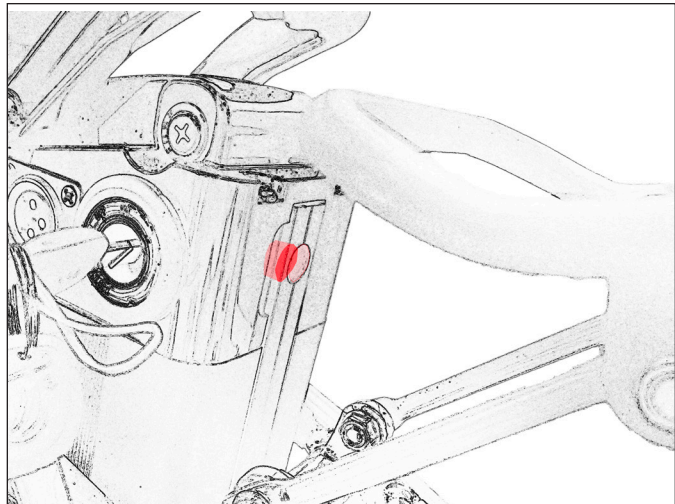

# 11. HOW TO REMOVE THE BATTERY

- **Step 5:** Lift the battery up and remove it carefully.

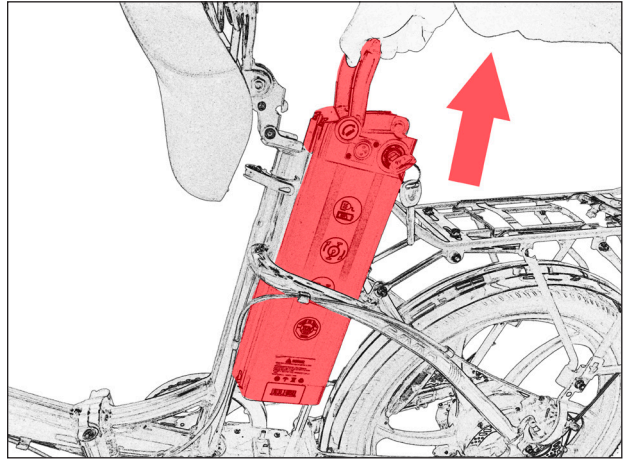

## TIP:

When putting the battery back to the bike, make sure the battery goes along the battery rail, as shown below. Once the battery is put in place, lock the battery before you want to turn on the bike.

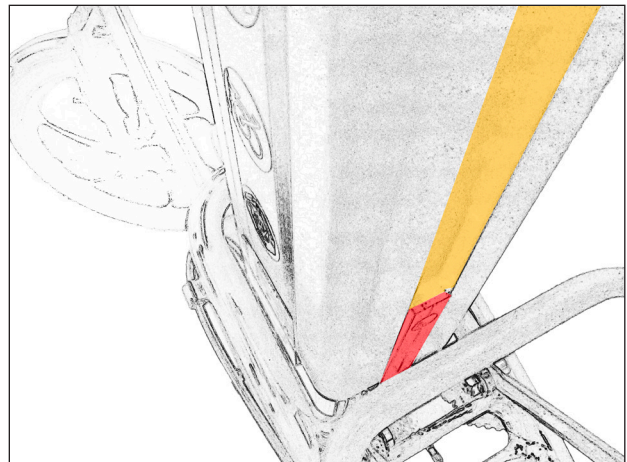



# 12. HOW TO FOLD THE BIKE

- *Main Frame*

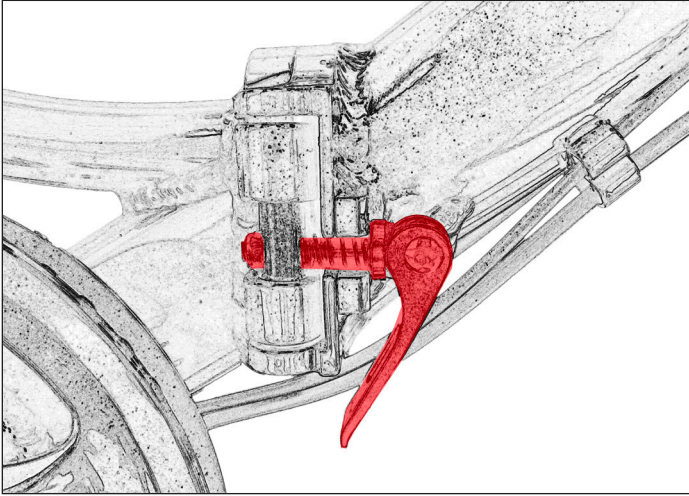

- **Step 1:** Pull up the clamp lever.

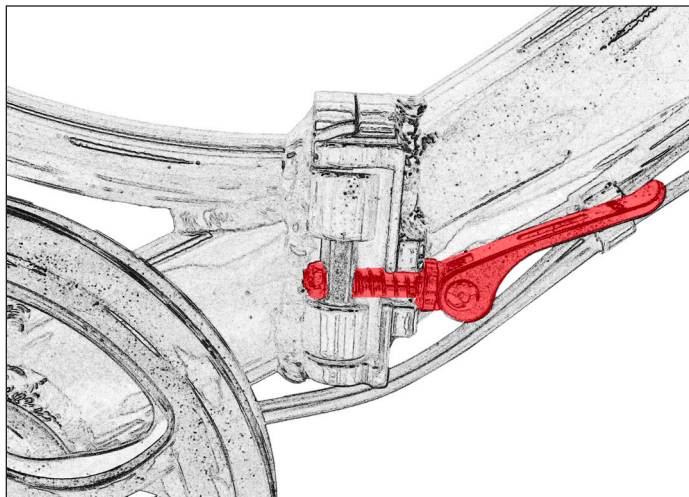
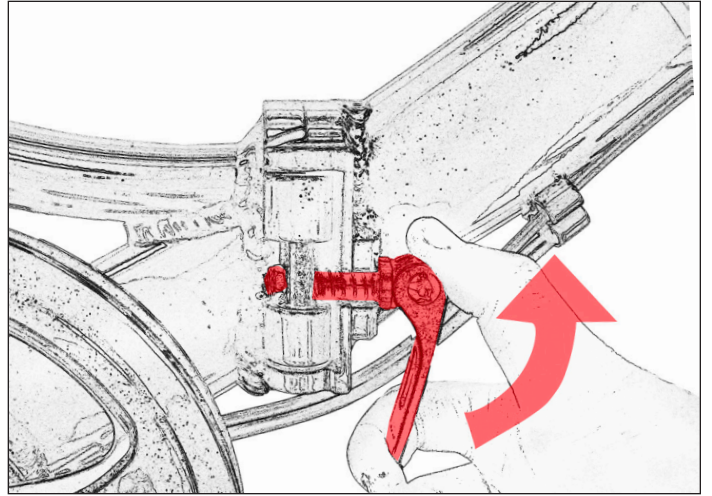

- **Step 2:** Pull out the clamp from the frame.

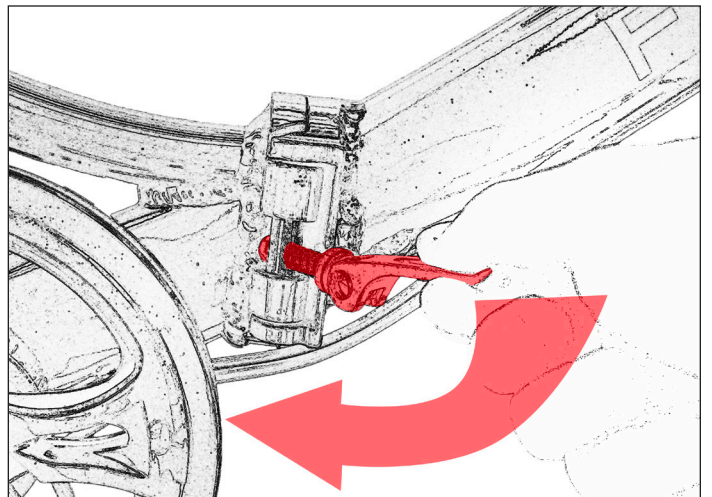

# 12. HOW TO FOLD THE BIKE

- *Main Frame*

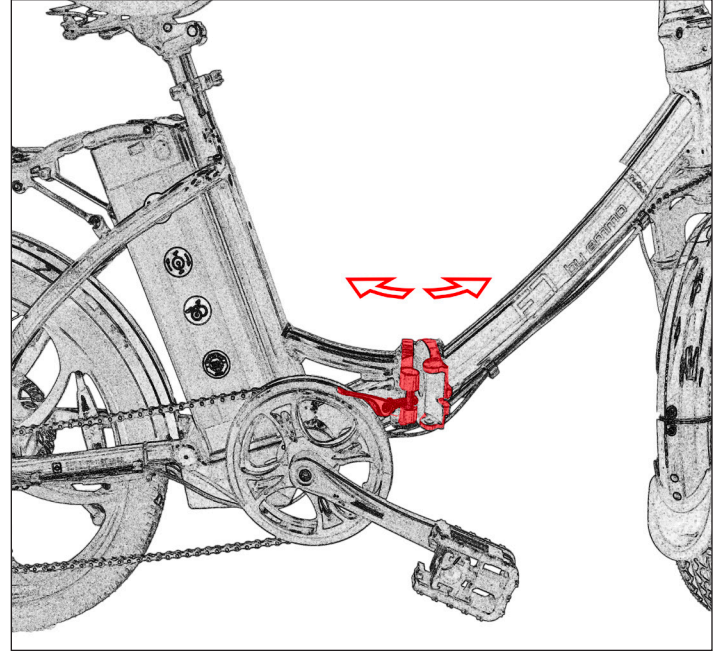
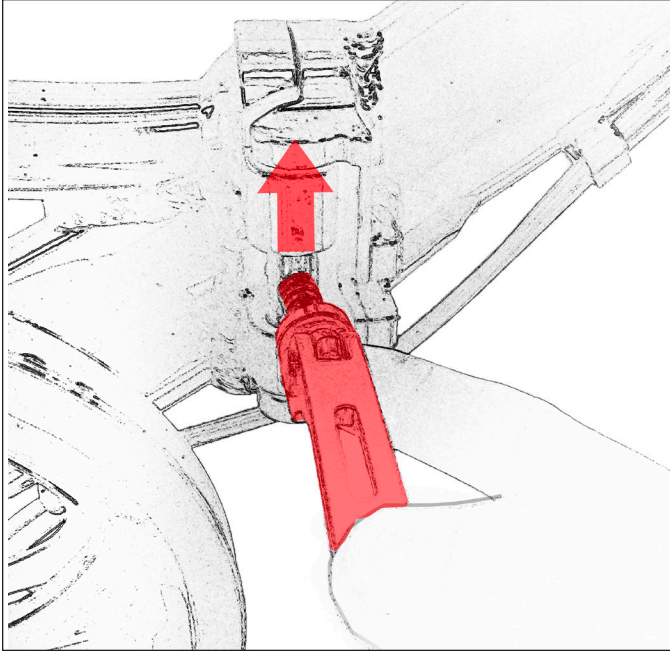

- **Step 3:** Slightly lift the clamp up to unlock the frame. After that, you will be able to fold the main frame in half.

# 12. HOW TO FOLD THE BIKE

- Handlebar

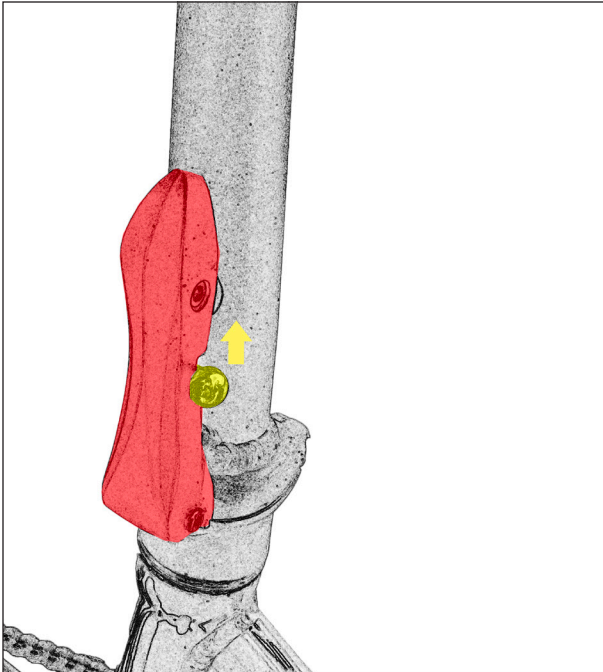

- **Step 4:** Lift up the locking nut to unlock the clamp lever.

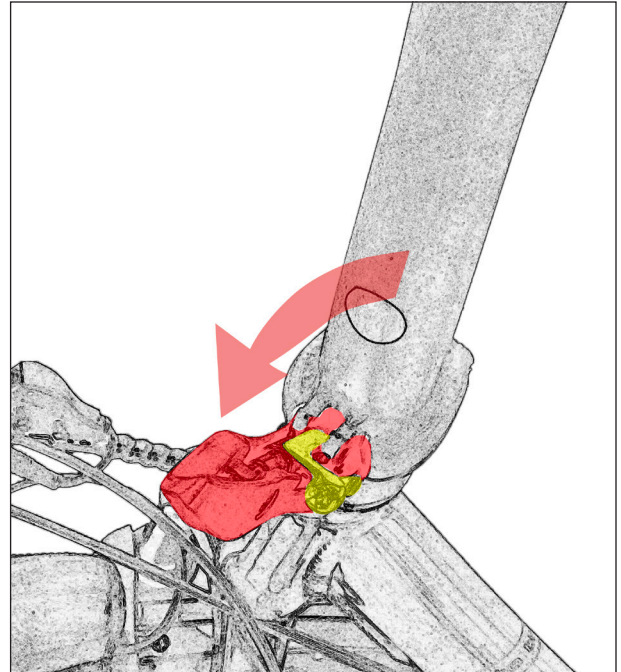

- **Step 5:** Pull the clamp lever down.

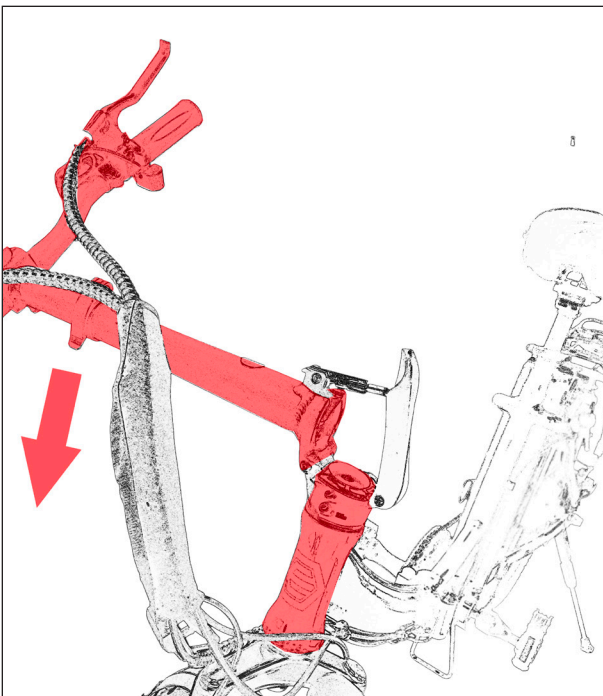

- **Step 6:** Fold the handlebar in half.



## 12. HOW TO FOLD THE BIKE

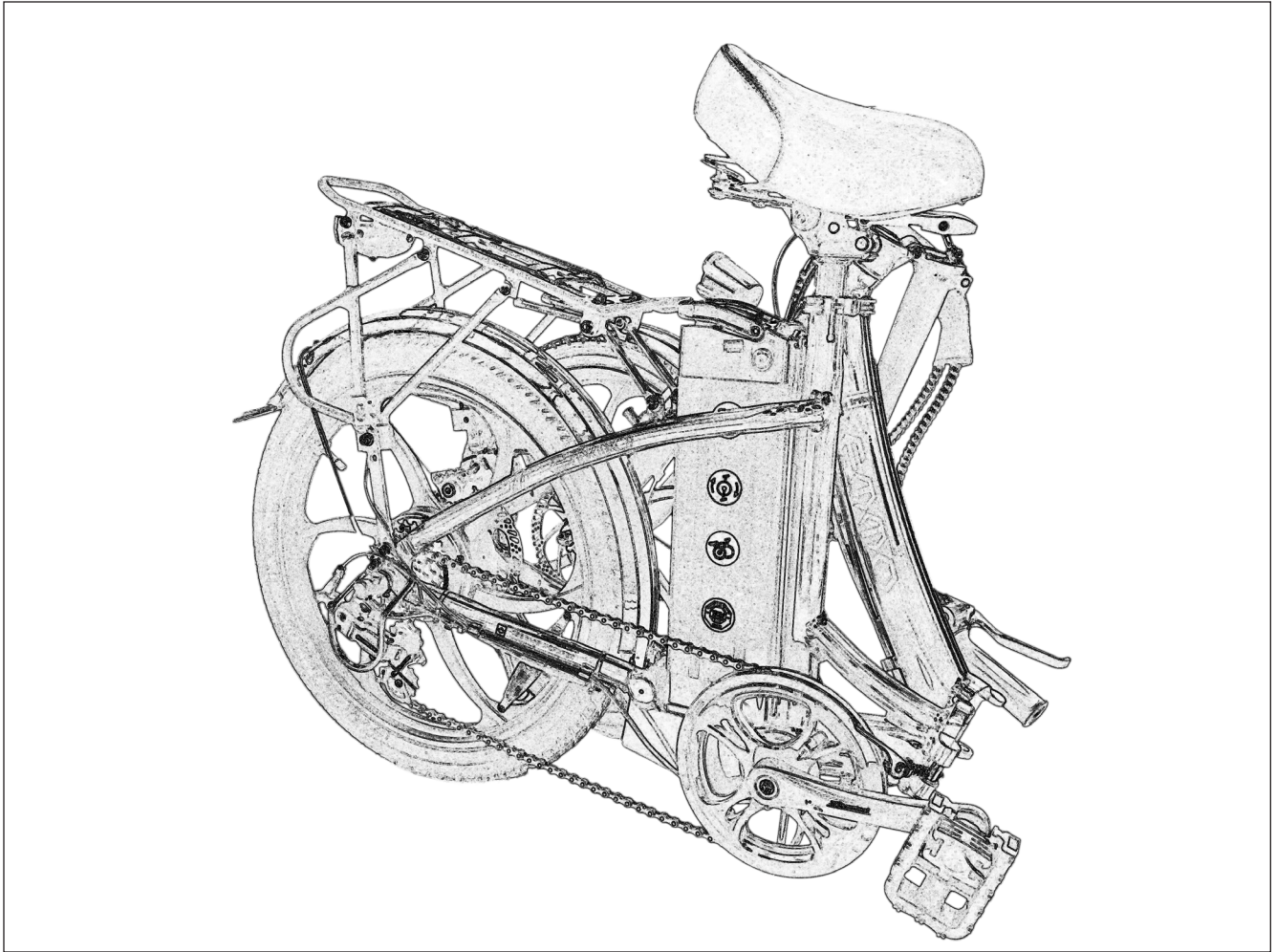

**TIP:**

After properly folded, the bike can fit into a rear trunk or stand by itself.

**Warning:** When unfold the bike back, please make sure the two clamps are locked properly.



# 13. MAINTENANCE

*Regular maintenance is required to keep the bike in its best working conditions.*

## CLEAN

Please use clean water and neutral detergent to clean the bike. Use soft cloths or sponges to clean the surfaces. Please do not use metal brushes, sandpaper or any other abrasive material to avoid scratches or even physical damages. Dry the bike with soft cloths. Please clean and grease the chain and sprockets.

### **Warning:**

- Please turn off the circuit breaker and remove the battery (if applicable) before cleaning the bike.
- Please do not power wash the e-bike.

## STORAGE

In case of storage of more than one month, such as winter storage, **Please charge the battery regularly (at least once a month) and turn off the circuit breaker.** The bike, including the battery and charger, is suggested to be stored in clean, dry ventilated place. Please do not leave the battery outside under freezing temperature. Please avoid any corrosive material or heat source.

## REGULAR INSPECTION

For **every 3000km** you travel or every **6 months**, a full inspection/tune-up is recommended based on the condition of the bike.

# E-Bike Registration

## E-Bike Registration

Once you have purchased an Emmo E-bike, you can register your vehicle with us to validate your warranty.

In order to register your e-bike, please follow the steps listed below:

1. Fill out the following form:

Invoice Number: \_\_\_\_\_

Store Location: \_\_\_\_\_

Customer Name: \_\_\_\_\_

Address: \_\_\_\_\_

Phone Number: \_\_\_\_\_

E-mail: \_\_\_\_\_

### Survey:

How did you find out about Emmo Inc.? (Please select the options that apply)

Returning Customer     Family/Friend     Passing by Store     Kijiji  
 Facebook     Google     Yelp     Other \_\_\_\_\_

2. Send the information listed above to our e-mail: [info@emmo.ca](mailto:info@emmo.ca)

3. Wait for a confirmation e-mail from Emmo Inc.