

TAUBIK

ASPECT



User Manual

SAFETY INSTRUCTIONS

Thank you for choosing and purchasing our E-Bike. For your driving safety, please read this manual carefully to ensure that you can follow the correct instructions, safety warnings and precautions before using it.

- Strictly abide by local laws and regulations and traffic laws. The company is not responsible for any consequences caused by violation of the above laws and regulations.
- Strictly follow the instructions in the manual for corresponding operations. The company is not responsible for any consequences caused by improper use, speeding, overloading etc...
- Do not use this E-Bike to do stunts, it will increase the probability of injury and damage to the E-Bike.
- Please always wear a helmet.
- Do not leave the battery near fire or heat sources.
- Please regularly check whether the brake performance is good.
- Please do not modify, repair or disassemble the product on your own.
- Avoid using used, defective and/or aftermarket batteries.
- People who should not ride the product include:
 - i. Anyone under the influence of alcohol or drugs.
 - ii. Anyone who suffers from disease that puts them at risk if they engage in strenuous physical activity.
 - iii. Anyone who has problems with balance or with motor skills that would interfere with their ability to maintain balance.
 - iv. Anyone whose weight is outside the stated limits (see Specifications).
 - v. Pregnant women.

SPECIFICATIONS

Model	ASPECT
Max Load	120KG
Motor	500W/48V
Battery	15Ah
Suspension	Front spring suspension
Max Speed	32km/h
Derailleur	Rear: Shimano 7
Max Distance	50km – 55km (Pure Power)
Max Distance	50km – 150km (Pedal assist)
Sensor	Speed Sensor
Frame	Aluminum
Brake Type	Hydraulic brakes
Tire Size	20" X 4.0"
Tire Pressure	Min: 5 psi Max:30 psi
Charger	54.6V/2A
Charge Time	6-8 hours
Fork	Suspension fork
Net Weight	31.9kg

PARTS DIAGRAMS



Features & Parts

- 1. Brake light
- 2. Battery Pack
- 3. Seat
- 4. Brake Lever
- 5. Headlight
- 6. 20 inch Tire
- 7. Rear Derailleur
- 8. Kickstand
- 9. Pedal

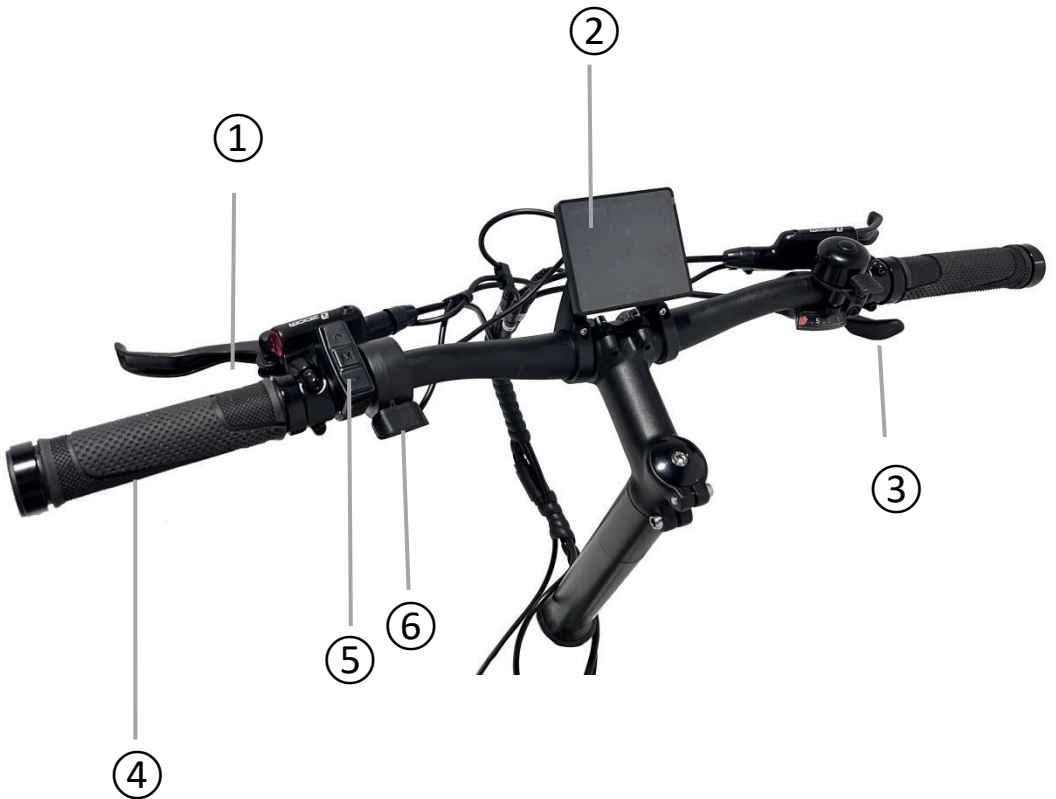

1. Left Brake Lever for front brake
2. LCD Display
3. Right shifter for rear derailleur
4. Handlebar
5. LCD Display Button
6. Thumb Throttle

DISPLAY PANEL



- (1) Voltage Indication
- (2) Max speed
- (3) Power gear
- (4) Total distance travelled
- (5) Indicates the Battery Capacity
- (6) Average speed
- (7) Current speed
- (8) Single distance
- (9) Power output by motor
- (10) Indicates the headlight on

A. Product Introduction

1 Product name and model

Colored IPS Screen Display of electric power assist bike

Product model: DM05C

- ◇ DM05C includes two versions of UART communication and CAN BUS communication
DM05C_U corresponds to UART communication version;
DM05C_C corresponds to CAN BUS communication version.
- ◇ All DM05 products are available to add Bluetooth function in its hardware.

2 Product introduction

- Imported tempered glass, 2.5D extra hard, high transmittance
- 3.5 inch HD high brightness full viewing angles IPS LCD display
- Special screen fitting technology, great sunlight and outdoor readability Separated remote control with ergonomic design
- IP65 and up waterproof, excellent for outdoor use
- Built-in Bluetooth function, compatible with CAN-BUS and UART communication
- Service Tool function for fast firmware upgrade, parameter setting, and easy maintenance

3 Range of application

Suitable for all E-bikes that comply with EN15194 standard

4 Appearance and size

The shell material of DM05C is PC+ABS, the screen is made of imported tempered glass with beveled edge. This product is suitable to be installed on a horizontal handlebar tube size of ϕ 22.2mm, ϕ 25.4mm, and ϕ 31.8mm



5 Display coding rules

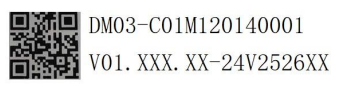

As shown in above picture:

DM05A-C01M020340001

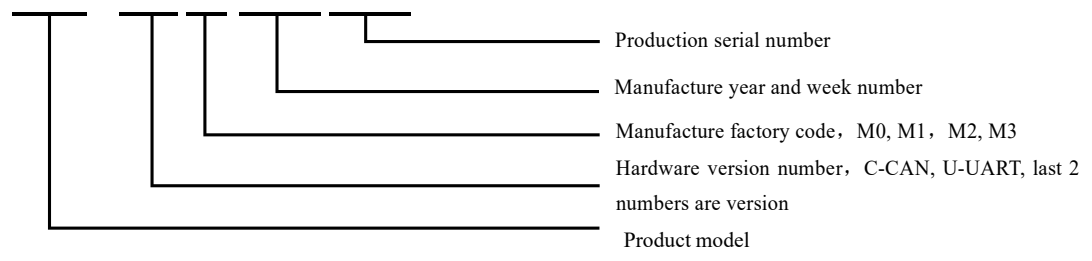

A08.01-36V2570XX

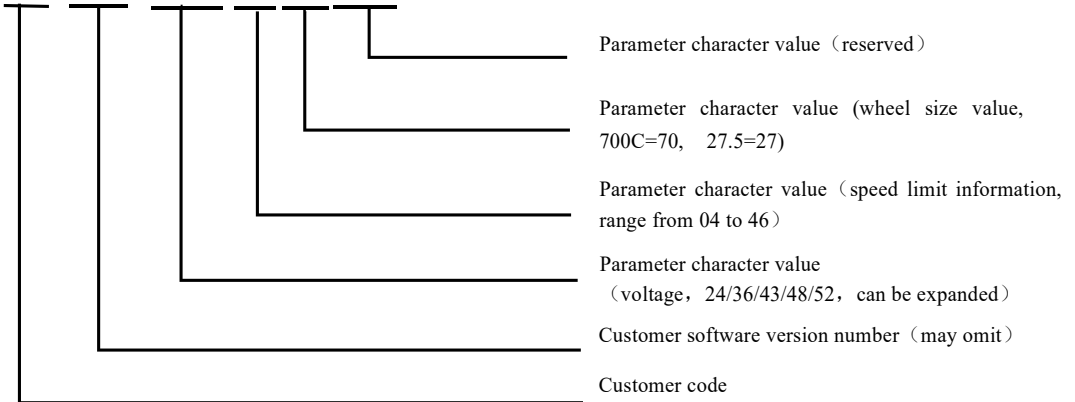

示例:

DM05C-C01M020340001

A08.01-36V2570

二 Product manual

1 Specifications

- ① Power supply: DC 24V/36V/48V
- ② Rated current: 42 mA
- ③ Shutdown leakage current: <1uA
- ④ Screen specification: 3.5 inch Colored IPS Screen Display,resolution 320*480
- ⑤ Communication method: UART/CAN-BUS
- ⑥ Operating temperature: -10° C ~ 60° C
- ⑦ Storage temperature: -20° C ~ 70° C
- ⑧ Waterproof level: IP65

7. Function overview

- ① Left side independent buttons with ergonomic design

-
- ② Customization of boot interface and UI
 - ③ Unit: Km/Miles, Language: English/German
 - ④ Display key riding data, speed, mileage, battery info, etc.
 - ⑤ Statistical function for power assist mode
 - ⑥ Walk assist function
 - ⑦ Error code indication
 - ⑧ Parameters setting and advanced setting
 - ⑨ Range and battery indication (*available if BMS provides necessary info)
 - ⑩ Percentage Analysis of total power output shared between engine and rider (*available if torque sensor provides necessary info)
 - ⑪ Health info statistics (*available if connected to external bluetooth device)
 - ⑫ *Optional: Bluetooth function, for wireless connection for data transmission
 - ⑬ *Optional: Service reminder function
 - ⑭ *Optional: Auto headlight on/off function
 - ⑮ *Optional: Real-Time Clock, for a current time indication

8. Installation

- ① Display locking clip includes two handle bar sizes, size A $\Phi 31.8\text{mm}$, B $\Phi 25.4\text{mm}$. Please include the requested locking clip size in the purchase order.

Installing DM05 display: Adjust display to a position easy to operate, using M3*10 hex set to screws and tighten. Tightening torque: 0.8N.m

***Note: Damage caused by excessive torque is not covered by the warranty.**

- ② Place remote button on the left side of horizontal tube, for more remote button models, please refer to Velofox product catalog.
- ③ Connect the 5 pin plug to the docking plug of the controller

6 Interface

6.1 Boot interface

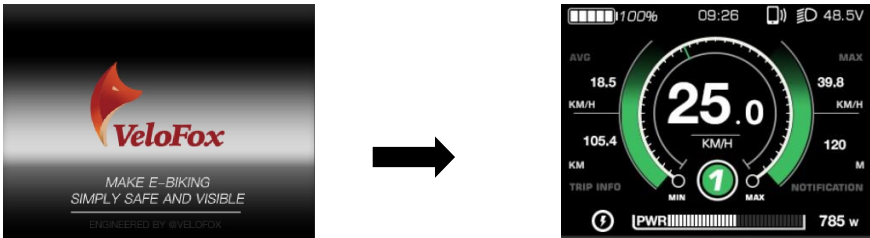

Boot logo interface is displayed for 2 seconds after the display is turned on. When the communication connection is established, display enters the main interface which shows information obtained from the controller. (All data displayed is following communication protocol provided by the customer) .

6.2 Basic interface and operation



- ① All RM series buttons are compatible with DM02 series displays, the power-on button is located on the top side of the display.
- ② Standard Outlet is a board end connector, which is convenient for after-sales maintenance and replacement.
- ③ 3.5 inch HD high brightness IPS LCD screen meets the need for customization of the boot interface and UI interface

6.3 Function interface introduction

Boot interface and basic function interface

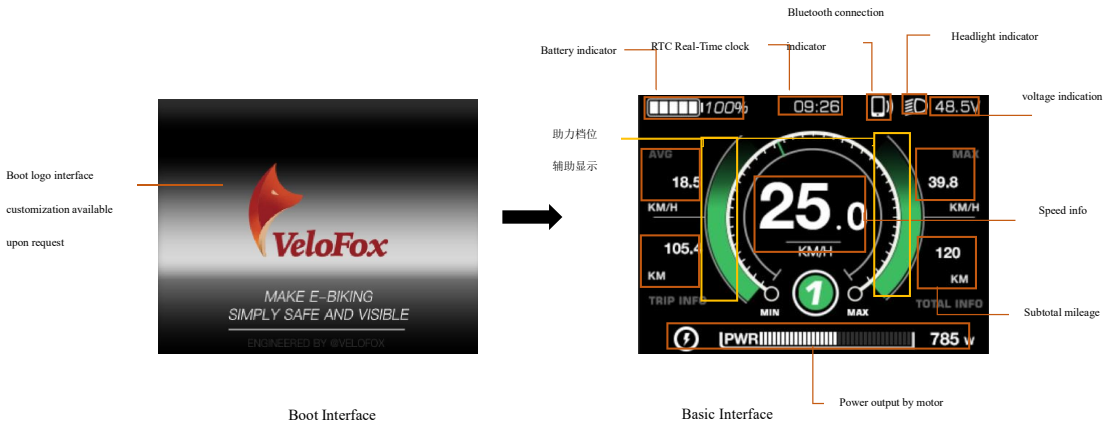

Boot logo interface is displayed for 3 seconds after display is turned on. When the communication connection is established, display enters the main interface, showing real-time information stored in the controller and battery BMS according to the communication protocol. (Battery indicator will not show battery percentage if BMS info is not available)

The basic function interface contains real-time speed, power information, power gear, clock information, light indicator, connection status and cycling statistics display.

Mileage statistics show speed and mileage information, including average speed, maximum speed, and TRIP info which is subtotal mileages as shown on basic interface. Speed display value has 3 digits, maximum value is 99.9KM/H, including one digit after the decimal point. Subtotal mileage

TRIP value has 4 digits, including one digit after the decimal point. After 9999.9 KM is exceeded, the decimal point is not indicated, and a 5-digit mileage value is displayed directly, with a maximum value of 99999km. After the maximum value is exceeded, the value is shown as the actual mileage value deducted by 100,000.

Cycling statistics in the basic function interface can be displayed in the main interface, and the data can be cleared by pressing the button. During data clearing, only TRIP related information is cleared, but ODO accumulated mileage information is not cleared.

Other function interfaces

Function interface I-battery information,

The function interface II mainly displays battery information, including voltage, capacity percentage, accumulated charging cycles, and Range which is endurance mileage. Accumulated charging cycles are provided by battery BMS, if it is not available from BMS, display shows ---- for charging cycles. The Range is calculated by controller using battery BMS capacity info, if controller can not provide range info, range info shows----.

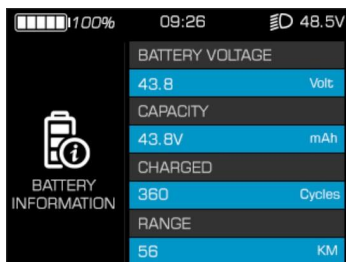

Function interface II——Motor information

Function interface II shows the motor information of the system. The function needs the support of the controller.

Power analysis area shows power output analysis, including average power output by motor, the maximum output by motor, and power output shared between rider and motor. Power output by motor will follow data provided by controller, if requested info is not available from controller, display will calculate using collected voltage and electric currents data.

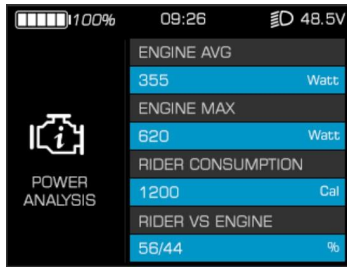

Function interfaceⅢ——Assist Mode Usage Statistics

The function interface Ⅲ mainly displays the usage time statistics of different power assist modes during the riding process. The statistical data is calculated by the meter according to the actual riding state and displayed as percentage data. The statistics of the usage time of the power-assist mode can be reset to zero by pressing the button.

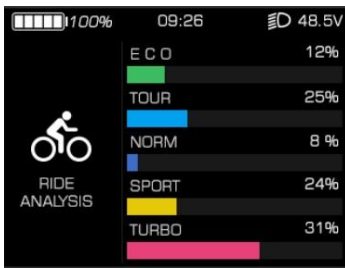

PAS 英文档位

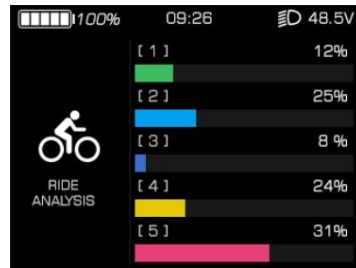

PAS 数字档位

In the state of the basic function interface, short press the M key to switch the display of each function interface.

Walk assist interface

Long press  to enter walk assist mode, interface shown as below:



Maintenance reminder interface

The display can be set with regular maintenance reminders, and when reaches the set mileage value, display will notify the user through the maintenance reminders. After the maintenance reminder mileage is reached, display will show a notification interface every time being turned on to prompt the user to carry out daily vehicle maintenance. Notification interface can be cancelled by short press M button manually. After connecting to service tool box, the maintenance reminder can be reset through after-sales diagnostic tool, and meanwhile, the maintenance record will be registered.



Error code interface

When the display receives the error info returned by controller, it will show a detailed error code on interface, indicating relevant electrical system fault information. The error code will be displayed numerically in the speed display area.



Bluetooth connection and message alert interface

The instrument supports Bluetooth function. After bluetooth connection is successful, the icon  will be displayed in the upper left corner of the instrument.



Setting interface

Within 10s after turning on display, long press M button to enter the setting interface, short press \wedge 、 \vee to switch between setting interfaces. Short press \wedge 、 \vee to enter parameter picking state.

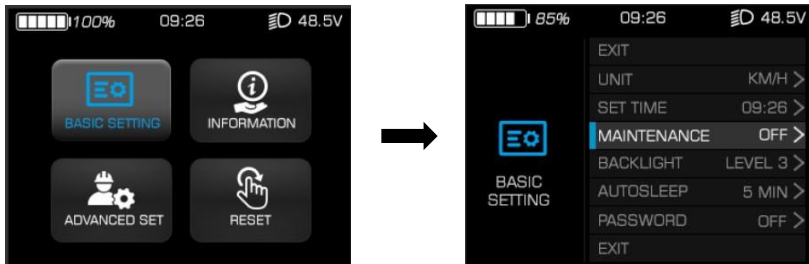

设置界面 1 级菜单页面

For more setting operation illustration, please refer to part 7

5 Button definition

5.1 Button name



Power button: Turn on/off the display

Adjust button: Adjust the assisting power level during riding and switch functions

Long press the adjust buttons to perform specific function operation



Mode button: Switch interface functions and enter into parameter setting interface

5.2 Definition of button operation

Operati on	Description
Short press	Press the button and soon released, while the button is released,the function activated accordingly
Long press	Press the button and hold, when the hold time exceeds the setting time(generally 2 seconds), the function activated accordingly.

4 Basic function operation

4.1 Turn on/off the display

To turn on, long press  button until boot logo interface appears and shortly enters the basic interface. To turn off, long press  button until display is turned off. If the rider does not perform any operation on the display within set shutdown time, while speed is 0, and current is less than 1A, then the display will be turned off automatically. Set shutdown time is self-defined by user.

4.2 Assist level switch

During normal working state, short press 、 buttons to switch assist level, and change assist mode

* Power display has two default modes, English gear and digital gear; You can specify the requirements in the order, or modify and select by yourself through the advanced Settings and auxiliary tools of the instrument .

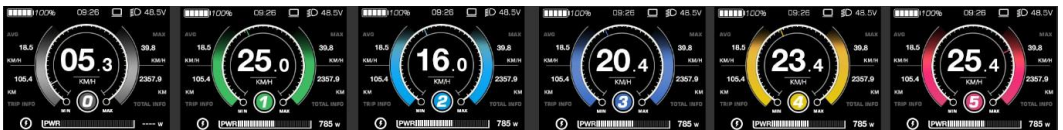

Power assist display modes as shown below:

Digital gear: 0-5 levels

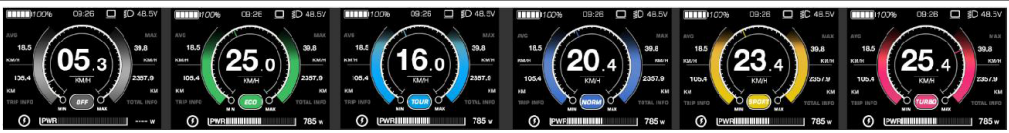

English gear:



Short press  button to switch assist level. Switching level is not cycled, that is, after reaching 5th level, short press  button to return to off level. It's the same when adjusting up.

4.3 Information switch

In a power-on state, short press M button to switch alternately from basic interface, function interfaces.

The switching process of each interface, as shown below:



基础界面

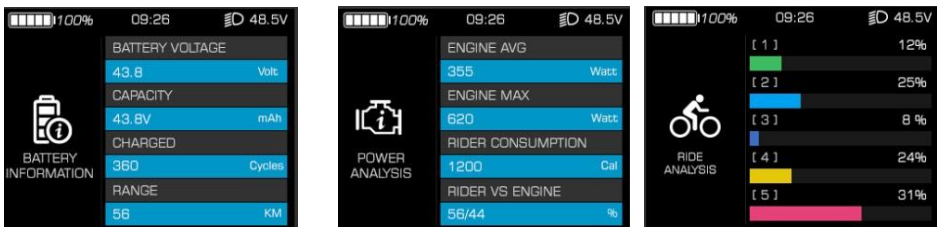



功能显示界面

4.4 Light control function

Display supports automatic lights-on/off function, when loaded with battery and is turned on, the default is to automatically turn on/off lights, that is the display automatically detects the ambient light

intensity and controls the turning on/off of the lights. The icon  on the top right corner of the basic interface indicates automatic lights-on state.

When automatic lights-on/off function fails, long press  button to manually turn on the front light, a light icon  on top left corner of screen will appear indicating light-on status. Long press  button to manually turn the lights off.

Automatic lights-on/off function is disabled , after manually turn off the headlight. Re-start display to enable automatic lights-on/off function.



When headlights are on, screen brightness will be lowered to preset brightness level.

4.5 Maintenance reminder

Display supports maintenance reminder function, when this function is enabled, the display will remind the user to give ebike a maintenance check once the total mileage reached a preset value. maintenance reminder function can be turned on/off in the setting interface and is turned on by default. The factory default reminding mileage is 5000km which is not modifiable by users, that is, display will remind the user to give a maintenance check once the total mileage reached 5000km.



4.6 Walk assist function

When speed is 0, long press  button to enter walk assist mode, motor outputs power according to the set speed and control the actual walk speed, display shows the walk assist icon  and the real-time speed. Release  button or any other button to exit walk assist mode, the motor is turned off, and the display gets back to the basic interface. Walk assist interface, shown as below:









4.7 Battery power indicator and assist power output

Battery power information is divided into battery bar indication and remaining percentage indication. When battery power is normal, battery capacity is divided into 5 bars. Before communication is established, the battery percentage is not displayed, and the power bar is full and blinks at 2Hz. After battery info is acquired, power bar will stop blinking, and displays the power percentage. If communication is not successful within 3s, it will stop blinking and no power percentage will be displayed.

After battery capacity is lower than 5% or the voltage is lower than low voltage value, display will enter the low-voltage mode. In this mode battery level showed level 0 and border blink at 1Hz, with no power output from the motor, and disabled assist level switch. Power assist level is displayed as OFF or 0.

To get out of low-voltage mode, reset, and increase the voltage above low-voltage value and battery capacity above 5%.

Percentage of battery power and power level table (Battery % info is required from BMS or controller) :

余量百分比信息	电池条指示	说明
$80\% \leq \text{SOC}$		Full battery level 5
$60\% \leq \text{SOC} < 80\%$		Level 4
$40\% \leq \text{SOC} < 60\%$		Level 3
$20\% \leq \text{SOC} < 40\%$		Level 2
$10\% \leq \text{SOC} < 20\%$		Level 1
$5\% \leq \text{SOC} < 10\%$		Level 0
$0\% \leq \text{SOC} < 5\%$		Level 0 and icon blink at 1Hz

◇ Remarks about battery indicator:

When there is a battery communication error:

- B. Display will estimate the power according to the voltage and show the battery level accordingly;
- C. No battery percentage information will be shown;
- D. Range information will not be displayed;
- E. If the voltage is lower than the low-voltage value, the effect of the current on voltage needs to be considered when converting to a voltage at 0 current

A. Setting function

Display provides specific parameter setting functions. The optional items of setting function will be deleted according to different market and product standards. The following is the complete parameter setting, information reading function description under the default state of display. Please contact our sales and technical support team for confirmation in case of any discrepancies.

Within 10s after turning on display, long press M button to enter setting interface, short press ,



✓ button to switch between setting interfaces. In any setting interfaces, short press M button to enter parameter editing state, the blue mark indicates chosen parameter, and selected option or value will be indicated by a white font with a grey background. Short press ^、✓ button to edit parameters. Long press M button to confirm parameter selection. Long press M button again to exit and return to previous page

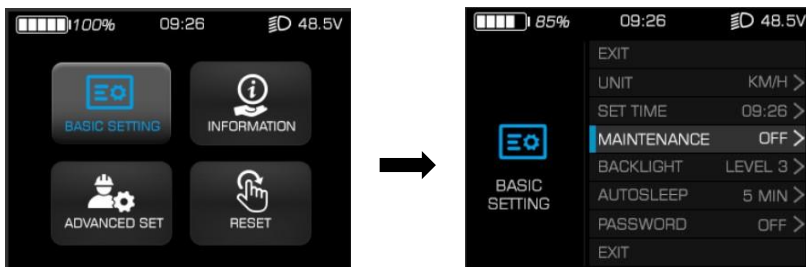



Selected option or value will be indicated by a white font with grey background, as shown below:

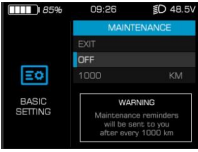

In any setting interfaces, short press M button to enter the next level menu, and long press M button to return to the previous level menu.

First level parameter setting interface, and the description of each parameter interface is as follow:

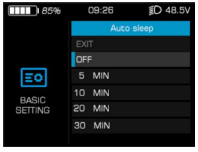
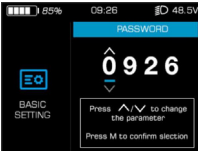
Setting	Interface	Description	Setting data	Remark
Unit setting		UNIT	Value=KM/H MPH	Default Value=KM/H Metric MPH
Clock setting		SET TIME	Customization	Default= 12 : 00

Maintenance reminder		MAINTENANCE	Fixed value	Default=5000km
Backlight level setting		BACK LIGHT	Value= LEVEL1, backlight level 60% Value= LEVEL ^ backlight 80% Value= LEVEL backlight level 100%	Default Value= LEVEL 3
Auto shutdown		Auto sleep	Value=OFF, 5-30 min	Default Value=5 min OFF means no auto
Power on Password setting		Password	Value= OFF and ON. When is ON, is allowed to 4-digit	Default value: OFF
Display info		Display information	read only	According to communication protocol
Battery info		Battery information	read only	According to communication

Controller info		Controller information	read only	According to communica tion
--------------------	---	---------------------------	-----------	--------------------------------------



B. Advanced setting functions

***Warning**

The advanced setting function is based on specific protocol content, allowing to modify and set the controller and system parameter through display side. This feature is only available to specific groups of people, such as bike manufacturers, dealers and other entities with professional technical capabilities. Debugging and maintenance are allowed through advanced setting functions. In case of improper parameter setting or other setting problems, the whole system will work improperly or even have failure problems. **Please be cautious about whom to open this feature to.**

Advanced settings require a specific password, if you need to use this feature, please communicate with our company sales and technical support team to confirm compatibility with your current hardware version. In the meantime, please confirm with our sales and technical support team for adequate maintenance capacity, before obtaining the password.

Advanced setting operation instructions

After selecting the advanced setting in the first-level menu, short press M button to enter the login password. Short press M button to select the corresponding password digit in the 4-digit password field. The selected password digits will be highlighted with a white background. Short press 、 to edit password value, and short press M button again to confirm the input. The password input interface is as follows:

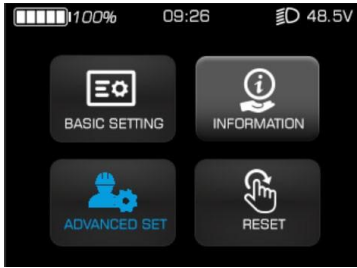



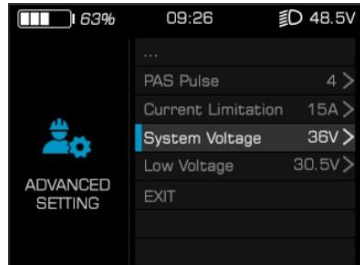
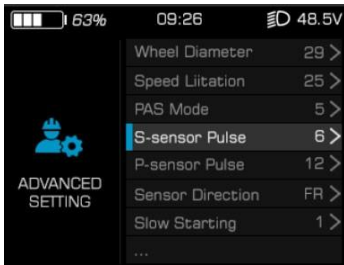

After the password is typed correctly, advanced setting is entered, divided into two-page contents. Short press \wedge 、 \vee to pick and select.

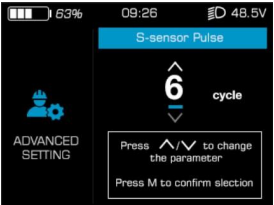
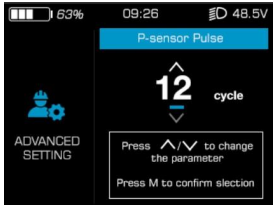

Advanced setting functions descriptions: :

Setting	Interface	Description	Setting data	Remark
Wheel size setting		WheelDI=Wheel diameter	Value=12, 14, 16, 20, 24, 26, 27, 27.5, 700C 28, *29, *CCF (*Value is optional)	Default value 26

<p>Speed limitation setting</p>		<p>SpdLtd=Speed limitation</p>	<p>Value= 5 to 46</p>	<p>Default Value= 25 Step=1</p>
<p>Pedal assistant Mode setting</p>		<p>PAS= Pedal assistant Mode</p>	<p>Value = Dig -3; Dig-5 ; ICON</p>	<p>Dig-3: Digital 3 gear levels Dig-5: Digital 5 gear levels ICON: Eng versi</p>
<p>Speed sensor setting</p>		<p>Ssensor=Speed sensor</p>	<p>Value= 1--12</p>	<p>Default: 1 Step=1; Motor speed measuring magnet number</p>
<p>PAS sensor setting</p>		<p>P-Sensor= PAS sensor</p>	<p>Value= 1-64</p>	<p>Default: 12 Step=1; PAS sensor</p>
<p>PAS sensor direction setting</p>		<p>Dire= PAS sensor direction</p>	<p>Value= F or R</p>	<p>F=Forward R=Reverse Signal direction of sensor, can be adjusted corresponding to right or left</p>

slow acceler ati on setting		Slow-ACC= slow acceleration	Value= 0-3	Default: 0
assistan ce started pulse setting		P- Pulse=assistan ce started pulse	Value= 2-63	Default: 2 Step=1
current limitati on setting		CurLtd= current limitation	Value= 0- 31.5A	Default: 12 Step=0.5A
selec t syste m volta ge setti		SysVol= select system voltage	Value= 24V/36V/4 8V	Default: 36V
low volta ge level setti ng		LowVol= low voltage level	Value= 10.0- 52.0V	Default: 31.5V Step=0.5V

* Note: The wheel diameter value option CCF is the wheel diameter perimeter setting, which requires the support of the controller communication protocol. Parameter 29 means The wheel diameter 29 inches, which needs the support of the corresponding controller communication protocol.

c. Data clearance

Data clearance is aimed at the removal of data information such as subtotal mileage TRIP, average speed, and maximum speed. 10s after display is turned on when display is at function interface, long press M button to show data clearance window, and short press \wedge 、 \vee button to select accordingly. To remove the pop-up clearance window, long press M button or remain no operation for 30s.

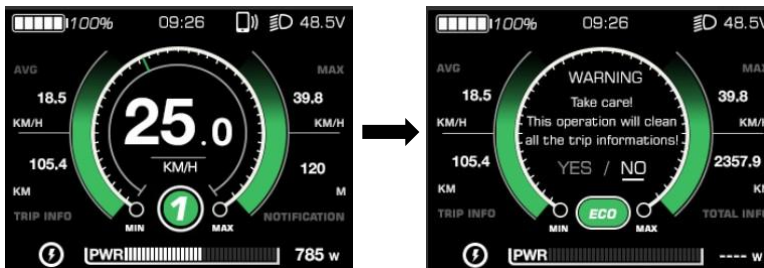

After clearance, the subtotal mileage TRIP is 0, average speed, and max speed is 0. ODO information can't be cleaned manually on the display, professional service tools are required.

•

DISPLAY BUTTON



Short Press: Press the button and soon released, while the button is released, the function activated accordingly

Long Press: Press the button and hold, when the hold time exceeds the setting time (generally 2 seconds), the function activated accordingly.

No.	Function	Operation Method
1	Power on / off	Long Press 'On/Off'
2	PAS Level 12km/h, 15km/h, 20km/h, 25km/h, 32km/h	Short Press ∇ 、 \blacktriangle buttons to switch assist level
3	Switch Speed/Power	Short Press 'M' buttons
5	Walk (Pedestrian mode)	Long Press ∇ buttons
6	Turn on/off headlight	Long Press \blacktriangle buttons

ERROR CODES

Display can warn bike faults. When faults are detected, error code will be shown on the interface and blink at 1Hz. When error code is shown, button functions will not be affected, meaning interfaces can be shown normally by pressing buttons. If no button operation after 5s, the display will return to the error code interface.

Error code interface as shown below:



Error code	Error description	Suggest operation
"21" shown at speed	Current anomaly	Check controller
"22" shown at speed	Throttle anomaly	Check throttle
"24" shown at speed	Motor HALL anomaly	Check motor
"25" shown at speed	Brake anomaly	Check throttle
"26" shown at speed	Under Voltage	Check battery
"30" shown at speed	Communication Fault	Check connector to controller
"31" shown at speed	BMS Fault	Check battery
"32" shown at speed	BMS and controller anomaly	Check controller and battery

CHARGING



CAUTION

Only use the provided charging cable to charge your ASPECT battery pack. Using any other unauthorized charger may cause damage to your battery pack.

CHARGING THE BATTERY RACK

- Ensure the EBIKE is turned off.
- Remove the battery pack from the battery dock.
- Ensure that the charging port is clean and dry.
- Make sure that there is no dust, debris or dirt inside the port.
- Plug the charger into a grounded wall outlet.
- The charging indicator light ON ,the charger will be red.
- Connect the cable with the power supply (100~240VAC).
- Align and connect the 1-pin charging cable into the charging port of the battery pack.

DO NOT FORCE OR BEND THE CHARGING CABLE INTO THE CHARGING PORT, AS IT MAY CAUSE THE PRONG TO BEND OR BREAK.

OPERATING CONDITIONS

FAILURE TO FOLLOW ANY OF THE FOLLOWING SAFETY PRECAUTIONS CAN AND MAY LEAD TO DAMAGE TO YOUR DEVICE, VOID YOUR MANUEACIURER WARRANTY ; LEAD TO PROPERIY DAMAGE, CAUSE SERIOUS BODIIV INJURY, AND CAN LEAD TO DEATH.



Any ASPECT that does not work properly can cause you to lose control and fall. Inspect the entire device thoroughly before every ride, and do not ride it until any problems have been corrected.

KICKSTAND

Never ride your EBIKE with the kickstand down.

OPERATING YOUR Ebike

Make sure the battery pack is fully charged before the first Initial use. Before turning on your E-bike, sit on it like a standard bicycle to get comfortable with the device before using It with the motor.

GEARS

Your ebike is equipped with 7 gears. The lowest gear (1) is for easier and uphill pedaling, and the highest gear (7) is for maximum speed on level or downhill terrain. Change gears only while pedaling.

The rear wheel contains 7 chain sprockets. When the chain is around the largest sprocket you are in 1st gear, or the lowest gear. When the chain is around the smallest sprocket, you are in 7th gear, or the highest gear.

TROUBLESHOOTING

PROBLEM	POSSIBLE CAUSES	SOLUTION
Motor will not engage	<ol style="list-style-type: none"> 1. Low battery 2. Battery loose or unplugged 3. Severed wire connection 	<ol style="list-style-type: none"> 1. Recharge battery 2. Make sure battery connections are secure 3. Contact customer support
Feels shaky when driving	<ol style="list-style-type: none"> 1. Low tire pressure 2. Wheel is not securely fastened 3. Bearings in steering system are worn out 	<ol style="list-style-type: none"> 1. Inflate to 20 psi 2. Fasten wheel securely 3. Replace bearings
Mileage not being recorded correctly	<ol style="list-style-type: none"> 1. Infrequently charged 2. Defective or worn-out battery pack 3. Cold temperature affecting battery performance 4. Defective or incorrect charger damaged battery 	<ol style="list-style-type: none"> 1. Charge battery pack more often 2. Replace battery pack 3. Allow battery pack to reach room temperature and fully recharge it. 4. Contact customer support
LCD Display not registering	<ol style="list-style-type: none"> 1. Low battery 2. Display is broken 3. Bad battery cells 4. Faulty charger burns out display 	<ol style="list-style-type: none"> 1. Recharge battery pack 2. Replace display 3. Replace battery pack 4. Contact customer support

PROBLEM	POSSIBLE CAUSES	SOLUTION
Brakes squealing	<ol style="list-style-type: none"> 1. Dirty brake pad 2. Hard edges on new brakes 3. Brake pads are too tight 	<ol style="list-style-type: none"> 1. Clean the brake pad 2. Squealing will stop the more you ride 3. Adjust brake pads to 1-2mm gap from wheel
Stiffness when steering	<ol style="list-style-type: none"> 1. Grime build-up in steering system 2. Bearings in steering system are worn out 	<ol style="list-style-type: none"> 1. Clean steering system 2. Replace bearings

The above table is only meant to act as a guide to help you figure out any problems you may have with your EBIKE. If you are unable to get your EBIKE to operate properly, please ask for support.

info@taubik.com