

## Fabrication of open stair returns from **Luxury Vinyl Treads** stair noses

This manual shows the two optimal ways of forming a finished edge on open stair returns. The first that will be discussed is the **Traditional cut**, (pg. 2) which mimics the look and design of how solid wood open stair treads have traditionally been constructed. And the second being the **45 cut** (pg. 5) that is generally easier and takes advantage of the components of the luxury vinyl stair tread step construction.

### Traditional Cut



### 45 Cut

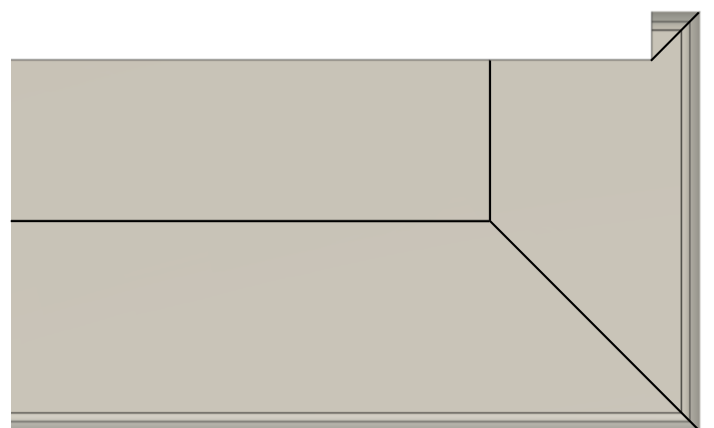

## Traditional Cut

The traditional cut is similar in appearance to how open returns have looked on solid wood stairs traditionally, but can be harder to execute properly. This is made by cutting away a portion of the **Luxury Vinyl Tread (LVT)** stair covering on the open side but leaving a small 45-degree flange at the nose of the stair. This is then mated with a portion cut from another stair nose with two 45-degree angles cut into both ends. One of the 45-degree angles fits into the 45-degree flange of the main stair nose while the other is mated with a finishing 'Chip' that has a mirrored 45-degree cut.

### Caution:

This instruction illustrates the fabrication of a right-hand open stair return. When fabricating a left-hand stair return, be sure to mirror these instructions.

### Step 1.

Connect your stair nose and adjoining luxury vinyl plank (LVP) to make the full tread. The adjoining LVP flooring piece should already be cut down to size to fit the depth of your stair tread. Mark a cut line at a 45-degree angle starting from the front open corner of your stair nose toward the center of the tread. The depth of this cut (Marked as **D** in the image below) is determined by the overall thickness of the luxury vinyl stair nose. Since **Luxury Vinyl Treads** come in two sizes choose the value of **D** from the chart below that corresponds with your **LVT** product. The depth of the cut can be more than the value of **D** found in the chart but should not be less.

Stair noses made to fit 1-1/8" stair treads or less	<b>D</b> = 1-3/4" or more
Stair noses made to fit 1-1/2" stair treads or less	<b>D</b> = 2-1/4" or more

Measure from the outer edge of the open end of the stair the amount of **D** and mark a second line parallel with the outer edge that intersects with the first 45-degree line as shown in the image below on the left. Make your cuts on this line to have the results look like the image below on the right.

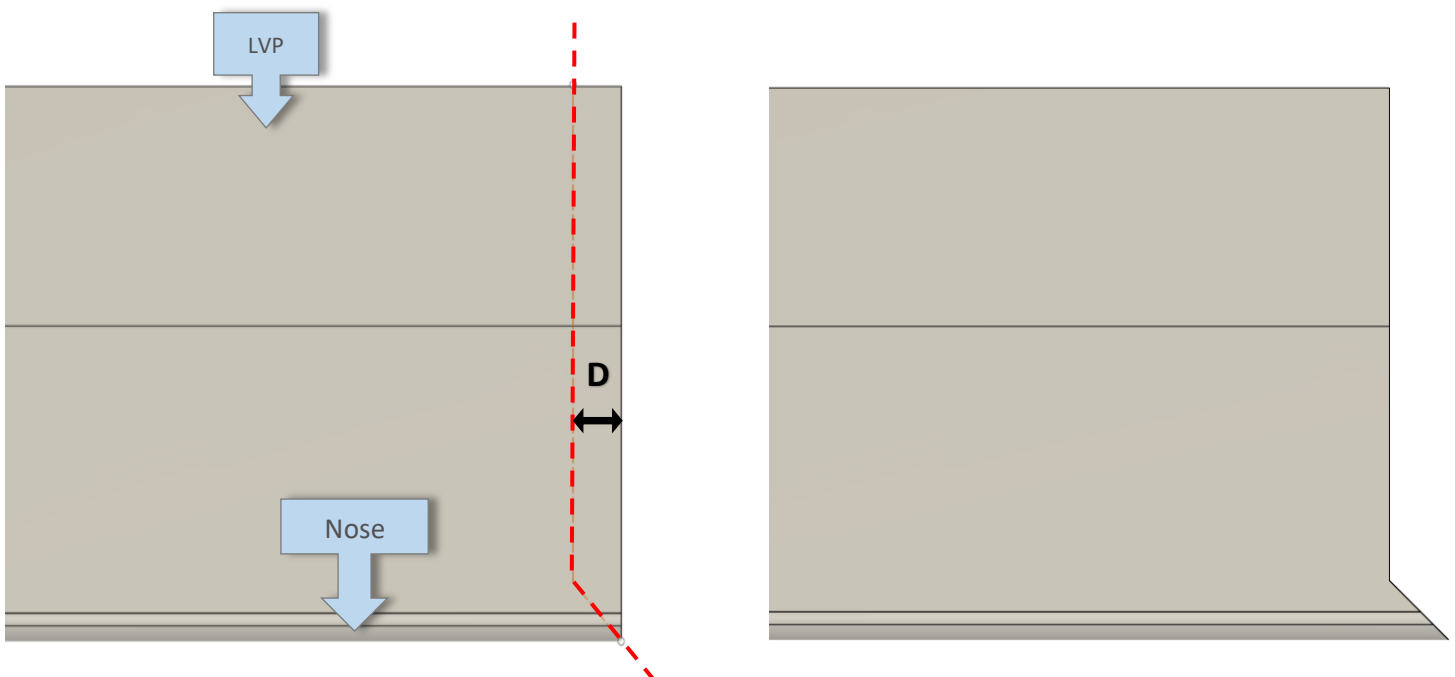

## Step 2.

On the nose of an extra or scrap piece of **LVT** stair nose, measure and mark on the finished edge the length (**L**) the open return is desired to be. This includes any overlap with the adjacent wall beyond the stair tread.

From each end of the **L** measurement make a 45-degree cut line towards the center of measurement **L**. Make another cutline parallel to the nose at the depth of the value of **D** found in **Step 1** that intersects with the two 45-degree angle cut lines as shown in this image. Make your cuts on the marked lines to have the results look like the image below. This component will be referred to as the **Edge Piece**.

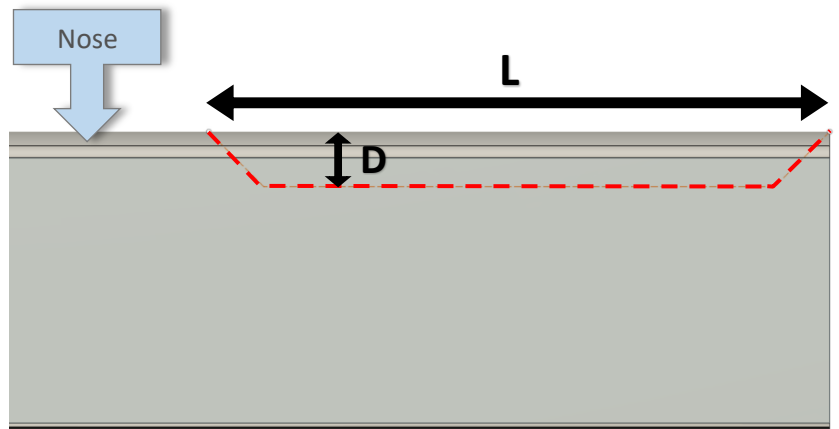

## Step 3.

On the nose of an extra or scrap piece of **LVT** stair nose, Measure the value of **D** found in **Step 1** from the edge of the nose towards the center and make a mark. From this mark make a 45-degree cut line back towards the edge of the stair nose and cut this line. You should now have something that looks like the images below on the left, This component will be referred to as the **Chip**.

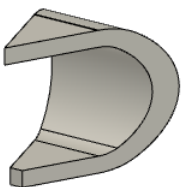
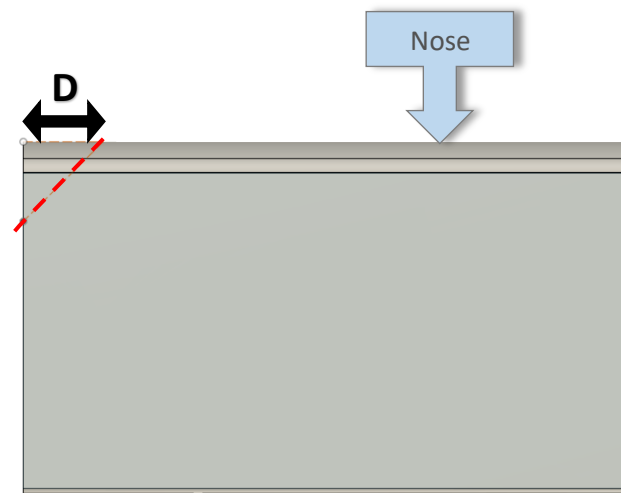

## Step 4.

### Assembly:

Apply glue to the **LVT** stair nose and adjoining luxury vinyl plank (LVP) and place them on the stair tread. For more instructions on best ways to prepare and adhere the **LVT** products to stairs please check out our **Luxury Vinyl Treads Stair Installation Guide** on our installation page at [www.luxuryvinyltreads.com/installation](http://www.luxuryvinyltreads.com/installation)

### Assembly of the open return:

- Assemble the open stair return by applying flooring adhesive to the **Edge piece** and placing it up against the 45-degree flange of the **LVT** stair nose that was made in **Step 1**.
- Then apply flooring adhesive to the **Chip** and place it on the other 45-degree angle of the **Edge piece** making sure to orient the two rounded noses together and the flat side of the **Chip** towards the wall.
- For best results, secure parts in place with painters' tape for 24 hours and apply matching caulk to the seams of the stair tread joints.

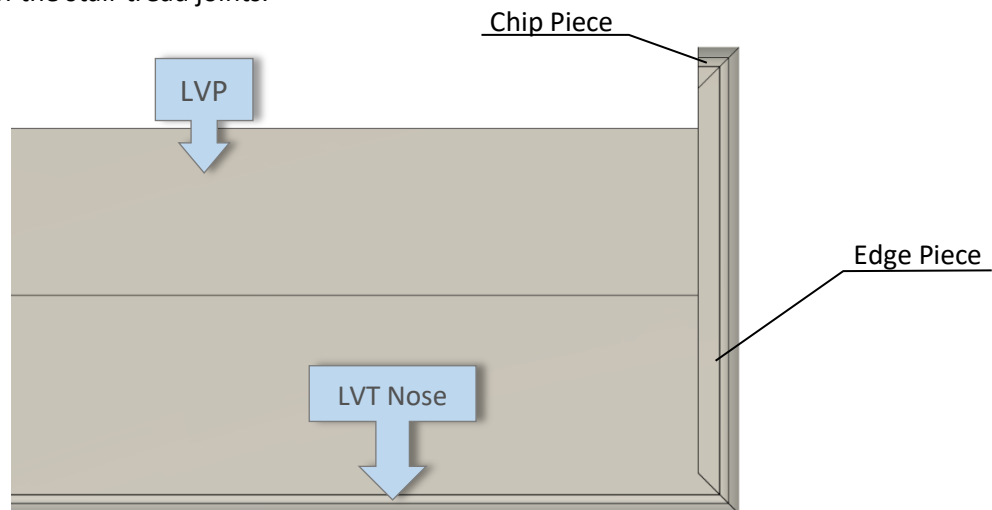

## 45 Cut

The 45 Cut takes advantage of the nature of **Luxury Vinyl Tread (LVT)** step construction. Since the **LVT** stair covering is made of two components, a nose and an adjoining plank, the full nose can simply be cut at a 45-degree on the open return side. An edge piece is then cut and trimmed to mate with the nose's 45 degree cut, and then a section is cut out on the back to fit to the stair riser and wall. The Chip piece is then cut and inserted between the finished edge and the adjacent wall.

### Caution:

This instruction illustrates the fabrication of a right-hand open stair return. When fabricating a left-hand stair return, be sure to mirror these instructions.

### Step 1.

From the corner of the nose of the **LVT** stair nose make a 45-degree cut line toward the back of the plank. Cut the stair nose on the cut lines and you should have the result shown as the image on the right.

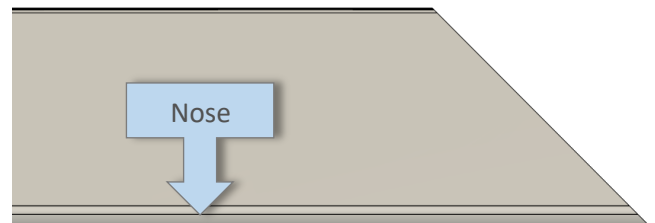
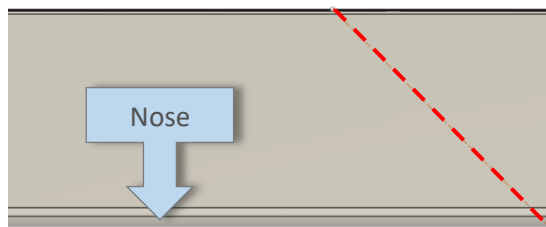

### Step2.

Take the LVT nose and place it on the stair tread, measure from the tip of the stair tread to past the riser where you would like the open return to terminate. Take that measurement (**L**) and transfer it to the nose of an extra or scrap piece of **LVT** nosing. At that measurement, mark a cut line from the nose straight across to the click side of the **LVT** nose. From the edge of the nose, mark a cut line at 45-degrees to the back click. Cut both marks and the results should be similar to the picture on the right.

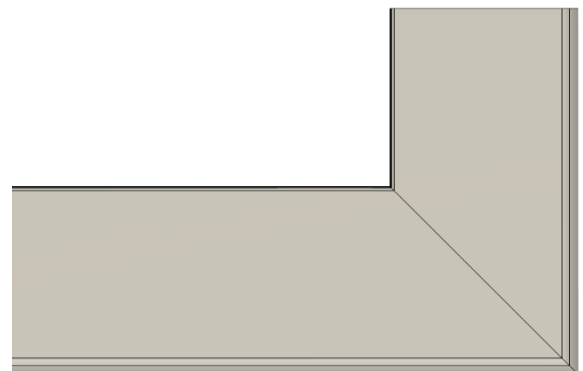
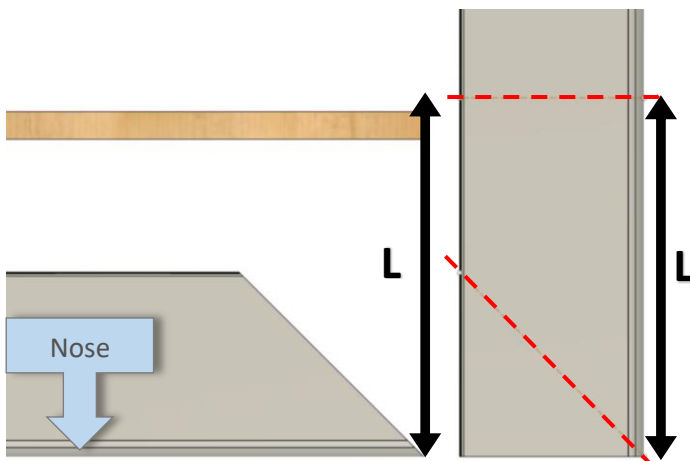

### Step 3.

Transcribe the dimensions and placement of the riser on to the edge piece made in the last step. Cut out the markings and the results should look like the image on the right.

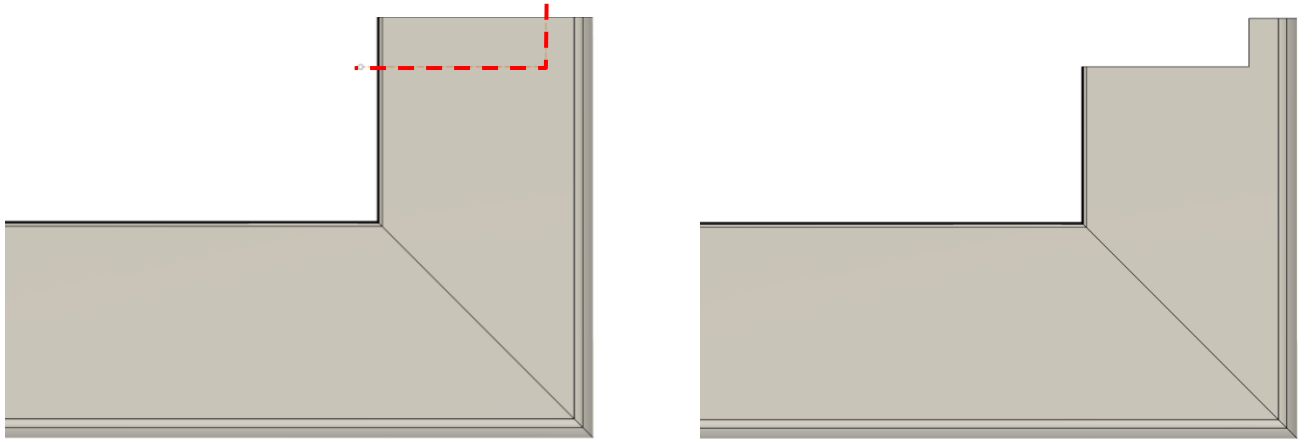

### Step 4.

On the end of the edge piece closest to the stair riser, measure the depth of the flange that sticks out over the adjacent wall (**D**). From the same corner, mark a 45-degree angle cut line and cut along it so that you're left with the results of the image on the right.

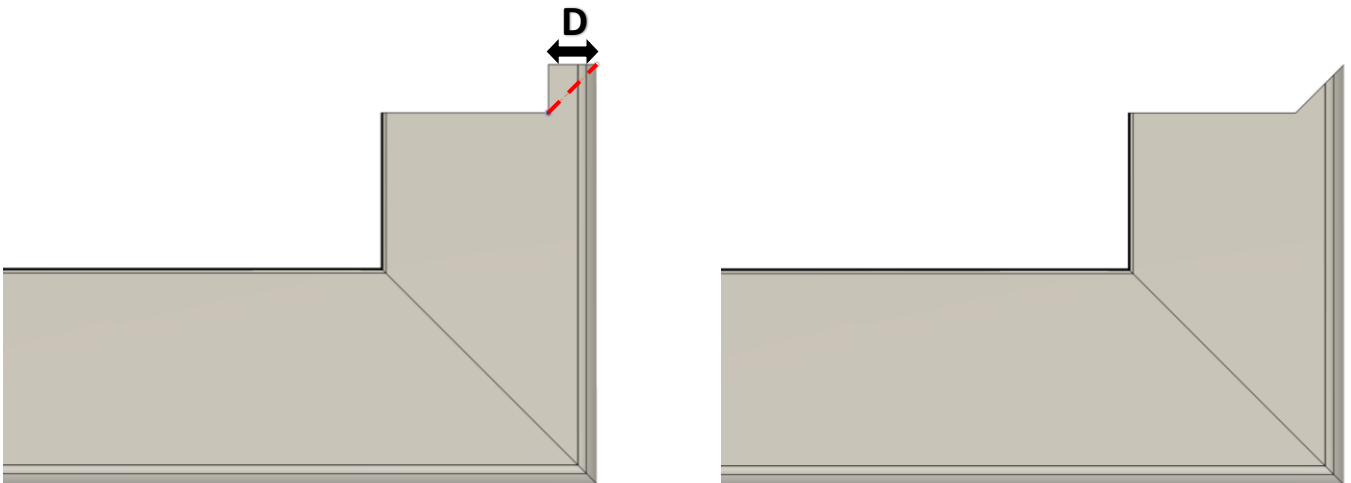

## Step 5.

On the nose of an extra or scrap piece of **LVT** stair nose, Measure the value of **D** found in **Step 4** from the edge of the nose towards the center and make a mark. From this mark make a 45-degree cut line back towards the edge of the stair nose and cut this line. You should now have something that looks like the images below on the left that will be referred to as the **Chip**.

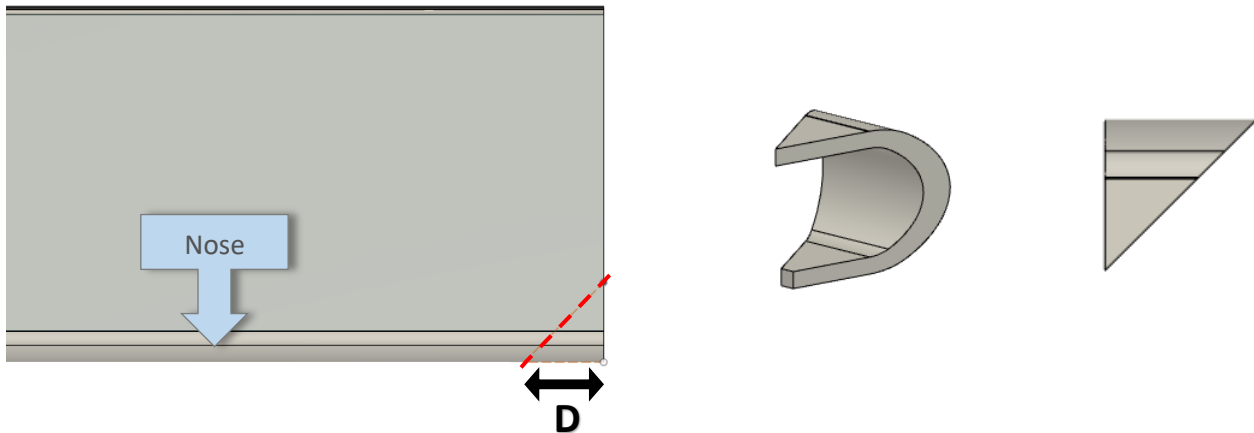

## Step 5.

Get the depth and length measurements needed for the adjoining flooring plank, and transfer them to an extra flooring plank. Keep track of the click type that is needed to join with the nose and edge piece.

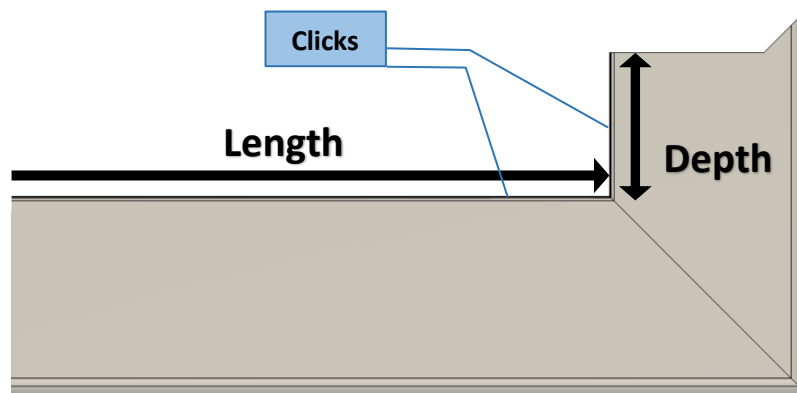

When transferring the measurements to the luxury vinyl plank (LVP) be sure that the two clicks that are not being cut off connect with the nose and edge piece. Now cut the plank according to the dimensions.

**Note:** In some cases, a reverse click stair nose would be needed in order for the edge piece to be able to click into the plank. If that is not available, the click of the edge piece and the luxury vinyl plank (LVP) can be trimmed off so that during assembly they can butt-up against each other.

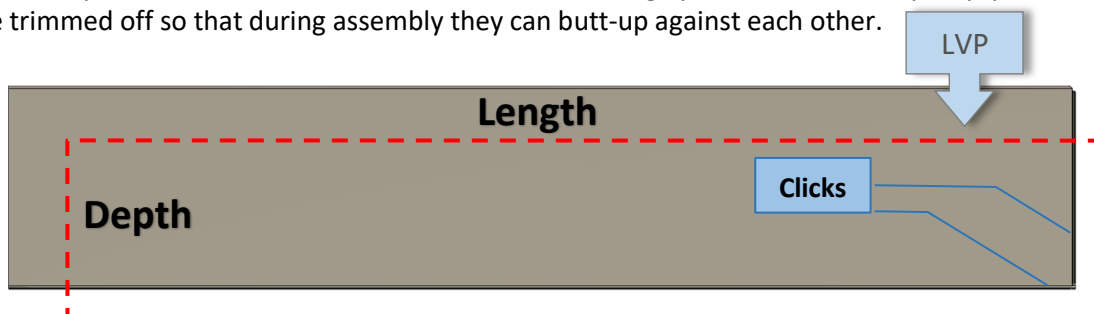

## Step 6.

### Assembly:

Apply glue to the **LVT** stair nose and adjoining luxury vinyl plank (LVP) and place them on the stair tread. For more instructions on best ways to prepare and adhere the **LVT** products to stairs please check out our **Luxury Vinyl Treads Stair Installation Guide** on our instruction page at [www.luxuryvinyltreads.com/installation](http://www.luxuryvinyltreads.com/installation)

### Assembly:

- Assemble the open stair return by applying flooring adhesive to the **Edge piece** and placing it up against the 45-degree angle of the **LVT** stair nose that was made in **Step 1**. Be sure to click it in with the edge click of the adjoining flooring plank made in **Step 5**.
- Then apply flooring adhesive to the **Chip** and place it on the other 45-degree angle of the **Edge piece** making sure to orient the two rounded noses together and the flat side of the **Chip** towards the wall.
- For best results, secure parts in place with painters' tape for 24 hours and apply matching calk to the seams of the stair tread joints.

