

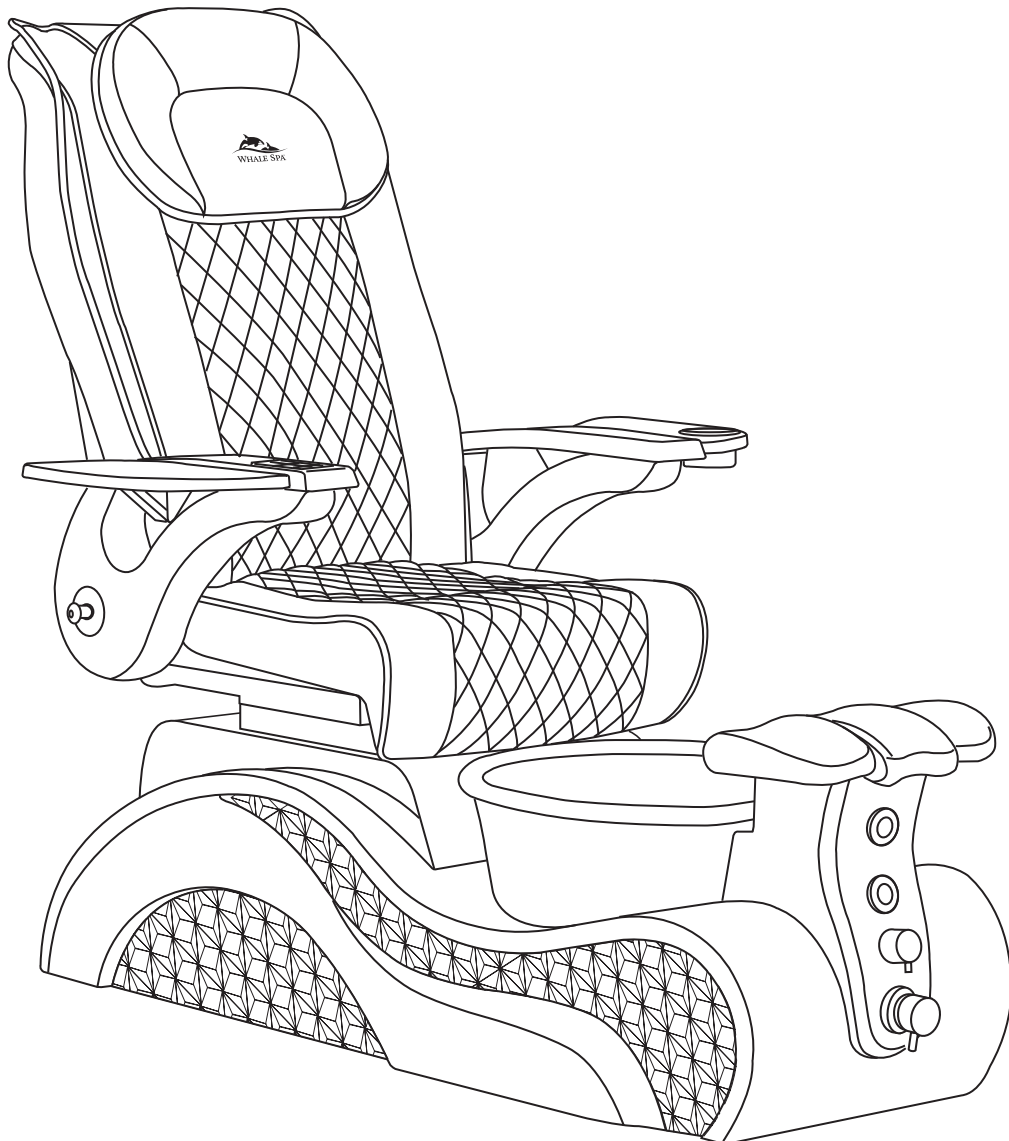

# OWNER MANUAL

PLEASE SAVE THIS MANUAL FOR FUTURE REFERENCE

## LUCENT



# Table of Contents

## Owner Manual

|  |     |
|--|-----|
| Limited Warranty .....                   | 4   |
| Safety and Precautions .....             | 5-6 |
| Installation .....                       | 7   |
| Pedicure Components .....                | 8   |
| Clearances .....                         | 9   |
| Jet Removal & Ifill 3 reset/reboot ..... | 10  |
| Plumbing Connections .....               | 11  |

Whale Spa, Inc. ("Whale Spa") conditionally warrants your pedicure spa (the "Pedicure Spa") in accordance with the terms and conditions set forth below for a period of two (2) years commencing on the original date of shipment of the Pedicure Spa to you. The warranty only applies to the Pedicure Spa's original end-user owner or customer (the "Customer"). This Conditional Warranty is non-transferable and replaces any warranties previously published by Whale Spa.

If examination of the Pedicure Spa by Whale Spa during the applicable warranty period shows it to have a defect in material or workmanship, Whale Spa will, at its option, repair or replace the defective component or part thereof. Further, Whale Spa may, at its discretion, replace a defective component or part with a refurbished component or part, or may replace the Pedicure Spa with a refurbished pedicure spa. If Whale Spa elects to replace the Pedicure Spa, the replacement pedicure spa must be comparable in style and size to the Pedicure Spa. The Customer shall bear all charges incurred for the shipment to it of replacement components or parts, or a replacement pedicure spa, and the cost of all labor incurred in repairing defects in the Pedicure Spa or repairing or replacing any of its defective components or parts. The forgoing limited warranty does not apply:

- to the Pedicure Spa, or any components or parts thereof, if subjected to misuse or neglect or if accidentally or intentionally damaged.
- to the Pedicure Spa, or any components or part, if altered or modified in any way.
- to any expenses incurred by the Customer or any third party, including labor or material, during investigation, removal or reinstallation of the Pedicure Spa or any defective components or parts.
- to any damage to or impairment of the Pedicure Spa, or any components or parts thereof, caused by any casualty, including without limitation, accident, fire, wind, floods, acts of nature or attempted theft.
- to any workmanship of a fabricator (other than Whale Spa) or installer of the Pedicure Spa.
- if damage to pump parts and/or motor parts is due to obstructed plumbing.
- if the Pedicure Spa is removed from its place of initial installation.
- to staining, fading, or discoloration of any portion of the Pedicure Spa caused by water additives or improper water treatment.
- to staining, fading or discoloration of the Pedicure Spa's upholstered seat, armrests or footrests.
- to malfunctions or damage caused by improper installation of the Pedicure Spa, including, but not limited to, failure to meet local, state, or local plumbing, electrical and building codes.
- to damage resulting from a person standing in the Pedicure Spa's basin or other similar stress to that basin.
- to freight damage.
- to damage incurred to the Pedicure Spa while in possession of any party other than Whale Spa.

This forgoing conditional limited warranty is also conditional upon:

- the Pedicure Spa being installed by a licensed professional in accordance with Whale Spa's installation instructions.
- the proper use of cleaning and sanitizing solutions in accordance with the instruction labels provided by Whale Spa. Repeated use of concentrated chlorine or other chemicals will void this limited warranty.
- avoidance of the use of ionic detox machines that submit any metallic part to reverse electroplating; this use will destroy plated parts and void the warranty.
- shipment, if requested, to Whale Spa of Pedicure Spa parts or components thought to be defective. Parts or components may only be returned if authorized in advance by Whale Spa. All returns must be freight prepaid.
- determination by Whale Spa, in its reasonable discretion, that there exists a defect in material or workmanship. Repair or replacement of any part or component under this Limited Warranty, or furnishing a replacement pedicure spa, shall not extend the duration of the warranty with respect to such repaired or replaced part beyond the stated warranty period. When a part or component is replaced, it will be under warranty for 90 days, or for the remaining life of original warranty, whichever period is greater. Customer agrees by using the Pedicure Spa that:

**• THE OBLIGATION OF WHALE SPA SHALL NOT EXTEND TO INDIRECT OR CONSEQUENTIAL DAMAGES OR INJURY WHICH MAY RESULT FROM SUCH USE**

- that the obligations of Whale Spa are limited to those set forth herein • this warranty is limited to the original owner/end-user and is non-transferable • Whale Spa shall not be liable for any other obligations or liabilities, including, but not limited to: obligations or liabilities arising out of breach of contract or warranty, negligence, or other tort or any theory of strict liability with respect to the Pedicure Spa or parts or components thereof or any acts or omissions of Whale Spa.
- Any assistance Whale Spa provides to the Customer outside of terms, limitations, or exclusions of this limited warranty will not constitute a waiver of any of the foregoing terms, limitations, or exclusions, nor will such assistance extend or revive the warranty.

THIS LIMITED WARRANTY IS IN LIEU OF ALL OTHER WARRANTIES, EITHER EXPRESS OR IMPLIED, AND ALL SUCH OTHER WARRANTIES, INCLUDING WITHOUT LIMITATION, IMPLIED WARRANTIES OF MERCHANTABILITY OR FITNESS FOR A PARTICULAR PURPOSE, ARE HEREBY DISCLAIMED AND EXCLUDED FROM THIS LIMITED WARRANTY. NO DEALER OR OTHER PERSON HAS ANY AUTHORITY TO BIND WHALE SPA TO CHANGES OR ADDITIONS TO THIS WARRANTY OR ITS PRODUCTS. ACCORDINGLY, WHALE SPA IS NOT RESPONSIBLE FOR ANY SUCH OUTSIDE WARRANTIES OR REPRESENTATIONS. IN NO EVENT SHALL WHALE SPA BE LIABLE IN ANY WAY FOR ANY CONSEQUENTIAL, SPECIAL, OR INCIDENTAL DAMAGES OF ANY NATURE WHATSOEVER, OR FOR ANY AMOUNTS IN EXCESS OF THE SELLING PRICE OF THE PEDICURE SPA OR ANY COMPONENTS OR PARTS THEREOF FOUND TO BE DEFECTIVE. THIS LIMITED WARRANTY GIVES THE CUSTOMER SPECIFIC LEGAL RIGHTS. THE CUSTOMER MAY ALSO HAVE OTHER RIGHTS WHICH MAY VARY BY EACH JURISDICTION.

For troubleshooting visit: [whalespains.com/troubleshoot](http://whalespains.com/troubleshoot)  
Should your Pedicure Spa require service, please contact:

**Whale Spa – Technical Support**

1-888-650-7888

email: [info@whalespa.com](mailto:info@whalespa.com)

## SAFETY & PRECAUTION

The Whale Spa pedicure chairs (herein referred to as pedicure spa) are innovative pedicure spas that have been designed to serve you dependably for many years. Please take time to thoroughly read this entire manual before installation and use. If you have any problems or have questions regarding your pedicure spa, please contact Whale Spa's Technical Support Department at info@whalespa.net or call 1-888-650-7888, Monday through Friday 10 AM to 6 PM PST.

Whale Spa requires that you contact a local, licensed plumber and licensed electrician to install your new pedicure spa.

Installation must be in compliance with all your local and state building codes. Your pedicure spa cannot operate efficiently or safely unless it is provided with adequate electrical power, sufficient water pressure, proper water temperature, and required drainage capabilities. Contact your local building inspector for information and local code compliance procedures that need to be followed when having your pedicure spa installed. Subsequent inspections and approvals that may be required are the responsibility of the purchaser. (See limited warranty regarding incidental or consequential exclusions)

- 1) **WARNING: RISK OF ELECTRIC SHOCK:** do not permit electric appliances (such as a hair dryer, lamp, telephone, radio, or television) within 1.5M of this pedicure spa.
- 2) **CAUTION:** Test the ground fault circuit interrupter protecting this appliance periodically in accordance with the manufacturer's instructions.
- 3) Temperatures sufficiently high to cause burns may occur regardless of the control setting.
  - a. Do not use on...
    - Infants
    - Sleeping or unconscious persons.
  - b. Do not use on...
    - Sensitive skin
    - Person with poor blood circulation.

**Note: Check the skin in contact with the heated area of the appliance frequently to reduce the risk of blistering.**

- 4) Excessive water temperature is dangerous and should be checked before use. Maximum operating water temperature should not exceed 105 F (41 C) and the maximum supply water temperature should not exceed 150 F (65 C).
- 5) The spa could have a heated surface in the seat back cushion. Persons sensitive to heat must be careful when using the spa.
- 6) Always enter and exit the pedicure spa slowly and carefully.
- 7) Close side arm rests before operating the chair seat movement.
- 8) Never bring or operate any electrical devices into or near the pedicure spa.
- 9) This pedicure spa has a weight capacity of 250 pounds.
- 10) Use only while seated.
- 11) Connect this appliance to a properly grounded outlet only. See Grounding Instructions within the install manual.

**Note: Always verify maximum temperatures with your local & state codes.**



### Warning

Individuals whose feet or legs are inflamed or have open wounds should not be allowed to use the pedicure spa at any time. Nail technicians should advise clients to consult their physician before using the pedicure spa if there is any sign of fungal infection, swelling, fracture, or persistent pain. In some cases diabetics may experience improved circulation in their feet, but should first consult their physician prior to receiving a pedicure. If the client experiences any pain or discomfort, immediately discontinue the use of the pedicure spa. Your client's massage and pedicure spa experience should be pleasant and comfortable.

## SAFETY & PRECAUTION

### Important Installation and Utility Information

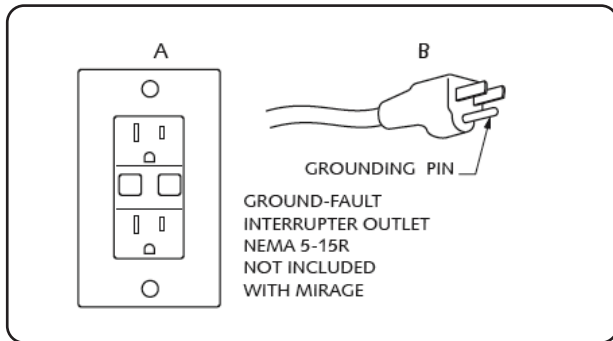

**COMPLIANCE WITH LOCAL CODES OR INSPECTIONS IS THE RESPONSIBILITY OF THE PURCHASER AND/OR INSTALLER**

#### **Electrical Service:**

110V: A 110V, 60 Hz, 15 Amp GFCI protected grounded circuit must be used to supply power to the pedicure spa. (220V if ordered in 220V configuration)

#### **Water Supply:**

All plumbing connections must conform to local codes. Normal water pressure of 30 to 80 PSI is required to correctly fill the basin to the proper level. The hot water supply temperature must not exceed 150 F (65 C). Adjust your hot water heater accordingly. Carefully connect the incoming water supply lines to the appropriate fittings located on the back of the pedicure spa. Shut-off valves are recommended.

#### **Basin capacity:**

4.5 US gallons of water per pedicure service.

#### **Backflow Protection Devices for Faucets with Side Spray:**

Check valves comply with ANSI/ASME A112.18.3M, A112.18.1M, and CSA B125 ANSI/ASME A112.18.3M (Performance Requirements for Backflow Protection Devices and Systems in Plumbing Fixture Fittings) is applicable to plumbing fixture fittings with outlets not protected by an air gap.

Included in the possible range of applications are fittings with hose connected outlets, fittings with pullout spout, hand held showers, shampoo fittings and deck-mounted fittings. ASME A112.18.3M is now referenced in ASME A112.18.1M (Plumbing Fixture Fittings) and CSA B125.

Check valves are listed to both standards with the Canadian Standards Association, IAPMO and UL. ANSI - American National Standards Institute

ASME - American Society of Mechanical Engineers CSA - Canadian Standards Association IAPMO - International Association of Plumbing and Mechanical Officials UL - Underwriters Laboratory

The pedicure spa drain must meet local plumbing codes. Check valve for drain (not provided) must be installed by a licensed plumber.

## INSTALLATION

### Install Seat to The Base

1. Remove **pedicure spa base** from its box and place at the location where it will be installed.
2. Remove the **massage backrest** from its box and place aside. Remove the **seat base/armrest frame** from the same box and place on top of **pedicure spa base**.
3. Align four screw holes and insert screws to affix **seat base/armrest frame** to **pedicure spa base**.
4. Lay **massage backrest** flat onto **seat base/armrest frame**. Lift **massage backrest** upward and align the pivots onto their housing. Pivots are located at the lower left and right sides of chair.
5. Gently recline **massage backrest** until it clicks into place. Attach leather seat cushion, leather seat back, and leather pillow. (Note: **Green connector wire** under seat cushion is for seat vibration function. Seat vibration function is no longer offered.)
6. Connect **Power Seat Controller** connector (located behind right rear arm rest) to respective connector at rear of **pedicure spa base**. (Note: Power Seat Controller is optional, thus may not be equipped on your unit.)
7. Secure foot rest to **pedicure spa base**.
8. See page 11 for plumbing connections.

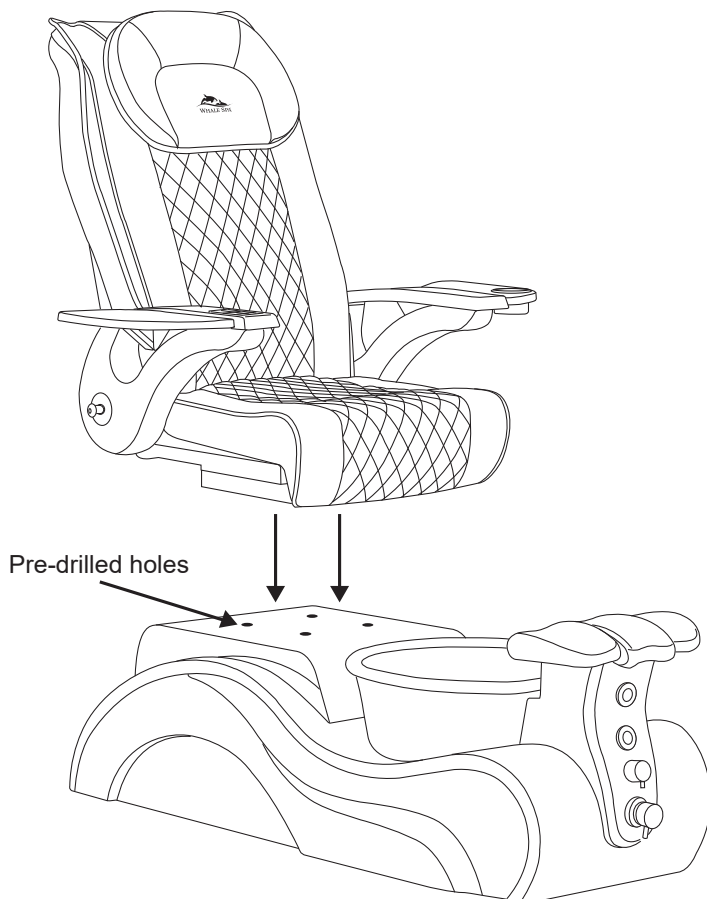

### Back Panel Plumbing Connection

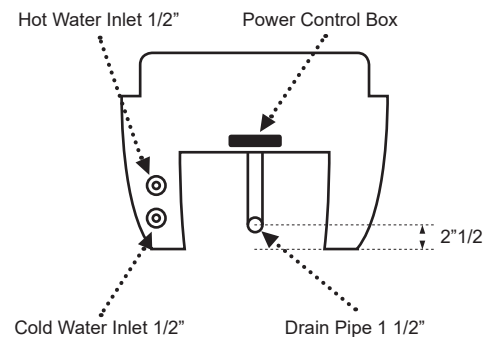

## PEDICURE COMPONENTS

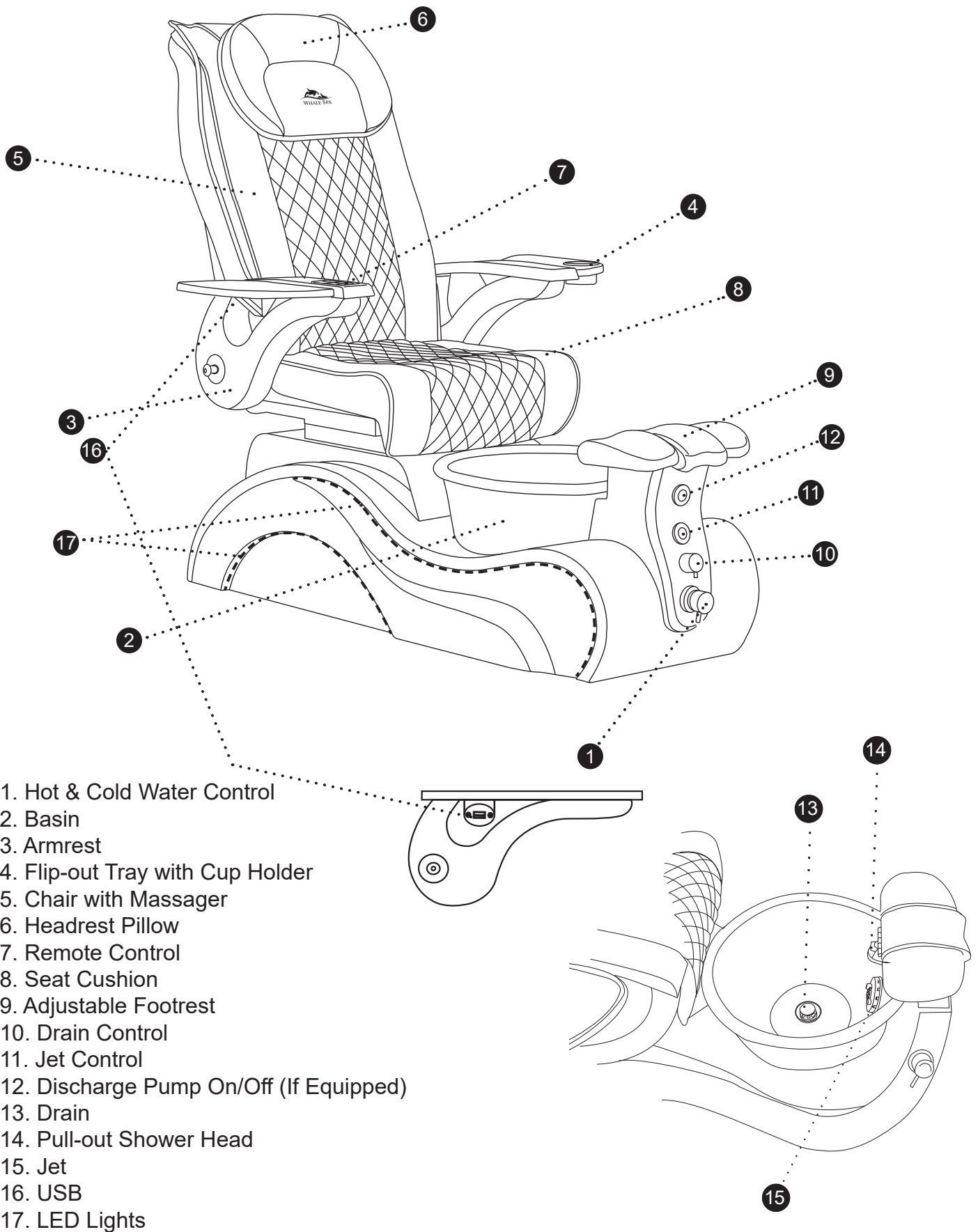

1. Hot & Cold Water Control
2. Basin
3. Armrest
4. Flip-out Tray with Cup Holder
5. Chair with Massager
6. Headrest Pillow
7. Remote Control
8. Seat Cushion
9. Adjustable Footrest
10. Drain Control
11. Jet Control
12. Discharge Pump On/Off (If Equipped)
13. Drain
14. Pull-out Shower Head
15. Jet
16. USB
17. LED Lights

# CLEARANCE

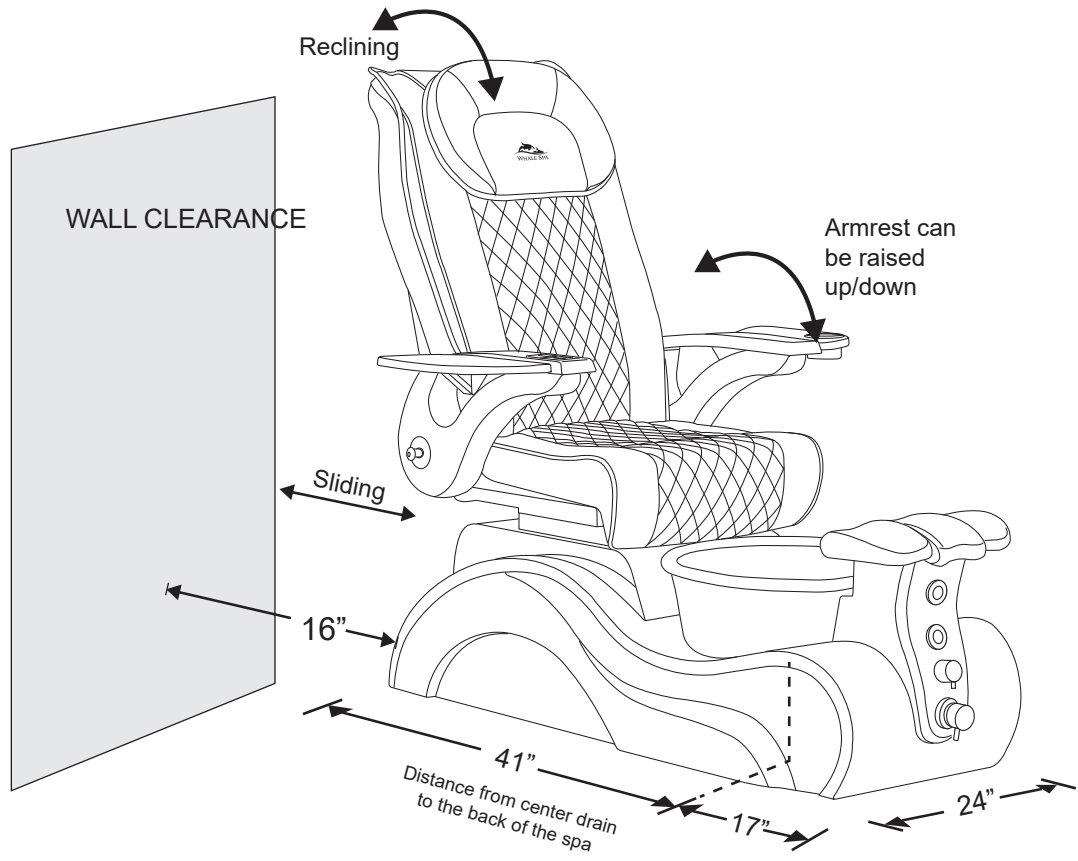

## TYPICAL FOOT-SPAS

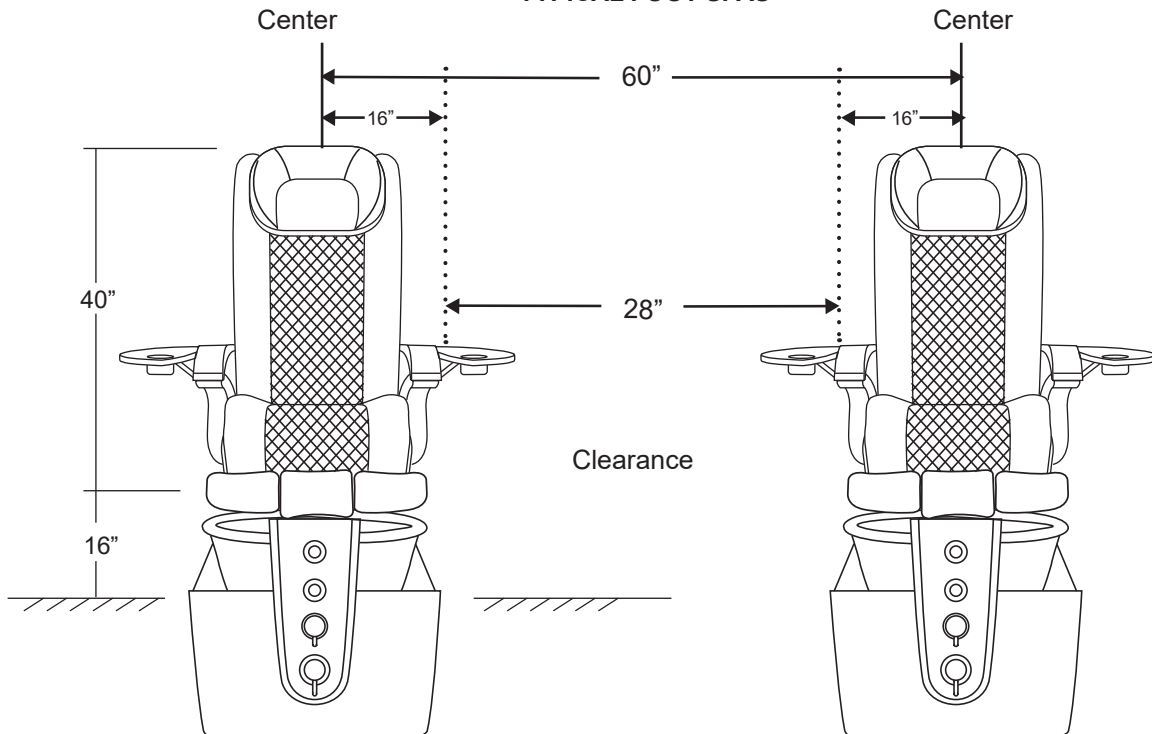



## IMPORTANT MAINTENANCE AND CARE

### Magnet Jet Care

**NEVER** run jet without magnet jet head being fully submerged in water. Doing so, even for a short time, will result in damage to the head.

**Note:** Magnet Jet head is a wear and tear item and is not covered under warranty.

**Always ensure jet motor is off when not in use.**

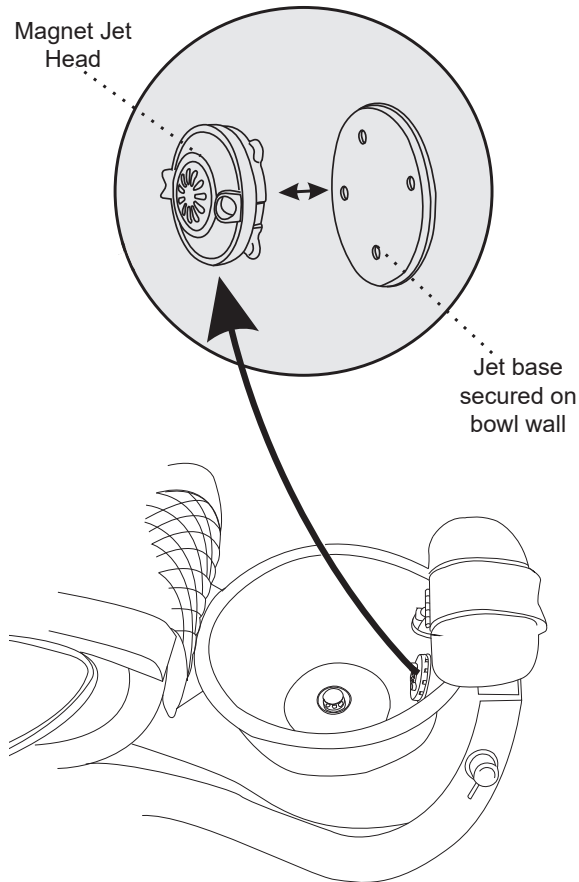

### Magnet Jet Use

To remove the magnet jet head:  
Gently pull the magnet jet head away from jet base.  
Twist off cap.

To install the magnet jet head:  
Assemble all magnet jet head components in order as before removal, snap the magnet jet head onto jet base located on tub/bowl wall securely.

### Leather and Foam Pad

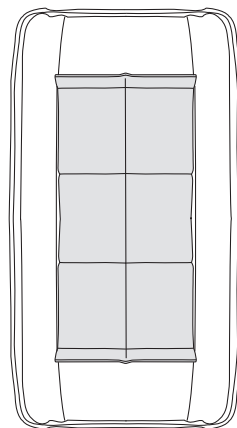

**Check the foam pad once a year and replace if flattened**

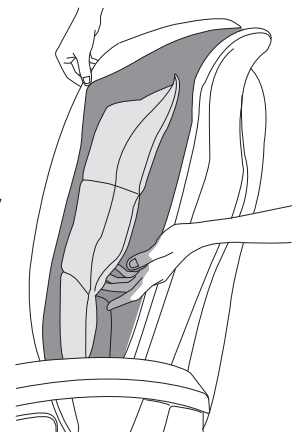

The foam pad attaches to the backside of the backrest leather and protects the leather from excessive wear.

**Leather Care:** Clean with mild soap and water. For stubborn stains, spot clean with 99% alcohol.

### Check Valve

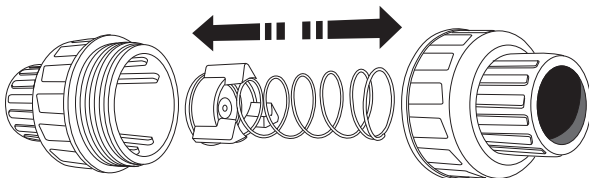

For discharge pump equipped spa chairs, check valve may require periodic cleaning:

1. Slowly twist open check valve, note position of the spring/plunger.
2. Clean out check valve, place spring/plunger in original location, twist close.

### How To Use OneTouch™ Auto Fill

Step 1: Press Power (⏻) button

Step 2: Open faucet valve (ensure that water temperature is not overly hot).

Step 3: Press Auto Fill (🌊) button. Water will fill the basin and will automatically shut off when the water level is adequate. The magnet jet will start automatically. Only press Auto Fill button when basin is empty to prevent overflow.

To stop water anytime, press the Auto Fill (🌊) button again.

**PLEASE NOTE:**

- To additionally fill, press the Fill button (🚰) to turn On/Off the water manually.
- Pressing the Jet (🌀) button will turn On/Off the Jet manually.

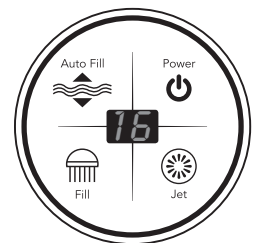

1. Place the pedicure chair at least 16" from the wall and on a level and stable surface.
2. Hot and cold water supply line fittings are 1/2" and are located at the rear of the unit.
3. Drain can be extended with a 1 1/2" PVC pipe. Use of a floor sink is recommended.
4. The electrical outlet used to supply power to each pedicure chair must be 110V, 60Hz, 15 Amp GFCI protected and grounded.

The installation must comply with federal, state, and local building, electrical, and safety codes, where applicable. Installation must be completed by a licensed plumber. Failure to comply with the above may void the warranty.

## DIMENSIONS

Lucent 58" L x 31" W x 52" H (Trays Down)

Lucent 58" L x 43" W x 52" H (Trays Up)

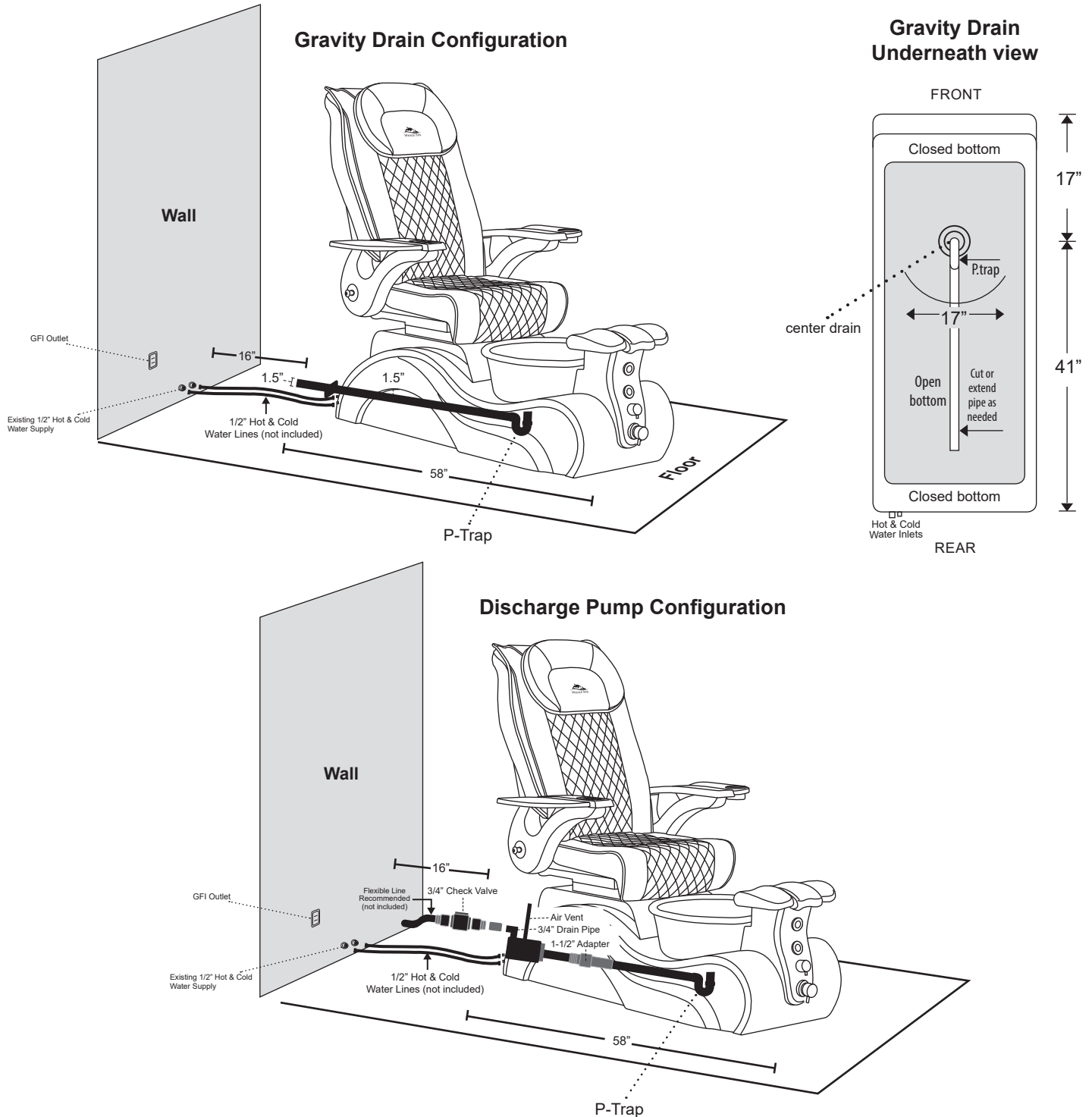

# IAPMO RESEARCH AND TESTING, INC.

5001 E. Philadelphia Street, Ontario, CA 91761 • Phone (909) 472-4100 • Fax (909) 472-4244 • www.iapmort.org



## CERTIFICATE OF LISTING



IAPMO Research and Testing, Inc. is a product certification body which tests and inspects samples taken from the supplier's stock or from the market or a combination of both to verify compliance to the requirements of applicable codes and standards. This activity is coupled with periodic surveillance of the supplier's factory and warehouses as well as the assessment of the supplier's Quality Assurance System. This listing is subject to the conditions set forth in the characteristics below and is not to be construed as any recommendation, assurance or guarantee by IAPMO Research and Testing, Inc. of the product acceptance by Authorities Having Jurisdiction.

This certificate is not evidence of current listing. To verify listing status, visit the IAPMO R&T Product Listing Directory at [pld.iapmo.org](http://pld.iapmo.org)

*Issued To:*

### WHALE SPA INC.

8881 WARNER AVE. HUNTINGTON BEACH, CA 92647 , United States

*Product:*

### Pedicure Fixture

*Products are in compliance with the following code(s):*

**Uniform Plumbing Code (UPC®)**  
**National Plumbing Code of Canada**

*Products are in compliance with the following standard(s)*

**IAPMO IGC 281-2015a and CSA B45 Series-2002 (R2013)**  
**including Updates through No. 5 dated June 2009**

File Number: 12571

Effective Date: August 2020

Void After: August 2025

  
Chairman, Product Certification Committee



  
CEO, The IAPMO Group

This listing period is based upon the last date of the month indicated on the Effective Date and Void After Date shown above. Any change in material, manufacturing process, marking or design without having first obtained the approval of the Product Certification Committee, or any evidence of non-compliance with applicable codes and standards or of inferior workmanship, may be deemed sufficient cause for revocation of this listing. Production of or reference to this form for advertising purposes may be made only by specific written permission of IAPMO Research and Testing, Inc. Any alteration of this certificate could be grounds for revocation of the listing. This document shall be reproduced in its entirety.

# IAPMO RESEARCH AND TESTING, INC.

## CERTIFICATE OF LISTING

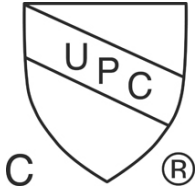

Issued To: WHALE SPA INC.

Effective Date: August 2020

File Number: 12571

Product: Pedicure Fixture

Void After: August 2025

This certificate is not evidence of current listing. To verify listing status, visit the IAPMO R&T Product Listing Directory at [pld.iapmo.org](http://pld.iapmo.org)

### Identification:

Product shall be permanently and legibly marked with manufacturer's name or trademark, and model number. Product shall also bear the cUPC® certification mark. Markings shall be applied so as to be visible after installation.

### Characteristics:

Pedicure Fixture consists of a foot tub fixture that may be equipped with components such as supply fittings, waste fittings, with or without a chair, and/or jet(s) and suction fitting(s) to circulate water. To be installed in accordance with the manufacturer's instructions and the latest edition of the Uniform Plumbing Code.

Products listed on this certificate have been tested by an IAPMO R&T recognized laboratory. This recognition has been granted based upon the laboratory's compliance to the applicable requirements of ISO/IEC 17025.

## UL PRODUCT CATEGORY

### Plumbing Accessories

See General Information for Plumbing Accessories

#### **WHALE SPA, INC.**

14282 BROOKHURST ST, SUITE 1  
GARDEN GROVE, CA 92843 USA

E329848

**Pedicure spas, "Apex Junior Series"**, Model(s) SPA I, SPA II

**Pedicure spas, "Apex Series"**, Model(s) 55i, 60i

**Pedicure spas, "Whale Series"**, Model(s) Allure, Deluxe #1, Era #5, Harmony #7, Serenity, Tawa, WS 400, WS 500, WS 600, WS 65i Lyptus, WS 700, WS 75i Alden, WS 800, WS 85i, WS 900

Last Updated on 2019-08-22

The appearance of a company's name or product in this database does not in itself assure that products so identified have been manufactured under UL's Follow-Up Service. Only those products bearing the UL Mark should be considered to be Certified and covered under UL's Follow-Up Service. Always look for the Mark on the product.

UL permits the reproduction of the material contained in the Online Certification Directory subject to the following conditions: 1. The Guide Information, Assemblies, Constructions, Designs, Systems, and/or Certifications (files) must be presented in their entirety and in a non-misleading manner, without any manipulation of the data (or drawings). 2. The statement "Reprinted from the Online Certifications Directory with permission from UL" must appear adjacent to the extracted material. In addition, the reprinted material must include a copyright notice in the following format: "© 2019 UL LLC".



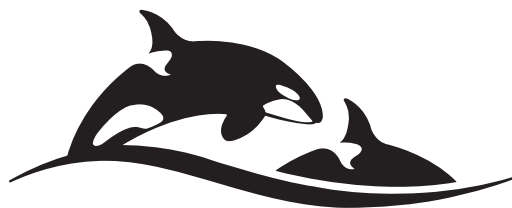

WHALE SPA®

[www.WhaleSpa.com](http://www.WhaleSpa.com)