

Puelche[™] Boot Dryers provide an elegant, space saving, customizable choice for wall mounted boot and glove dryers.



Boot dryer is installed inside a wall.

When not in use, the dryer is a very thin panel on the wall taking up zero floor space.

When needed, pegs are extended for use.

High volume warm air only goes to pegs that are extended.

Connects direct to building wiring.

Constructed of durable stainless steel.

Timer controlled. Heat on / off switch.

Customizable configuration and finishes.

We strive to make the best, most attractive boot dryers possible.

***Puelche is the South American equivalent of a Santa Ana Wind.**

Features



- Stainless steel are pegs 1" square.
- Pegs are housed flush with the surface.
- A light push on the peg and it clicks open for use.
- When open, air can flow thru the peg.
- A plastic tip eliminates sharp metal edges.
- Deflectors in the tip direct air to the toe of the boot.
- A light push on the peg and it will click back inside the face.

Video link

www.youtube.com/watch?v=KPJTWy_uYys

Features

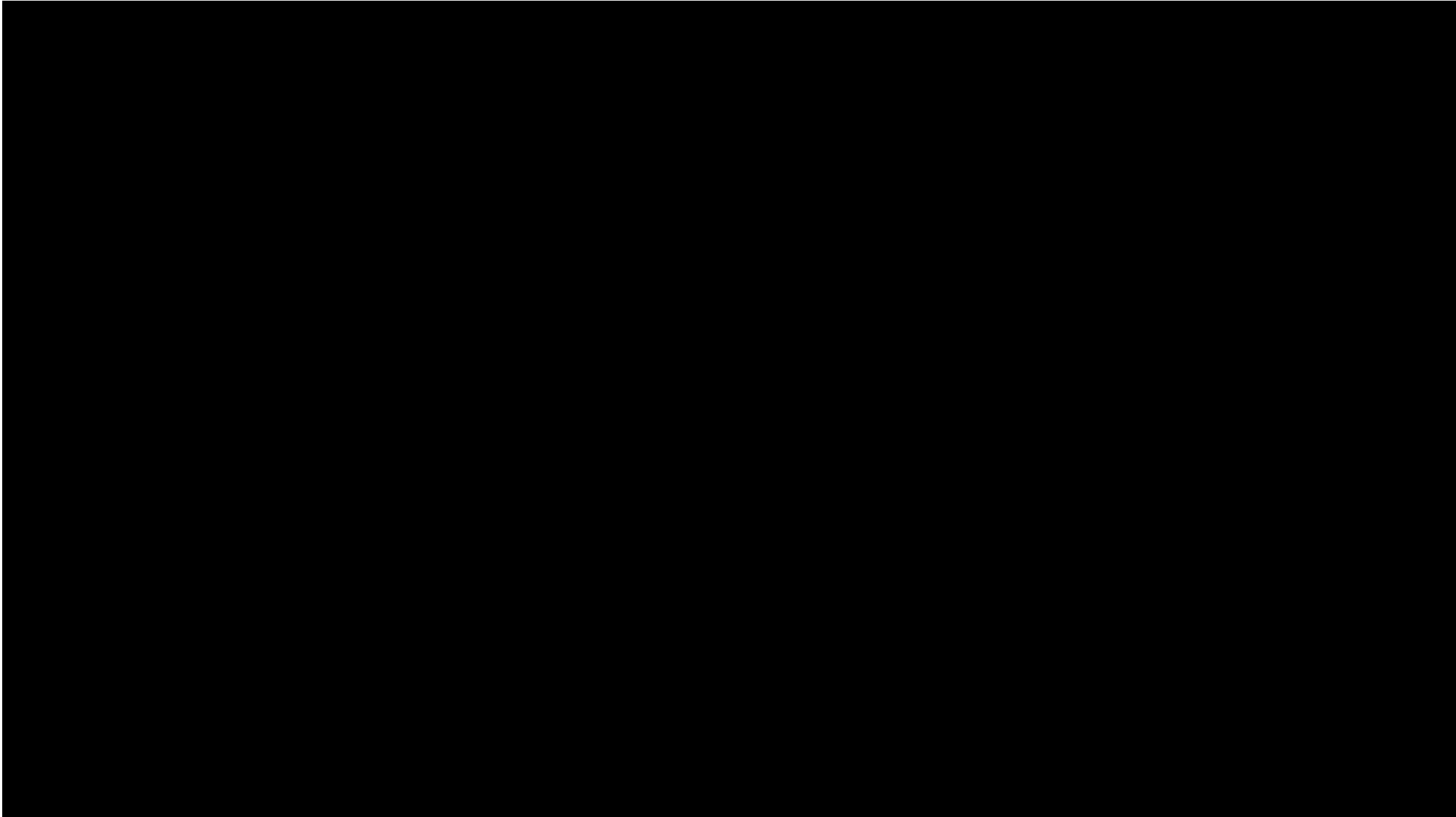

Features



Fan and heater assembly are configured so that the entire assembly is thin enough to fit inside a standard 2x4 wall.

View from back side

Features

PLEASE DONT DO THIS AT HOME!



Pegs are mounted in an aluminum channel, bolted securely to the face that provides robust support, well beyond what typical peg dryers provide.

Features

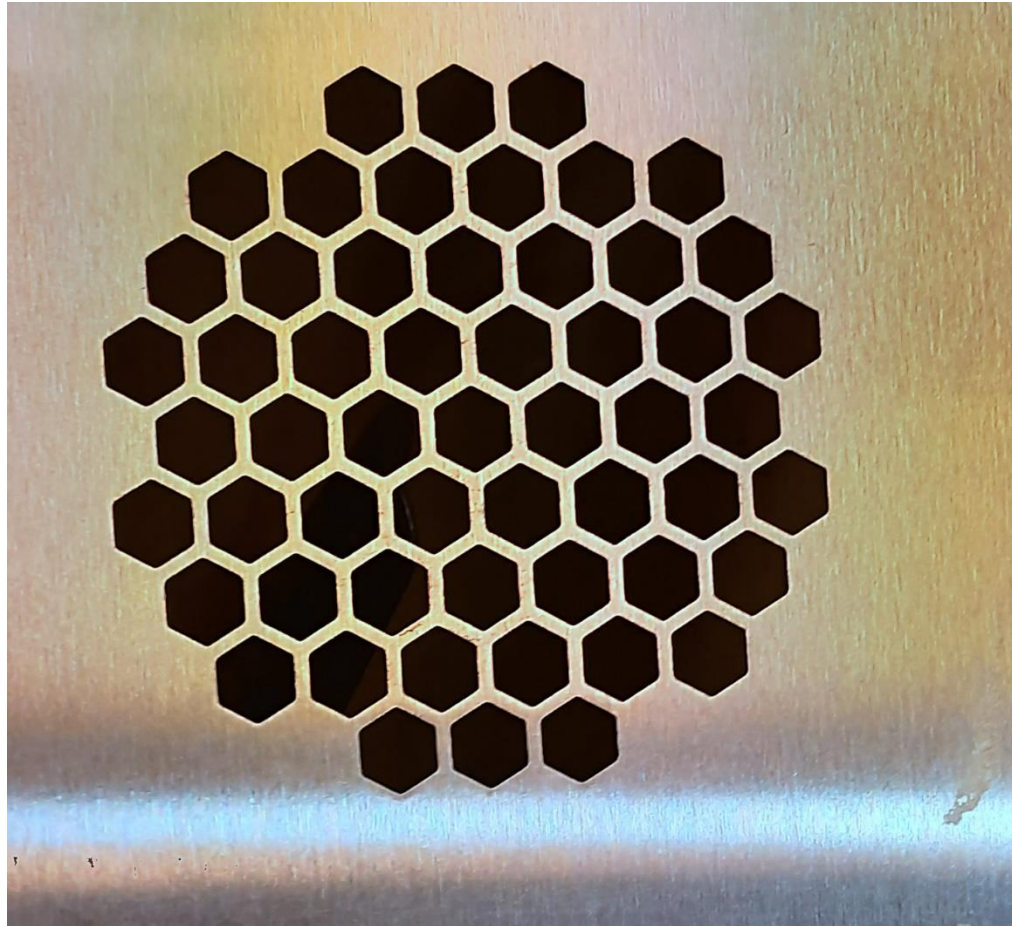

When Home is More Than a Locker Room™

- Face plate is laser cut for clean neat edges.
- Air inlet grill has efficient hexagon shape holes.
- Edges are rolled to avoid sharp corners

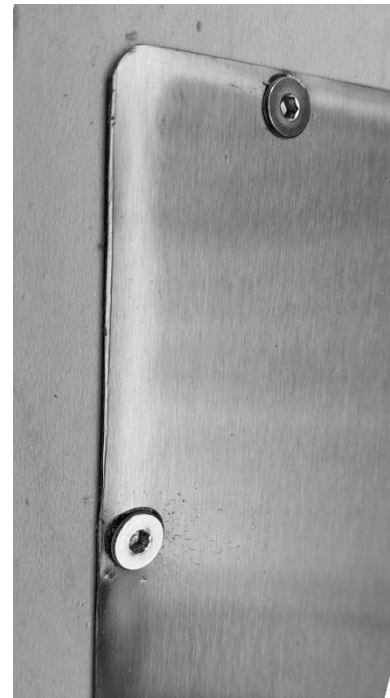

Features



When Home is More Than a Locker Room[™]

- Temperature of air is controlled to a maximum of 120F to avoid damage to boots.
- A moderated temperature with longer dry time is better for boots.
- 4 to 8 hours is ample time for overnight drying and warming up boots for the day is easily accomplished during breakfast.
- Timer supplied is Intermatic EI220 1,2,4,8 Hours
- An illuminated switch for turning heat on and off is included.

Options

- Standard models include 2, 4, and 7 Pair.
- Custom models of 9 or 12 pair can be combined for larger installations.

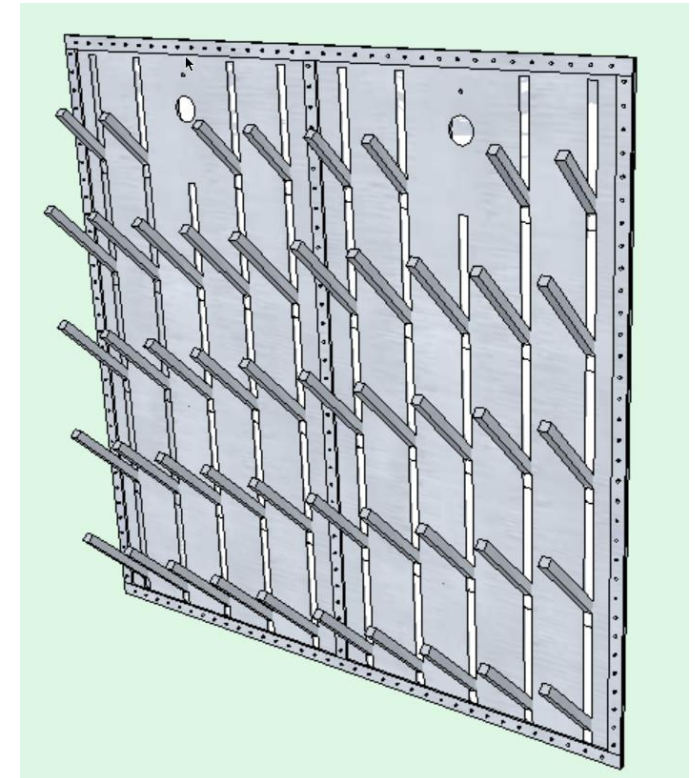
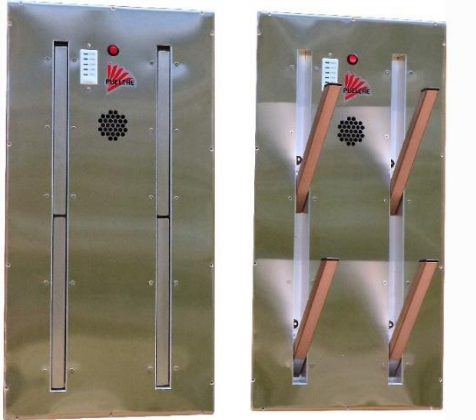

Options

Surface treatment:

- Brushed Stainless Steel
- Powder coat painted

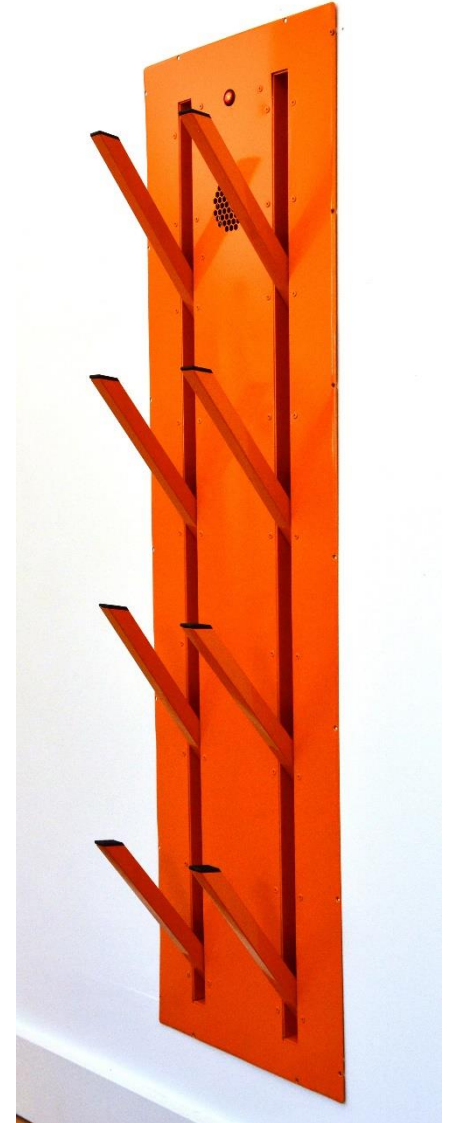
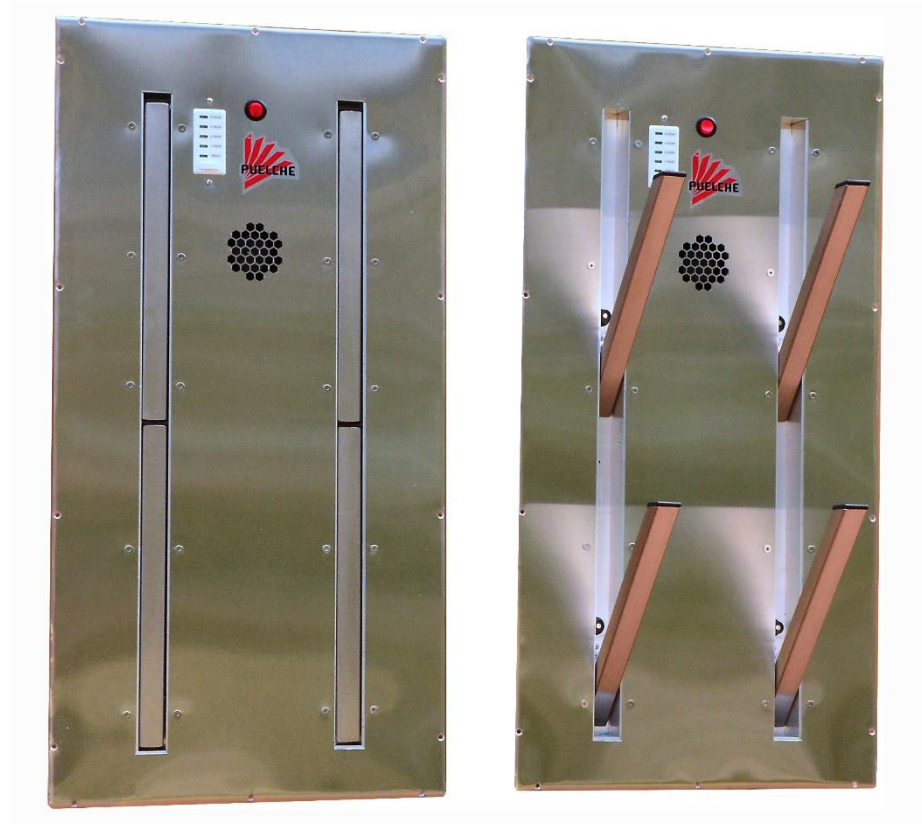

Options

Custom Face Materials

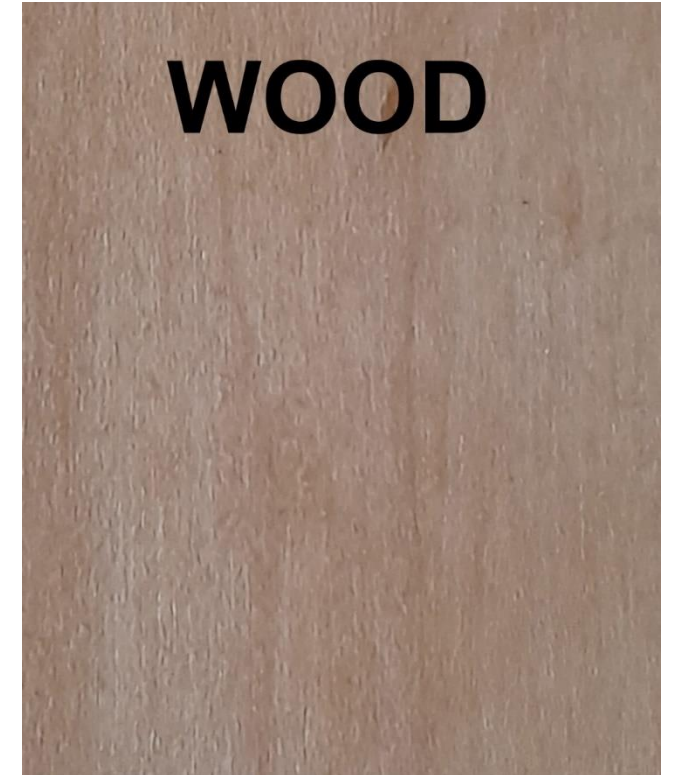
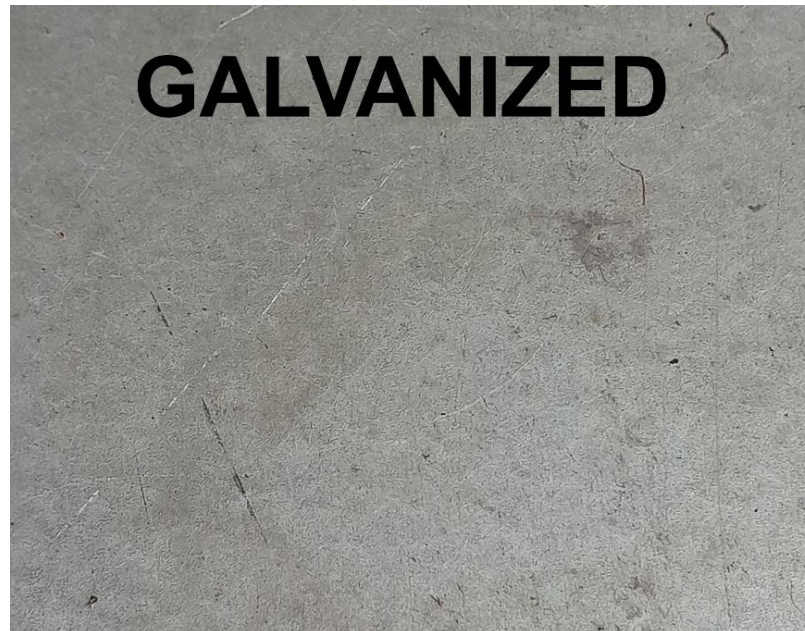

Options

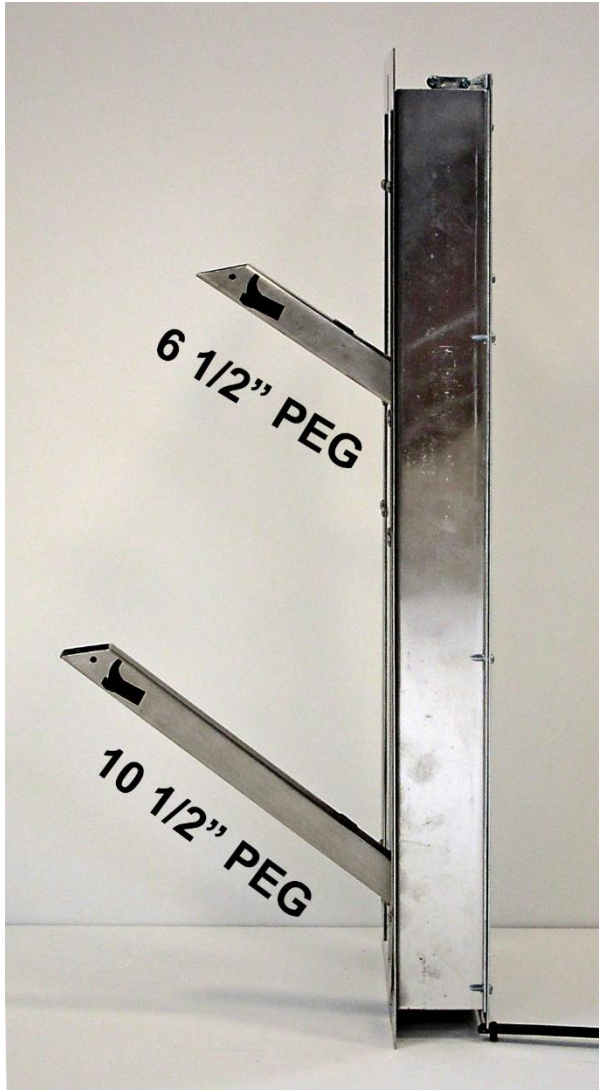

Peg Options

- Standard Pegs for boots are 10 ½.
 - Vertical spacing: 13"
- Optional short pegs for gloves, hats, helmets are 6 ½"
 - Vertical spacing: 8"

Options



Boot Tip: 45 degree plastic tip directing air toward toe of boot

Peg Tip Options



Glove Tip: Contoured plastic tip and multiple holes on 3 or 4 sides of upper section of peg for better air distribution inside glove or helmet

Options

Optional glove spreader for better glove / helmet drying



Other Products From Puelche[™] Dryer

Other Products



Two and Four pair dryers for wall mounting

- Plug into wall socket.
- Timer mounted on face.
- Heat On switch and indicator (Red).

Other Products

Dryer chest

- Plugs into wall outlet with extension cord.
- Remote control timer.



Other Products

Team Travel Dryer

- 16 pair.
- High flow warmed air.
- Retracting power cord.
- Heavy duty pneumatic wheels.
- Pulling handle.
- Optional storage compartment.
- Timer and fan speed control.



Other Products



Team Travel Dryer

- 8 pair.
- High flow warmed air.
- Detachable power cord stows in internal compartment.
- Heavy duty rubber wheels.
- Pulling handle.
- Travel cover
- Countdown timer.
- Heat on / off switch

Other Products



Wader Dryer

- In-The-Wall or On-The-Wall.
- Peg extends to 48"

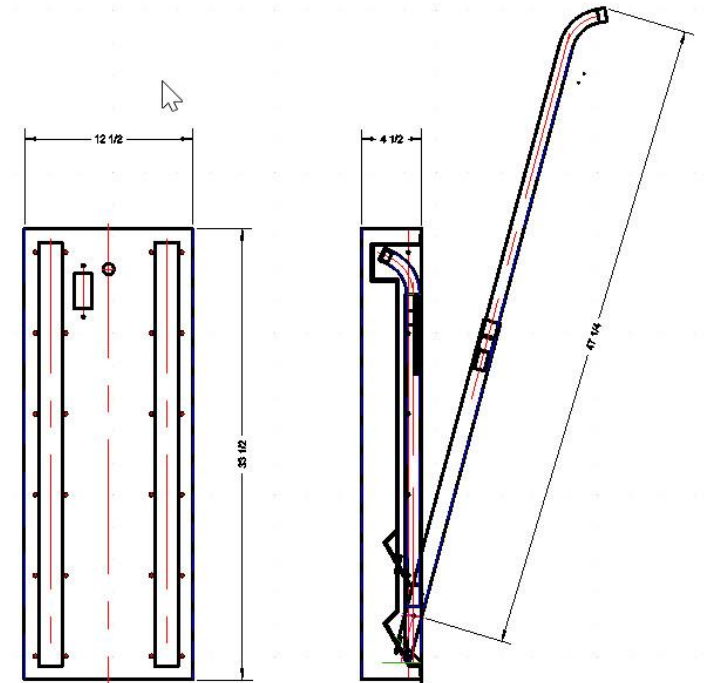

Other Products / prototypes

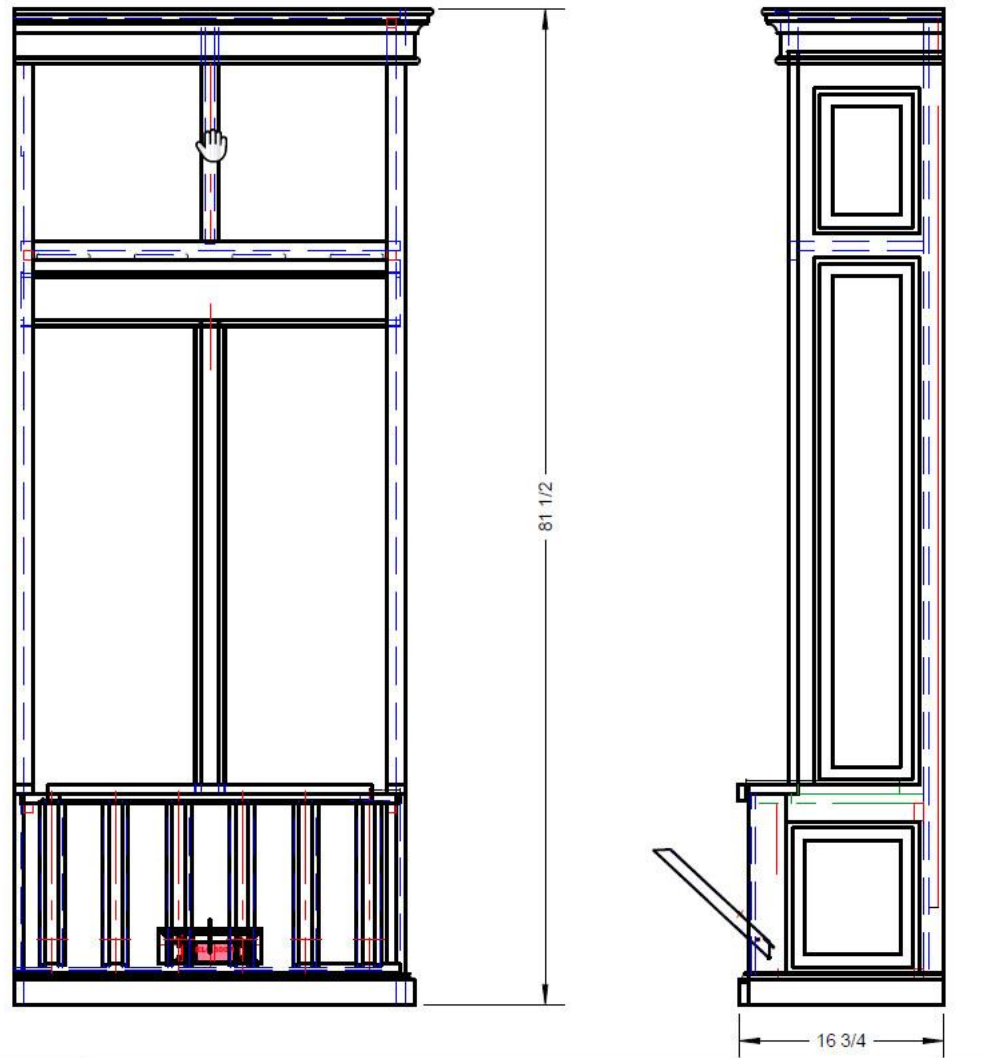

Mudroom Locker or Team Room Locker

- 2 pair to 4 pair per section.
- Plugs into wall or have common plenum for multiple units.
- Timer with remote control.
- Customizable.

Other Products / prototypes

2 Pair Travel Dryer

- Plugs into wall socket.
- Remote control timer.
- 8 pair portable in development.



**All Puelche™ Boot Dryer products are protected by US patents:
10,197,332 & 10,718,565 & 10,961,655
Canada and other foreign patents pending.**

US 2019020551A1

(15) **United States**
(12) **Patent Application Publication** (10) **Pub. No.:** US 2019/020551 A1
Hinkey (43) **Pub. Date:** Apr. 25, 2019

(54) **METHODS OF DRYING APPAREL AND APPAREL DRYING ASSEMBLIES** (52) **U.S. CL.** F26B 9/00 (2013.01)
CPC

(71) **Applicant:** Lawrence A. Hinkey, Glens Falls, NY (US)

(72) **Inventor:** Lawrence A. Hinkey, Glens Falls, NY (US)

(21) **Appl. No.:** 16/227,757

(22) **Filed:** Dec. 20, 2018

Related U.S. Application Data
(63) Continuation-in-part of application No. 15/195,250, filed on Jan. 28, 2016, now Pat. No. 10,197,332.

Publication Classification
(51) **Int. Cl.** F26B 9/00 (2006.01)

ABSTRACT
Assemblies and methods for drying apparel, for example footwear or gloves, are provided. The assemblies include a panel, projections or pegs pivotally mounted to the panel, the projections each having an inlet, an outlet, an internal passage communicating the inlet to the outlet, and the projections can be oriented in a position adapted to receive the apparel, and a source of air having an outlet in fluid communication with the inlets of the projections. The air, for example, from a fan, passes into the inlets of the projections, through the internal passages, and out of the outlets to contact and dry the apparel mounted on the projections. The methods may include heating the air to enhance the drying. Projection modules that can be pivotally mounted to extend and retract into the panel are also disclosed. The retracted projection may be flush with the panel when not in use.

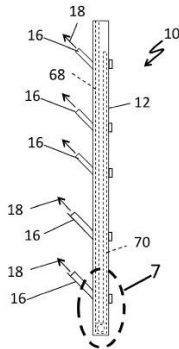

US 10718565 B2

(12) **United States Patent**
Hinkey (45) **Date of Patent:** Jul. 21, 2020

(54) **METHODS OF DRYING APPAREL AND APPAREL DRYING ASSEMBLIES** (52) **U.S. CL.** F26B 9/00 (2013.01)
CPC

(71) **Applicant:** Lawrence A. Hinkey, Glens Falls, NY (US)

(72) **Inventor:** Lawrence A. Hinkey, Glens Falls, NY (US)

(*) **Notice:** Subject to any disclaimer, the term of this patent is extended or adjusted under 35 U.S.C. 154(b) by 0 days.

(21) **Appl. No.:** 16/227,757

(22) **Filed:** Dec. 20, 2018

(65) **Priority Publication Data**
US 20180120551 A1 Apr. 25, 2019
Related U.S. Application Data
(63) Continuation-in-part of application No. 15/195,250, filed on Jan. 28, 2016, now Pat. No. 10,197,332.

(51) **Int. Cl.** F26B 9/00 (2006.01); F26B 21/00 (2006.01)

(52) **U.S. CL.** F26B 9/00 (2013.01); F26B 21/006 (2013.01)

(58) **Field of Classification Search**
CPC — F26B 9/00; F26B 9/10; F26B 21/006; F26B 21/006; A43D 95/04; A43D 95/04; A47L 22/205; D06F 59/04; D06F 59/06
USPC — 34/90, 427
See application file for complete search history.

(56) **References Cited**
U.S. PATENT DOCUMENTS
1,074,888 A 10/013 Meier
2,445,695 A 6/288 Russell

(47) **Notice:** Subject to any disclaimer, the term of this patent is extended or adjusted under 35 U.S.C. 154(b) by 0 days.

FOREIGN PATENT DOCUMENTS
CA 2801681 A1 7/2011
DE 282792 A1 6/1988 (Continued)

OTHER PUBLICATIONS
International Search Report from corresponding PCT application PCT/US2017/039501, dated Aug. 6, 2017, 3 pages. (Continued)

Primary Examiner: Stephen M Gravit
(74) **Attorney, Agent or Firm:** Jack Valley Patent, LLC, John Pietrangolo

(57) **ABSTRACT**
Assemblies and methods for drying apparel, for example footwear or gloves, are provided. The assemblies include a panel, projections or pegs pivotally mounted to the panel, the projections each having an inlet, an outlet, an internal passage communicating the inlet to the outlet, and the projections can be oriented in a position adapted to receive the apparel, and a source of air having an outlet in fluid communication with the inlets of the projections. The air, for example, from a fan, passes into the inlets of the projections, through the internal passages, and out of the outlets to contact and dry the apparel mounted on the projections. The methods may include heating the air to enhance the drying. Projection modules that can be pivotally mounted to extend and retract into the panel are also disclosed. The retracted projection may be flush with the panel when not in use.

10 Claims, 18 Drawing Sheets

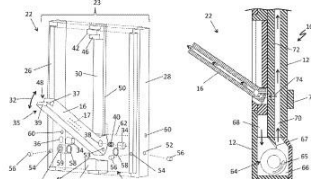

(12) INTERNATIONAL APPLICATION PUBLISHED UNDER THE PATENT COOPERATION TREATY (PCT)

(19) **World Intellectual Property Organization**

(43) **International Publication Date** 04 January 2018 (04.01.2018)

(11) **International Publication Number** WO 2018/005490 A1

(54) **International Patent Classification:** A47L 23/20 (2006.01); F26B 21/00 (2006.01); D06F 59/06 (2006.01); A43D 95/10 (2006.01)

(21) **International Application Number:** PCT/US2017/039501

(22) **International Filing Date:** 27 June 2017 (27.06.2017)

(25) **Filing Language:** English

(26) **Publication Language:** English

(30) **Priority Data:** 53195-250 28 June 2016 (28.06.2016) US

(72) **Inventor:** and
(71) **Applicant:** HINKEY, Lawrence, A. (US); 5 Grove Avenue, Glens Falls, NY 12801 (US).

(74) **Agent:** PIETRANGOLO, John, Tech Valley Patent, LLC, 499 Glen Street, Glens Falls, NY 12801 (US).

(81) **Designated States (unless otherwise indicated, for every kind of national protection available):** AE, AG, AL, AM, AO, AT, AU, AZ, BA, BB, BG, BH, BR, BW, BY, BZ, CA, CH, CL, CN, CO, CR, CU, CZ, DE, DK, DM, DO, DZ, EC, EG, ES, FI, GB, GD, GE, GR, GT, HN, HR, HU, ID, IL, IN, IR, IS, JP, KE, KG, KH, KN, KP, KR, KW, KZ, LA, LC, LK, LR, LS, LU, LY, MA, MD, ME,

(54) **Title:** APPAREL DRYING ASSEMBLIES AND METHODS OF DRYING APPAREL

(57) **Abstract:** Assemblies (10) and methods for drying apparel, for example footwear or gloves, are provided. The assemblies (10) include a panel (12), projections or pegs (14, 16) pivotally mounted to the panel, the projections each having an inlet (18), an outlet (20), an internal passage (17) communicating the inlet to the outlet, and the projections (14, 16) can be oriented in a position adapted to receive the apparel; and a source of air (64) having an outlet in fluid communication with the inlets (18) of the projections (14, 16). The air, for example, from a fan, passes into the inlets (18) of the projections (14, 16), through the internal passages (17), and out of the outlets (20) to contact and dry the apparel mounted on the projections (14, 16). The methods may include heating the air to enhance the drying. Projection modules (22) that can be pivotally mounted to extend and retract into the panel (12) are also disclosed. The retracted projection may be flush with the panel when not in use.

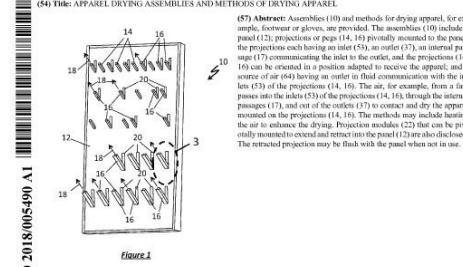

WO 2018/005490 A1



Contact

When Home is More Than a Locker Room™

Contact:

www.PuelcheBootDryer.com

larry@Corlear.com

518 793 6946

PO Box 697
Glens Falls NY 12810