



ARCHITECTURAL HARDWARE SYSTEMS

STERLING
ENTRY
SYSTEMS

CONTENT

Architectural Hardware

Patch Fitting / Bottom Rail	:	AH1-AH7
Locks	:	AH8-AH12
Glass Door Handles	:	AH13-AH15
Sliding Systems	:	AH16-AH30
Washroom Partition	:	AH31
Door Stoppers	:	AH32
Commercial Channels	:	AH33

Glazing & Canopy

Pool Fencing

Tools & Accessories



26100 Self Closing Bottom Patch



EN1154 TESTED

Power Adjustable Hydraulic Bottom Patch

Requires no digging or cutting of floor, quick and easy installation with just four fasteners.

- Suitable door weight : Max 100kg. (220 Lbs)
- Suitable door width : 750~1000mm (29 17/32"-39 3/8")
- Suitable door thickness : 8~13mm (5/16"- 15/32")
- Ambient temperature : -20°C to +50°C

Hold open 90° (Non Hold Open also available)
 Easy installation with base seat adjustable: ±3mm backward and forward, ±3mm left and right and ±4° alignment adjustment
 Compliance With EN 1154 Tested and UL Certified
 Available with SS 304/316 Cover

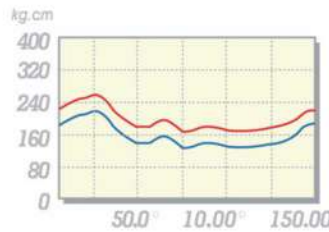
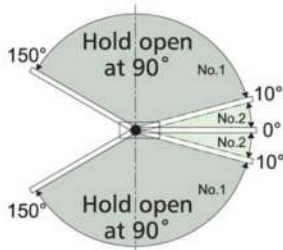
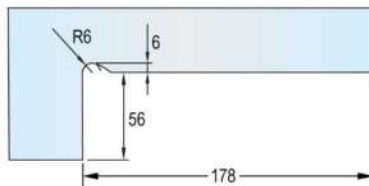
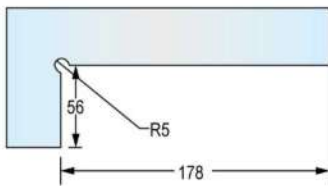
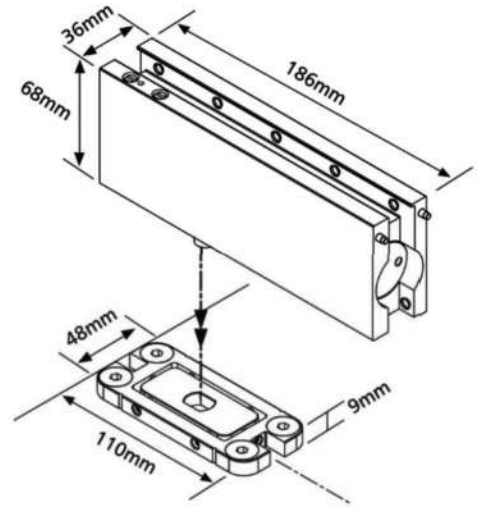
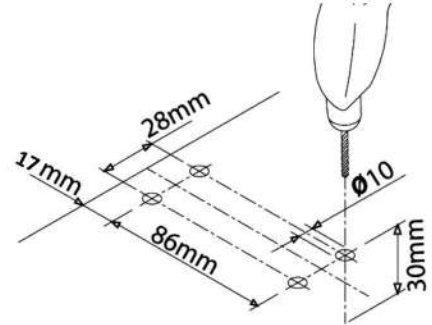

Shown curves refer to PDC103W

Available Finishes



CH BN MB MG SA

Kit includes : Bottom Patch + Top Patch + Pivot



26105 Self Closing Bottom Patch

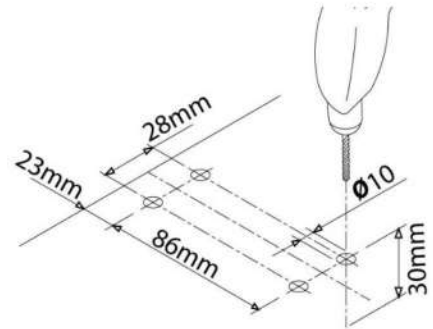

EN1154 TESTED

Power Adjustable Hydraulic Bottom Patch

Requires no digging or cutting of floor, quick and easy installation with just four fasteners

- Suitable door weight : Max 100kg. (220 Lbs)
- Suitable door width : 750~1000mm (29 17/32"- 49 7/32")
- Suitable door thickness : 10~13mm (5/16"- 19/32")
- Ambient temperature : -20°C to +50°C

Hold open 90° (Non Hold Open also available)
 Easy installation with base seat adjustable: ±3mm backward and forward, ±3mm left and right and ±4° alignment adjustment
 Available with SS 304/316 Cover

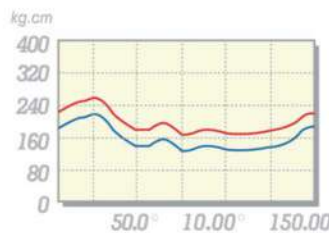
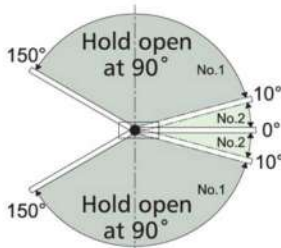
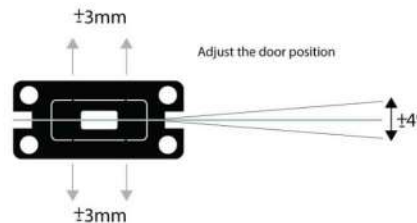
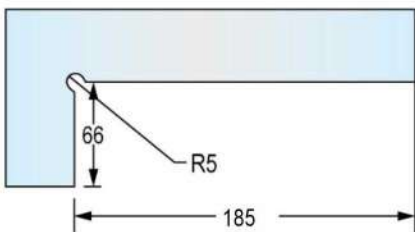
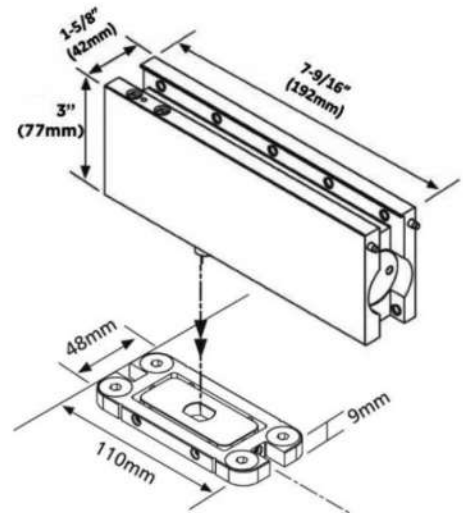

Shown curves refer to PDC103W



Available Finishes



26135 Self Closing Bottom Patch

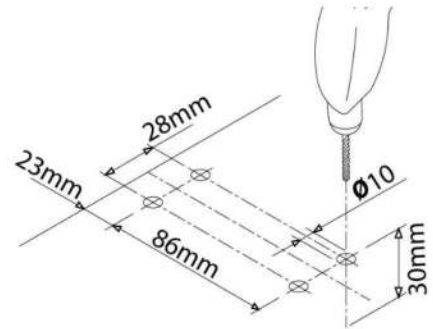

EN1154 TESTED

Power Adjustable Hydraulic Bottom Patch

Requires no digging or cutting of floor, quick and easy installation with just four fasteners

- Suitable door weight : Max 100kg. (220 Lbs)
- Suitable door width : 750~1250mm (29 17/32"- 49 7/32")
- Suitable door thickness : 10~15mm (25/64"- 19/32")
- Maximum opening : 150°
- Controlled : 135°
- Ambient temperature : -20°C to +50°C

Hold open 90° (Non Hold Open also available)
 Easy installation with base seat adjustable: ±3mm backward and forward, ±3mm left and right and ±4° alignment adjustment
 Available with SS 304/316 Cover

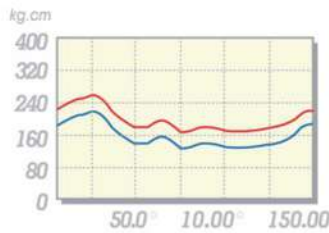
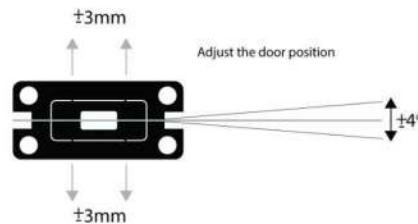
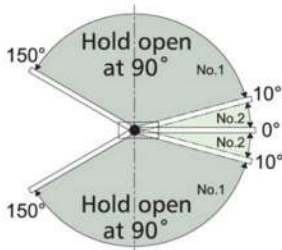
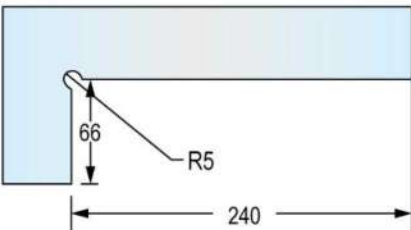
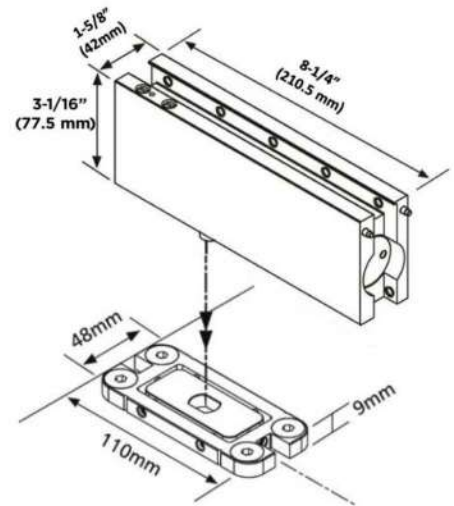

Shown curves refer to PDC103W

Available Finishes



26600



With variable pivot point of 55 or 65mm (2 11/64" or 2 19/32")

Door Rail System with Inbuilt Lock & Hydraulic Patch system for North American Market



- The door held by friction grip (Dry Glazing)
- No need of glass preparation
- Glass Size: Suitable for 12mm~15mm (15/32"~19/32")
- Comes with American type lock option as well
- Supplied in sets for Top & Bottom
- Cover Grade SS-304 with End Caps
- Bolts from opposite sides make unauthorized removal virtually impossible



Glass door rails offer ease of installation with dependable quality. These pre-assembled mechanical rails have a variety of fabrication options to create a customized solution that fits any glass door application.

Available Finishes



BN MB SA

26201-A OVER PANEL SIDE PANEL
CONNECTING PATCH WITH PIVOT

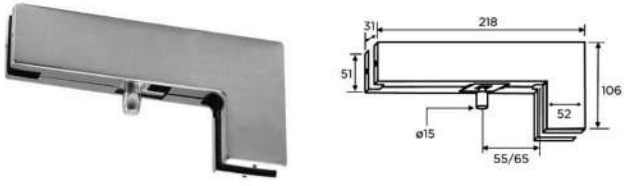

26201-B OVER PANEL SIDE PANEL
CONNECTING PATCH WITH STRIKE INSERT

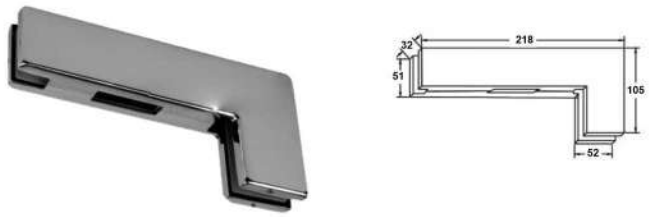

26201-C OVER PANEL SIDE PANEL
CONNECTING PATCH WITH STRIKE
INSERT

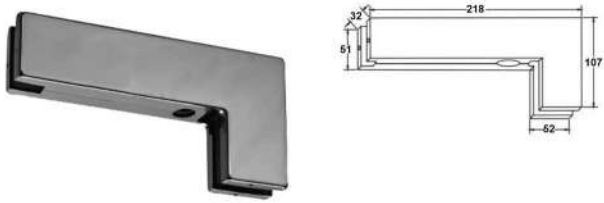

26201-D OVER PANEL DOUBLE DOOR STRIKE

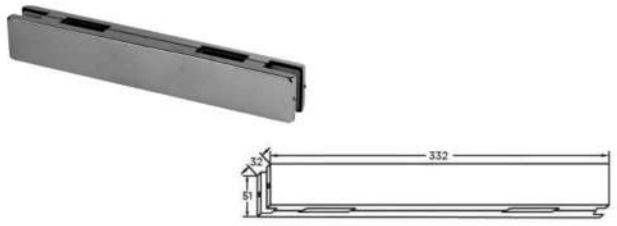

26201-DR OVER PANEL DOUBLE DOOR STRIKE

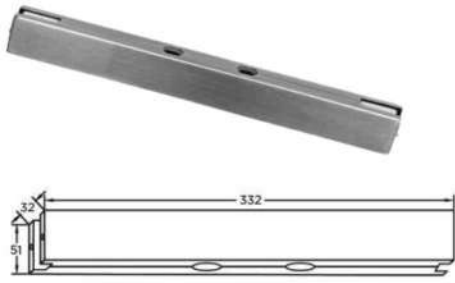

26201-E OVER PANEL DOUBLE DOOR STRIKE

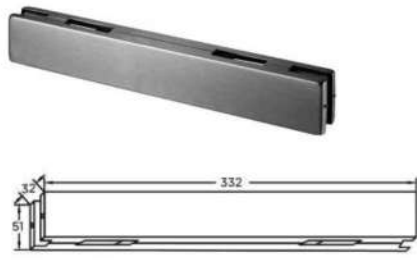

Pivot TOP PIVOT FOR PATCH / POINT
FITTING DOORS

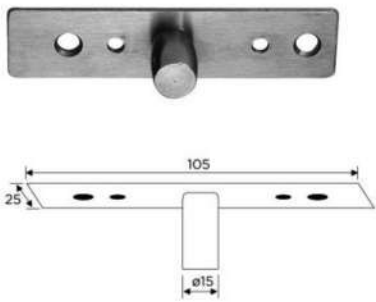

Available Finishes

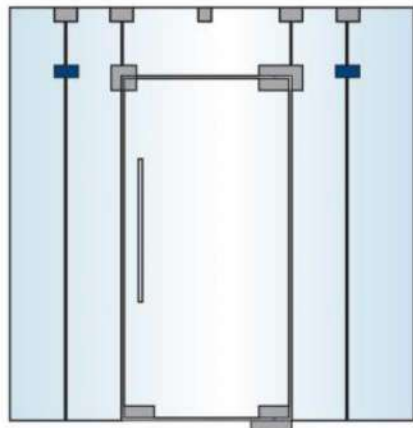

26230-WF DOUBLE GLASS CONNECTOR WITH FIN FITTING INSIDE

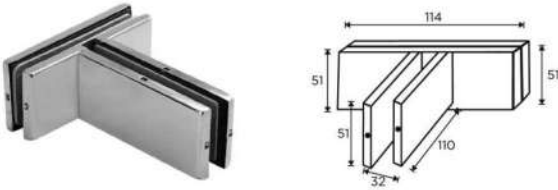

26240

WALL TO GLASS CLAMPING PATCH

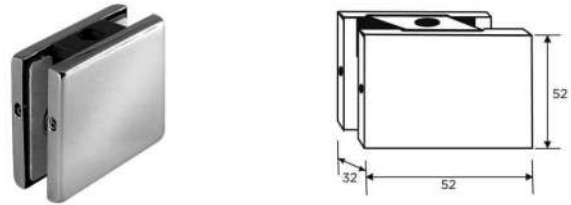

26250

GLASS TO GLASS CONNECTING PATCH TO WALL/CEILING

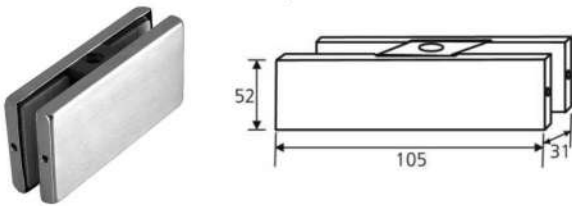

26260

DOUBLE GLASS CONNECTOR

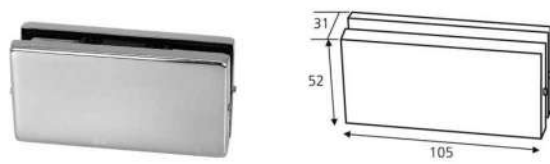

26241-WF-L/R

OVER PANEL SIDE PANEL CONNECTOR WITH FIN FITTING (RIGHT/LEFT)

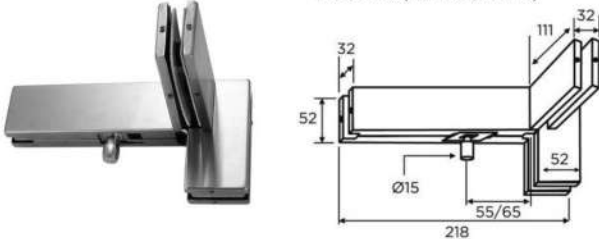

26201-T

OVER PANEL CONNECTOR FOR BACK TO BACK DOORS

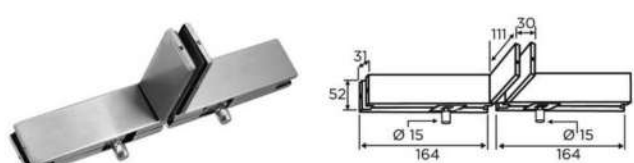

26600
APF4000

DOOR RAIL



26600
APF5000

SIDE PANEL RAIL



26600
APF5000-1

SIDE PANEL UPPER RAIL



26600
APF5000-2

SIDE PANEL LOWER RAIL



26600
APF3000

DOOR RAIL WITH LOCK



26600
APF6000

SIDE PANEL RAIL



26606
MINI BASE SHOE- 10ft
(with 10 clamps & cladding)



Available Finishes



26202

TOP PATCH VARIABLE PIVOT POINT OF 55 TO 65MM AVAILABLE WITH SS 304/316 COVERS

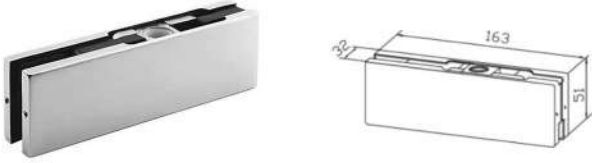

26203

BOTTOM PATCH

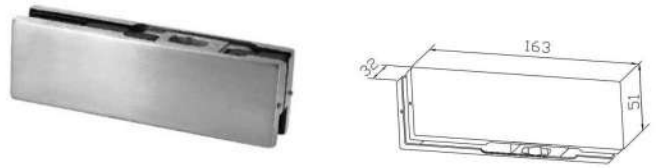

26204

WALL MOUNTED OVER PANEL PATCH WITH PIVOT

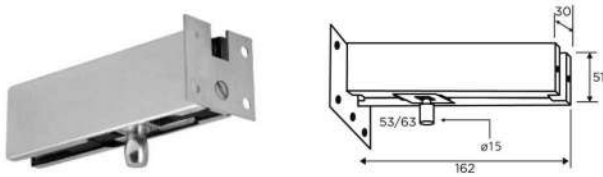

26210

OVER PANEL SIDE PANEL CONNECTOR



26210-DST

OVER PANEL SIDE PANEL CONNECTOR WITH STOPPER



26211

CORNER PATCH LOCK WITH STRIKE PLATE (AMERICAN CYLINDER)

One Side Key, One Side Knob



With dust keeper

26220

QUADRUPLE CONNECTOR

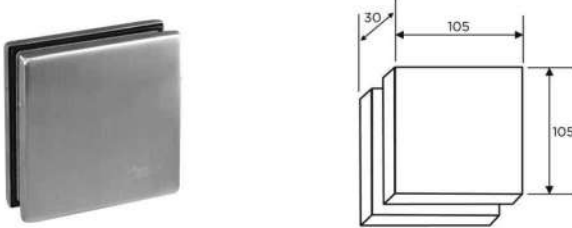

26220-WF

QUADRUPLE CONNECTOR WITH FIN

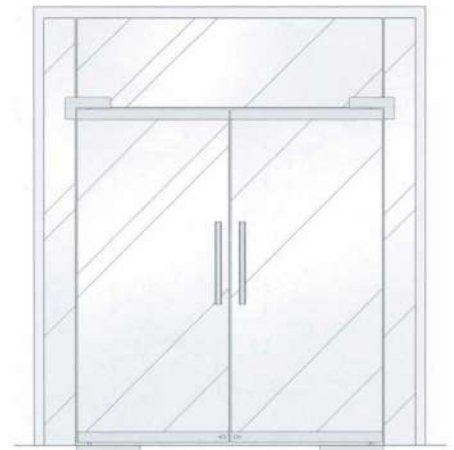
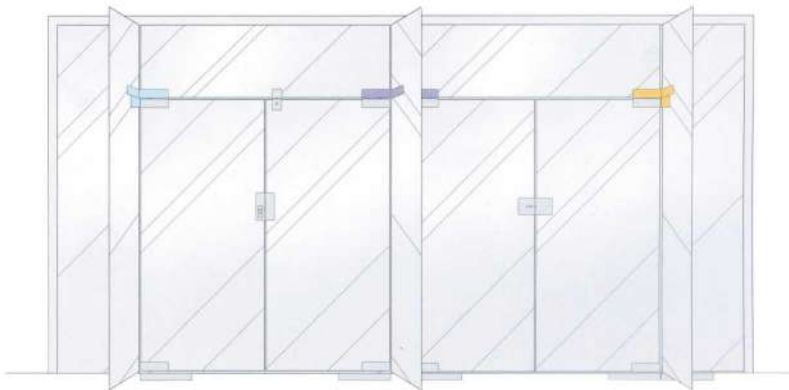
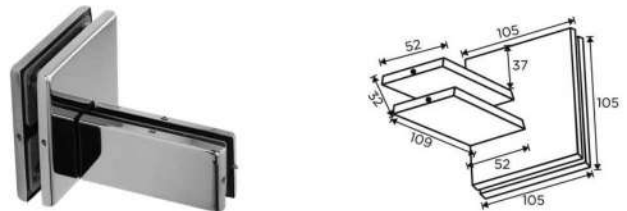

Available Finishes

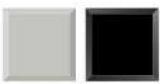

BN MB



ARCHITECTURAL HARDWARE SYSTEMS

**LOCKS
&
HANDLES**

70001/70002



PREMIUM ARCHITECTURAL LOCKS

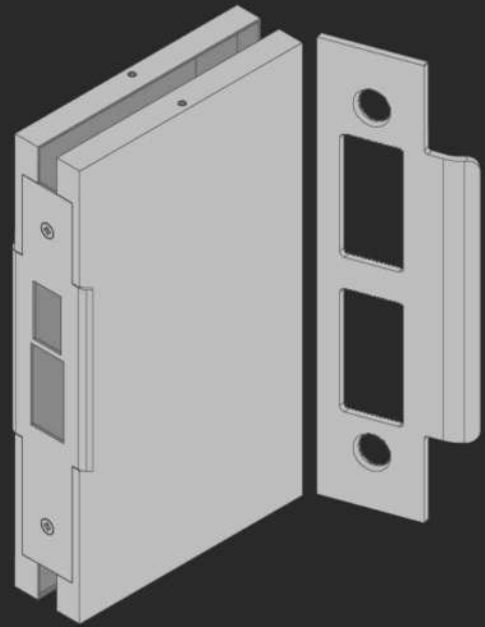

70003/70004

Left Hand Operation/Right Hand Operation-Available
To be Mentioned Before Ordering

Glass Door Lock Is For Swing Door; Suitable For Public And Commercial Buildings. With ANSI Grade 1 Lockcase And Lever Handle, Different Lockcase Function Available To Suit For Different Project Requirement. Suitable For Glass To Glass & Glass To Wall Installation With Stainless Steel Door Handle And Lockcase Cover, Suitable For Most Commercial Project Requirement.

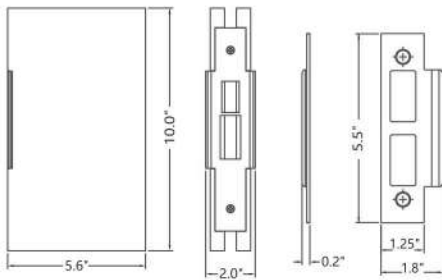

70001LH-BN/MB - Left Hand Brush Nickel/Matt Black
70002RH-BN/MB - Right Hand Brush Nickel/Matt Black

70003 BN - Keeper Brush Nickel
70004 American Cylinder Assembly ANSI



Available Finishes



- ENTRANCE
- OFFICE
- STORE ROOM
- CLASSROOM
- PASSAGE

ELECTRIC STRIKE AVAILABLE-ASK YOUR SALES CONSULTANT

71001R-LHBN STANDARD DUTY MECHANICAL LOCK GLASS TO GLASS/WALL



71001SDL-BN STANDARD DUTY MECHANICAL LOCK GLASS TO GLASS/WALL



71001R-LHMB STANDARD DUTY MECHANICAL LOCK GLASS TO GLASS/WALL



71001SDL-MB STANDARD DUTY MECHANICAL LOCK GLASS TO GLASS/WALL



71101-LHBN/MB STANDARD DUTY MECHANICAL LOCK GLASS TO GLASS/WALL
71101-RHBN/MB FULL SWING BOTH SIDE



71101HSL-BN/MB STANDARD DUTY MECHANICAL LOCK GLASS TO GLASS/WALL HALF SWING SINGLE SIDE



71103 ARCHITECTURE HINGES & LOCK COMBO

71103-1



71103-2-BN



71103-2-MB



Available Finishes



BN MB

71102HSL-BN/MB STANDARD DUTY MECHANICAL LOCK GLASS TO GLASS/WALL



71104 GLASS DOOR LOCK WITH STRIKE BOX



71105 GLASS DOOR LOCK WITH STRIKE PLATE



71106 GLASS DOOR LOCK WITH STRIKE BOX



71107 THUMB TURN LOCK & STRIKE BOX



71108

71109

71110 GLASS DOOR LOCK WITH STRIKE BOX (WITH INDICATOR)



71111 CENTRE PATCH LOCK VERTICAL



71102WIHS-LH

STANDARD DUTY MECHANICAL LOCK GLASS TO GLASS/WALL (WITH INDICATOR & MAGNETIC STRIKE PLATE) SINGLE SIDE OPERATION



Available Finishes



BN MB

71112 GLASS DOOR LOCK WITH STRIKE BOX/PLATE



70000 Series

STERLING KEYLESS
GO SECURE
DIGITAL LOCK

LOCKS & HANDLES



FINGERPRINT/KEY CODE/CARD ACCESS

NO GLASS FABRICATION
REQUIRED

FOR 10-12MM GLASS

BATTERY OPERATED

BATTERY LIFE UP TO ONE
YEAR, LOW POWER
INDICATOR AND
EMERGENCY POWER PORT
ACCESS

ANTI THEFT ALARM FUNCTION
(AFTER 5 INCORRECT ERRORS
ALARM SOUNDS)



Applications:

- Residential Apartment
- Libraries
- Offices Entrance
- High Security Premises



CALL US IN CASE YOU REQUIRE HELP FOR SETUP

LADDER PULL HANDLE WITH LOCK

60084



Available Finishes



BN MB

**Bold &
Elegant look
Suitable for
Large Glass
Doors**

**ANSI Locking
Mechanism**



LOCKS & HANDLES

LADDER PULL LOCKABLE HANDLES

60336R/60448R

60336SQ/60448SQ

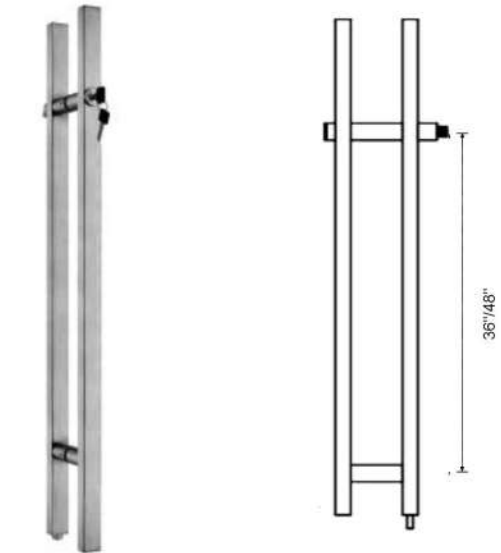
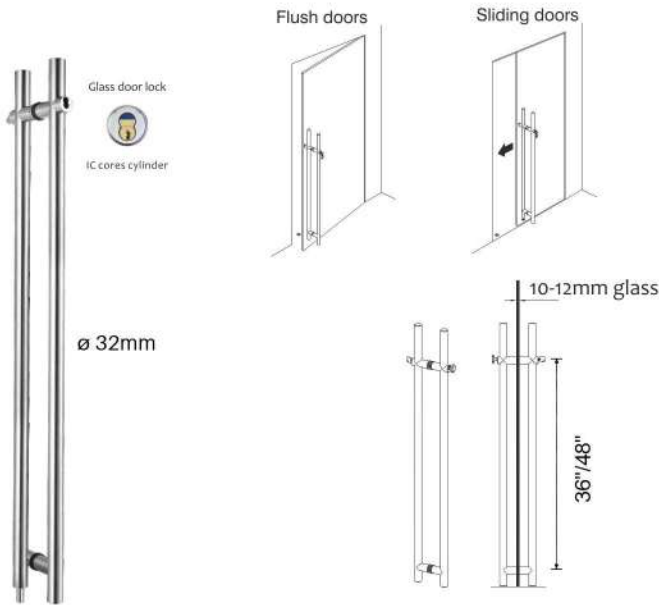

D PROFILE PULL HANDLES

60001-12 }
60001-18 } ø19mm
60001-24 }



LADDER PULL HANDLES SQ PROFILE

60076-12
60076-18
60076-24

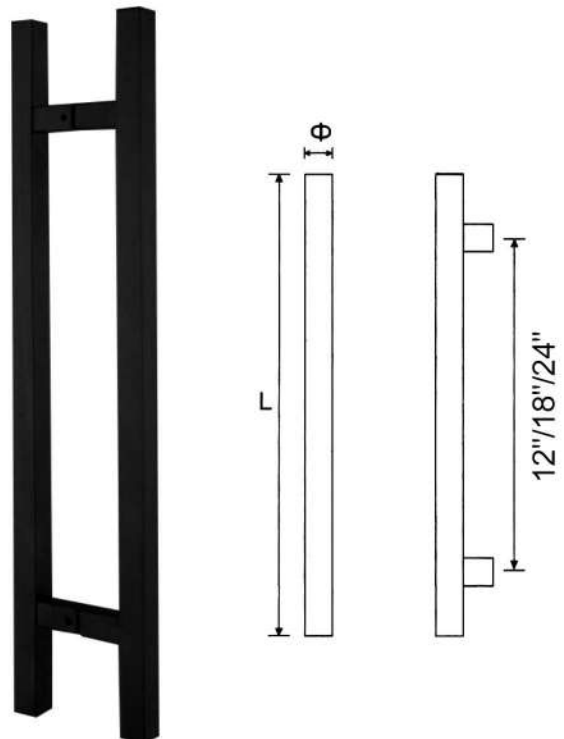

LADDER PULL HANDLES

60006-12 }
60006-18 } ø19mm
60006-24 }
60006-36 } ø32mm
60006-48 }
60006-60 }
60006-72 }

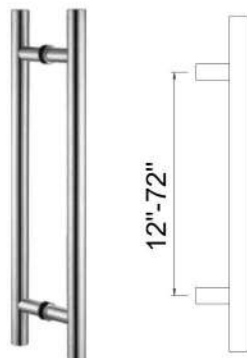

Available Finishes



ARCHITECTURAL SLIM LINE BACK TO BACK HANDLE



60081-12
60081-18
60081-24
60081-36

Chrome Finish

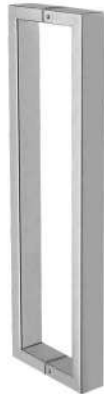

Brushed Nickel Finish



Matte Black Finish

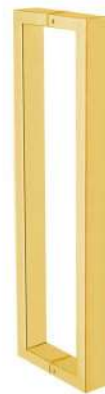

Matt Gold Finish

S PROFILE HANDLE

60005S-18
60005S-24

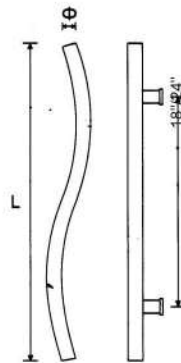

D PROFILE OFFSET HANDLE

60003-18
60003-24

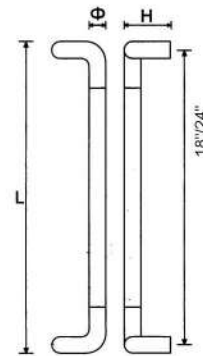

45° OFFSET LADDER PULL HANDLE

64524
64536

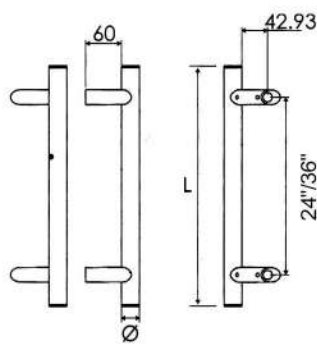
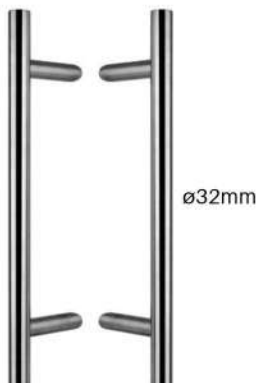

ROYAL WOOD LADDER PULL HANDLE

60003RW-18
60003RW-24

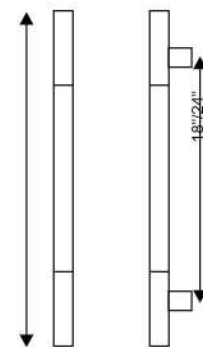

Available Finishes



ALL HANDLES ON PAGE AH13/AH14/AH15 ARE AVAILABLE SINGLE SIDE WITH CAP.
MOST HANDLES ARE AVAILABLE FOR WOODEN DOOR APPLICATION.

69000 SERIES



FEATURES:

- Max. Door Leaf Height: 2500mm
- Max. Door Leaf Width: 900mm
- Max. Door Leaf Load: 70kgs



69004
ROLLER FOR GLASS DOOR



69005
GLASS TO GLASS HINGE



69006
WALL TO GLASS HINGE



7111WSP
CENTRAL PATCH
VERTICAL



71107WSP
THUMB TURN LOCK



69002
TRACK TO
GLASS HOLDER



69003
SLIDING HANDLE



69001
TOP TRACK

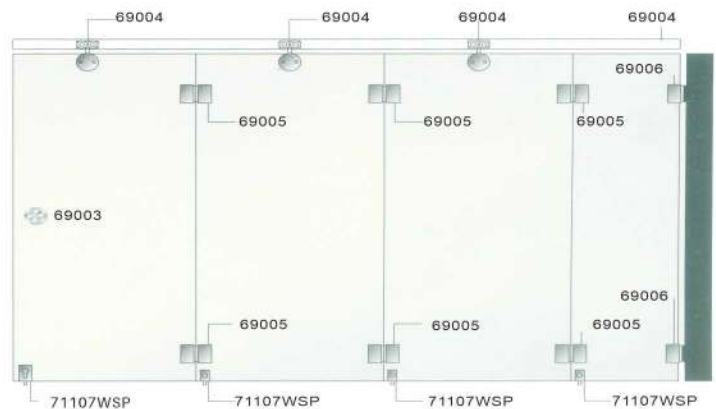
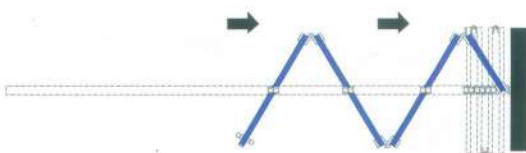

Available Finishes



BN MB

Excellent System Applicable For Diversified Spaces

The relevance degree and practicality of spaces, with the professional design concepts, are brought to the maximum in conformity with different user demands. Not only each piece of spaces finds full use, but the aesthetics, functionality and reliable technology create the effective, economic and multi-shop applicable space. From chain shops, showrooms to shopping malls, hotels and airports, we are sufficient to meet all your Requirements.

69006

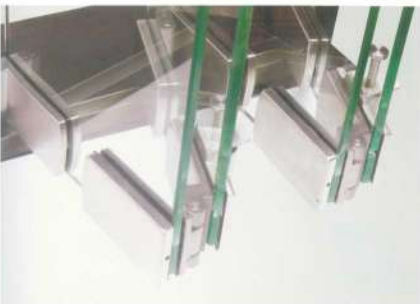
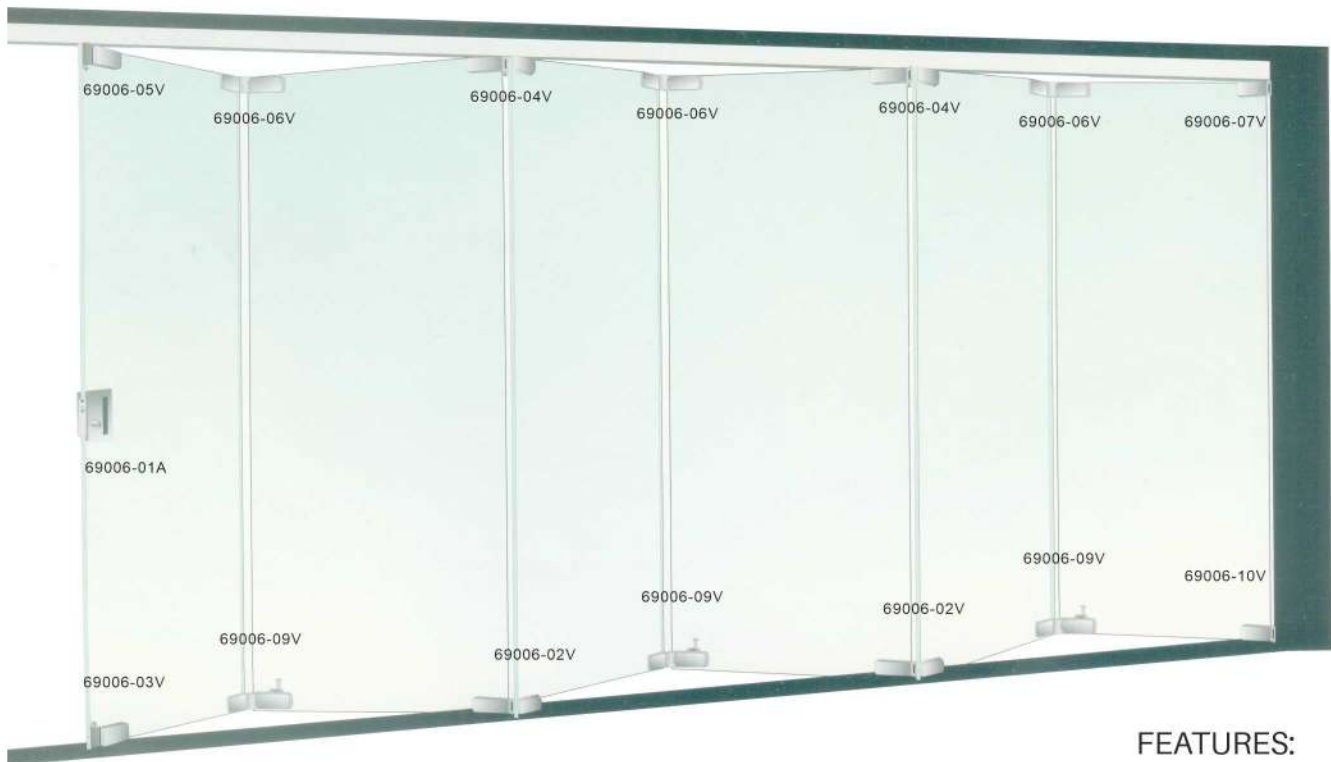

FEATURES:
 Max. Door Leaf Height: 2500mm
 Max. Door Leaf Width: 900mm
 Max. Door Leaf Load: 70kgs



QUALITY

All metal components of the rollers and hinges are stainless steel to hold up to any environment. The rollers ball bearing centers with nylon perimeter to give a lifetime of smooth operation.

The rollers ride in an aluminium track at the top that is anodized bronze. The guide rollers at the bottom of the doors ride in an aluminium track incorporated into the threshold.

PRACTICAL

The system can be locked with a slide bolt or key turn and all components are corrosion resistant and satin silver finish. The hanger wheels are fitted with double sealed precision stainless steel bearings to ensure long life and smooth operation.



SLIDING FOLDING DOOR SYSTEMS

69006 PARTS & ACCESSORIES



69006-01A GLASS TO GLASS DOOR LOCK

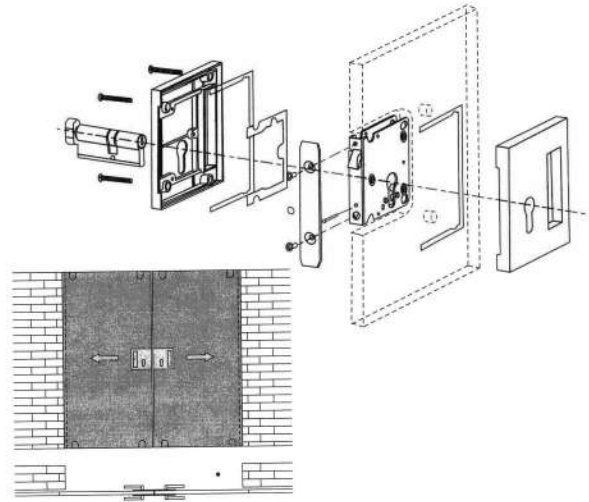

69006-02V GLASS TO GLASS HINGE

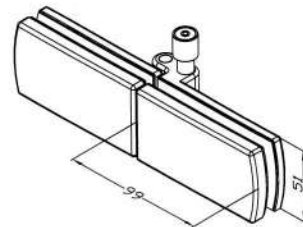

69006-03V BOTTOM GUIDE END PATCH

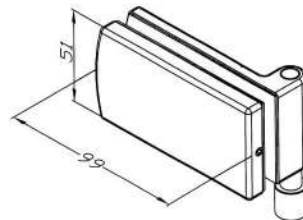

69006-04V GLASS TO GLASS CONNECTOR WITH ROLLER

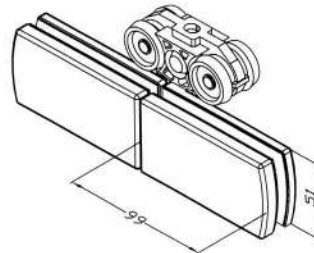

69006-05V END PANEL FITTING WITH ROLLER

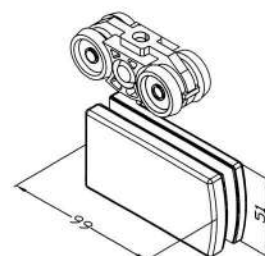



69006-06V

GLASS TO GLASS INTER-CONNECT HINGE

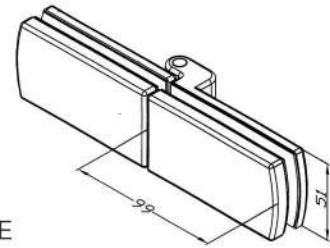

69006-07V

WALL TO GLASS END PANEL HINGE

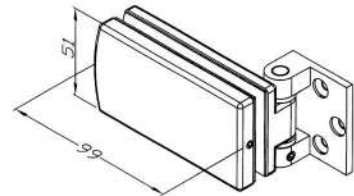

69006-08V

END PANEL FITTING WITH TOP PIVOT

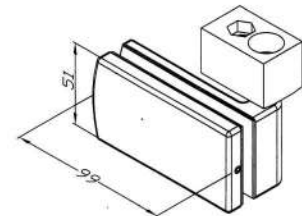

69006-09V

GLASS TO GLASS CONNECTING HINGE WITH FLOOR LOCK

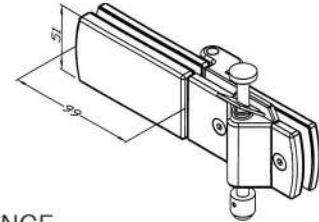

69006-10V

END PANEL FITTING WITH BOTTOM PIVOT

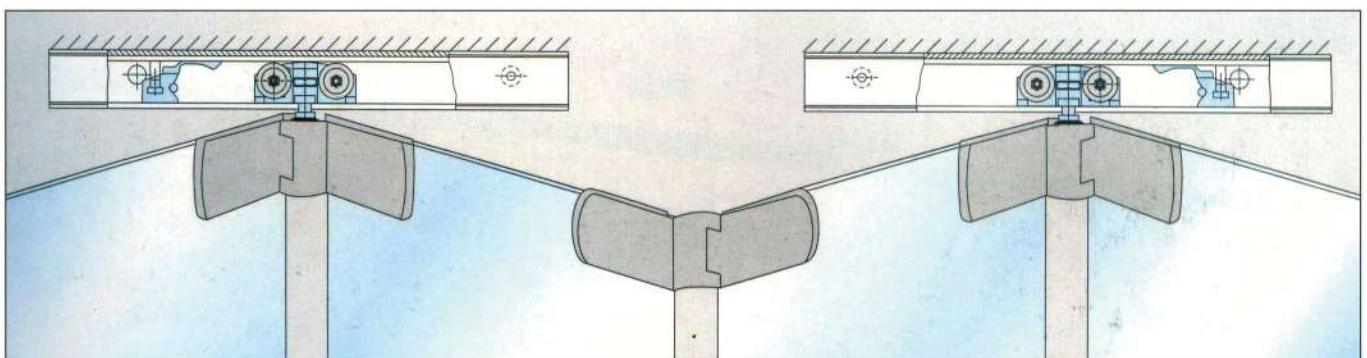
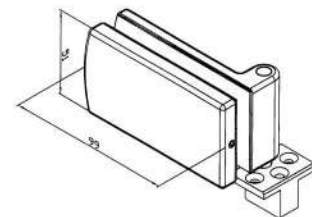

LAGOS STANDARD GLASS/WALL SLIDING DOOR ASSEMBLY

26601 (Kit)

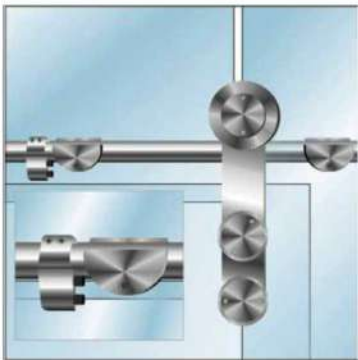

26601-1A (2Pcs)
SLIDING DOOR ROLLER

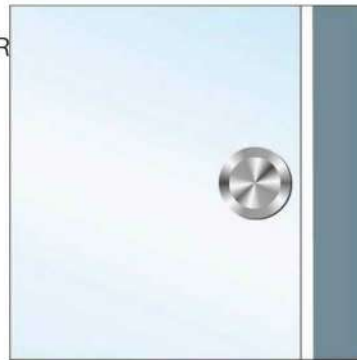

26601-004 (1Pc)
SLIDING HANDLE

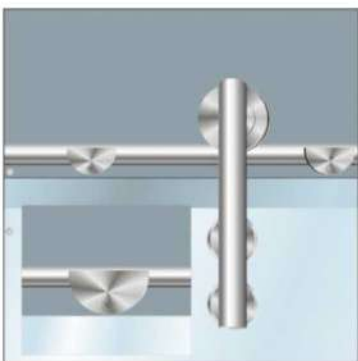

26601-2 (5Pcs)
CLAMP FIXING WALL

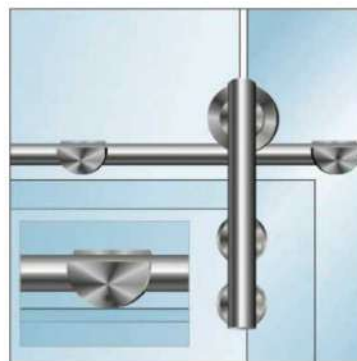

***26601-3**
CLAMP FIXING FOR
TRACK TO CONNECT
WITH GLASS

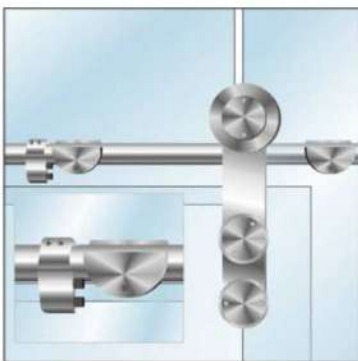

26601-5L (1Pc)
DOOR STOPPER

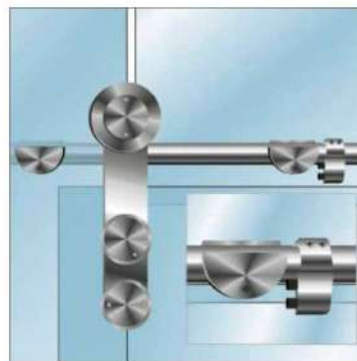

26601-5R (1Pc)
DOOR STOPPER

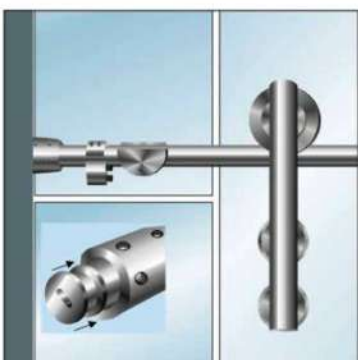

***26601-7F**
PIPE CONNECTOR

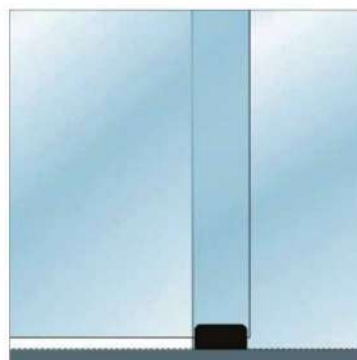

26601-6 (1Pc)
FLOOR GUIDE



Available Finishes



*Does not include in the kit

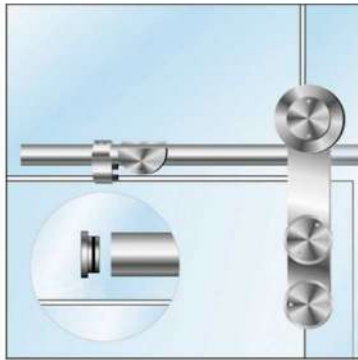

26601-005
(2Pcs)
END CAP

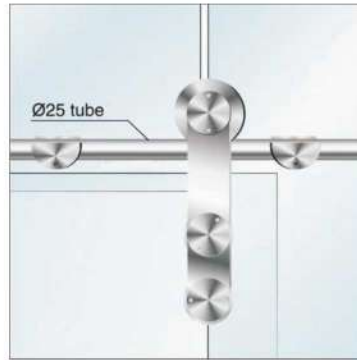

26601-25H
(1Pc)
ROD 103"



Dia (mm)	Thickness (mm)
25	2.0
25	2.5

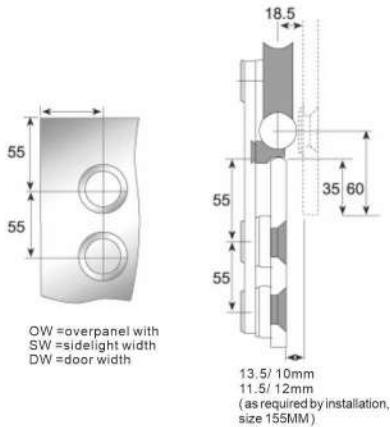

TECHNICAL DATA

Sidelight opening	Entry width	Door width	Tube length
910-1010mm	800-900mm	880-980mm	2038mm
1010-1110mm	900-1000mm	980-1080mm	2238mm
1110-1210mm	1000-1100mm	1080-1180mm	2438mm
1210-1310mm	1100-1200mm	1180-1280mm	2638mm

Note

The distance for clamp fixing for track, wall fixing:

1. Weight 80kgs: max-distance between the clamps= 1/2 the width of the door;
2. Weight 80kgs-120kgs: max-distance between the clamps= 1/3 the width of the door;
3. Weight 120kgs-150kgs: max-distance between the clamps= 1/4 the width of the door.

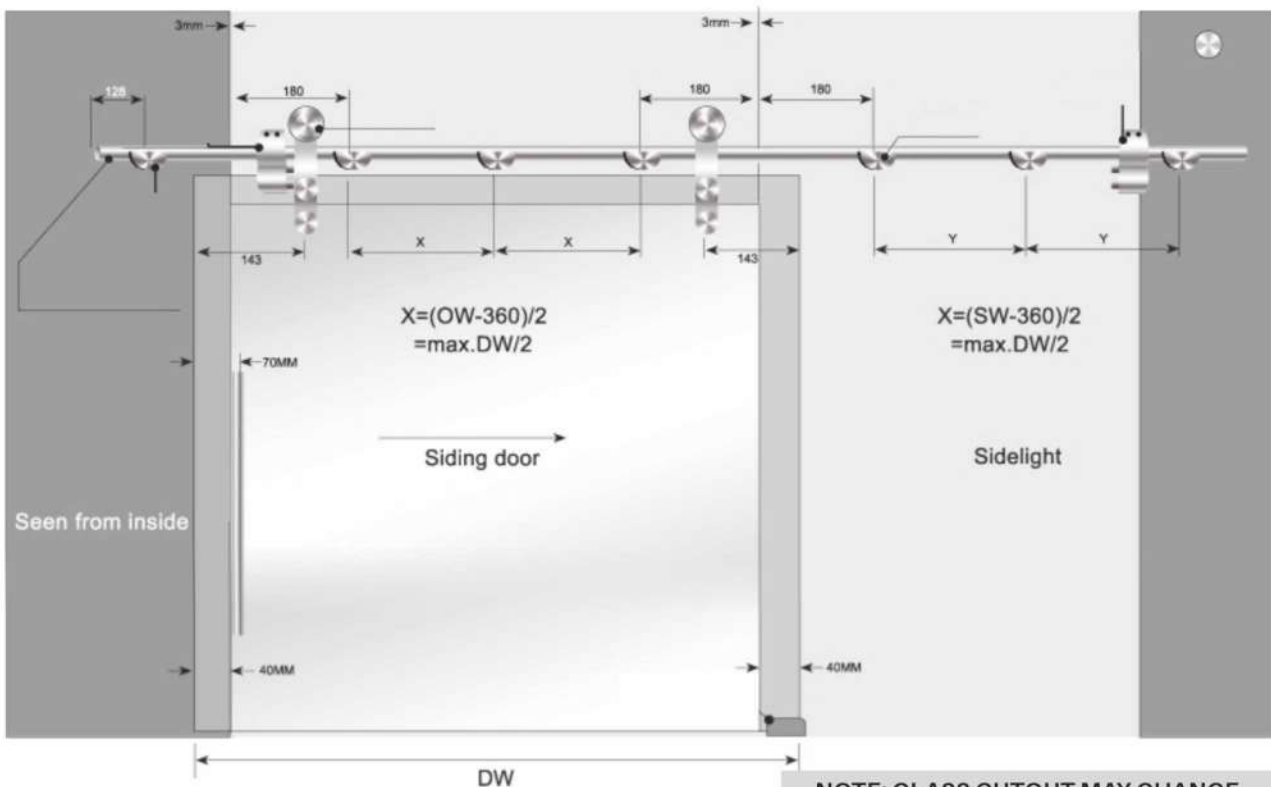

LAGOS SLIDING DOOR SYSTEMS

LAGOS BY PASS GLASS/WALL SLIDING DOOR ASSEMBLY

26602



26602-1D
SLIDING DOOR ROLLER



26602-004
SLIDING HANDLE

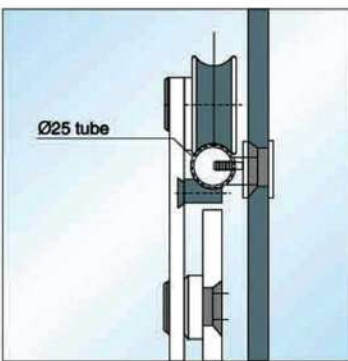

26602-044
CLAMP FIXING FOR WALL

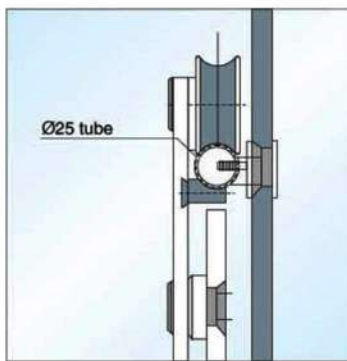
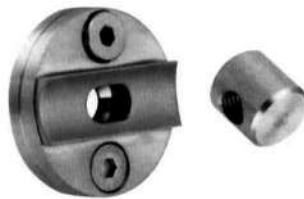

26602-003
CLAMP FIXING FOR TRACK AND GLASS

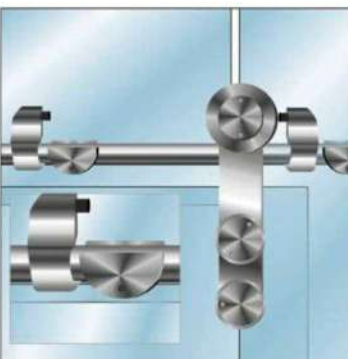

26602-023
DOOR STOPPER



26602-7F
PIPE CONNECTOR

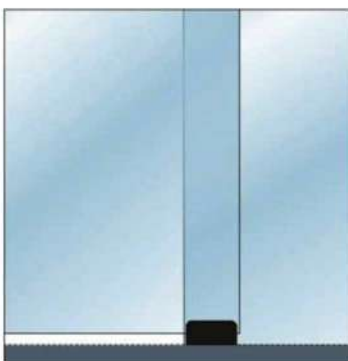

26602-6
FLOOR GUIDE

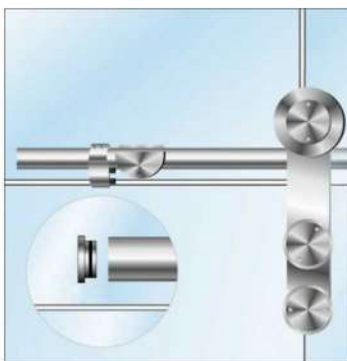

26602-022
END CAP



Available Finishes



CH BN MB MG



26602-1C
SLIDING DOOR
ROLLER



The glass maximum weight 150kg



26602-004
SLIDING
HANDLE

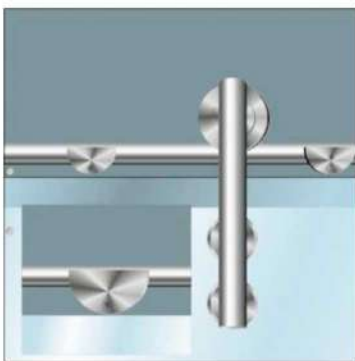

26602-2
CLAMP FIXING
FOR WALL

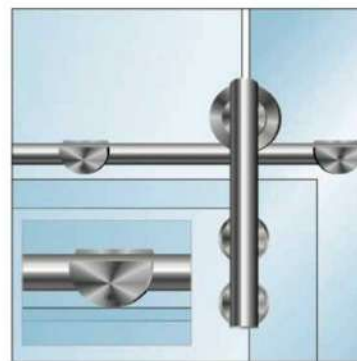

26602-3
CLAMP FIXING
FOR TRACK TO
CONNECT
WITH GLASS

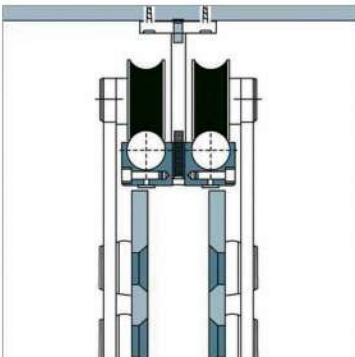

26602-020
DOUBLE TUBE TO
CEILING CLAMP

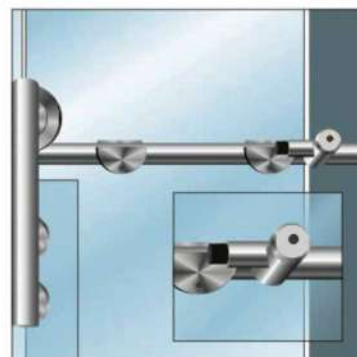

26602-11
DOOR STOPPER

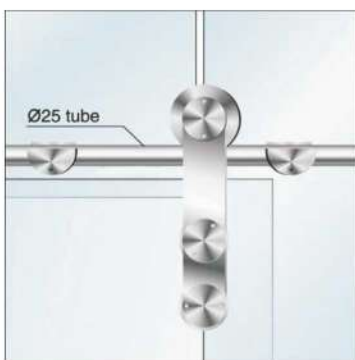

26602-25H
ROD



Dia (mm)	Thickness (mm)
25	2.0
25	2.5

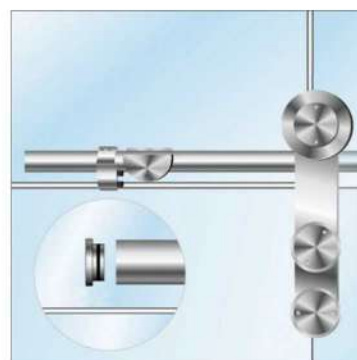

26602-022
END CAP



Available Finishes



26666



**EXCELLENT
CRAFTSMANSHIP**

LAGOS PREMIUM GLASS/WALL SLIDING DOOR ASSEMBLY

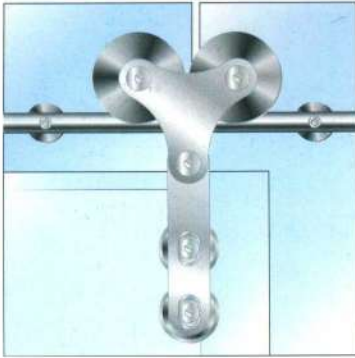

26666-001
SLIDING DOOR
ROLLER

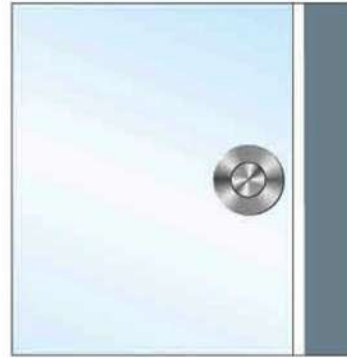

26601-004
SLIDING
HANDLE



26666-011
CLAMP FIXING
FOR WALL

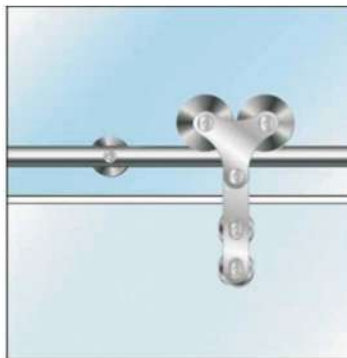

26666-002
CLAMP FIXING
FOR TRACK
TO CONNECT
WITH GLASS



26666-003
PIPE CONNECT



26666-004
DOOR STOPPER

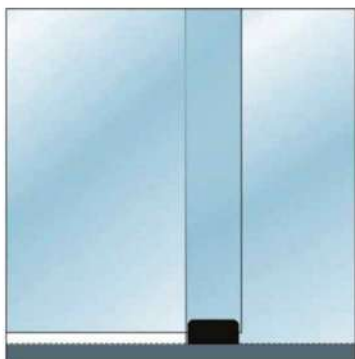

26666-6
FLOOR GUIDE

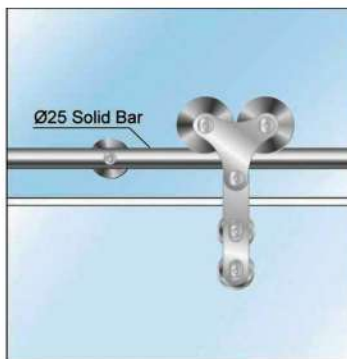

26666-25S
Ø25 SOLID BAR



Available Finishes



LAGOS SLIDING DOOR SYSTEMS

ANNECY WALL/CEILING MOUNTED DOOR ASSEMBLY

15026

ELEGANT
SLIDING
SYSTEM



ANNECY SLIDING DOOR SYSTEMS

15026-001 (2 Pcs.)

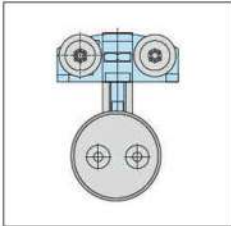

15026-002 (2 Pcs.)

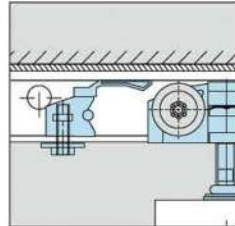

26601-004 (1 Pc.)
SLIDING HANDLE



15026-003 (2 Pcs.)

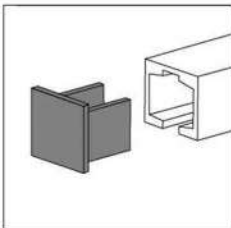

26601-006 (1 Pc.)

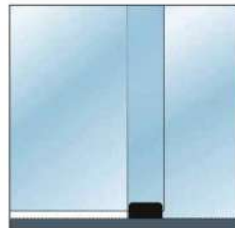

15026-T (1 Pc.)
OVERHEAD CHANNEL
120"

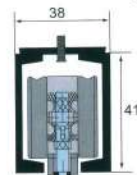
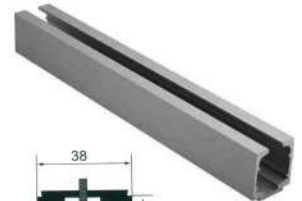

Glass Thickness : 8-10mm
Max Glass Width : 1000mm
Max Glass Door Weight : 80kg
Glass Fabrication Required : Holes required
in fixed panel and door

Available Finishes

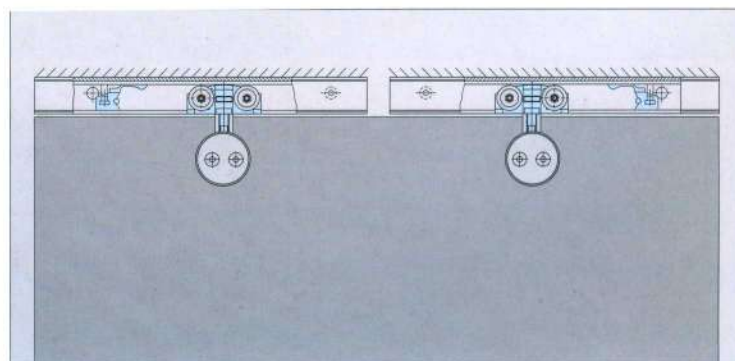

WALL/GLASS MOUNTED DOOR ASSEMBLY

15026-GC
GLASS TO TRACK CLAMP

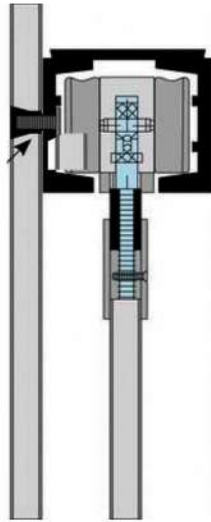

GLASS MOUNTED DOOR ASSEMBLY

15026-LC
WALL TO TRACK CLAMP

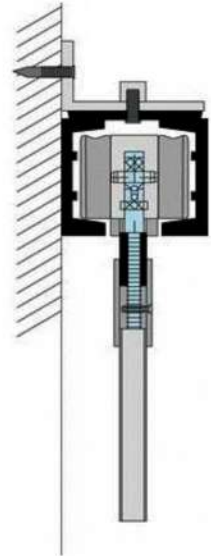

SIDE WALL MOUNTED DOOR ASSEMBLY

15026-11
FIXED CHANNEL



OVERHEAD TRACK WITH
1 MOVABLE PANEL &
1 FIXED PANEL

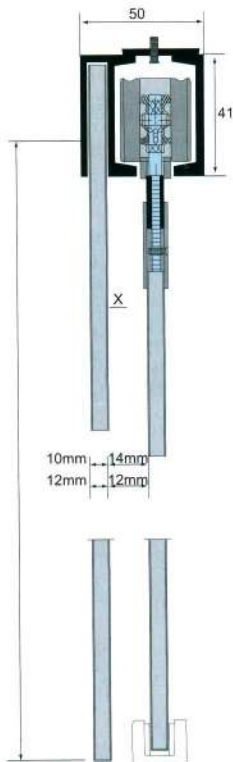

15026-22
PASS LINE



OVERHEAD BYPASS TRACK

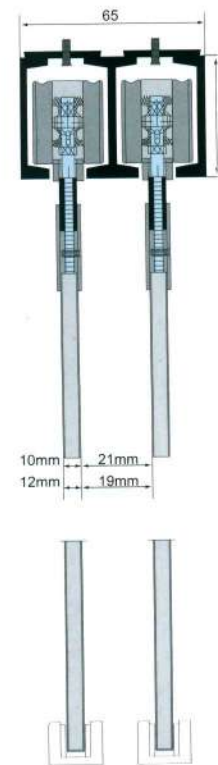

Available Finishes



CH BN MB

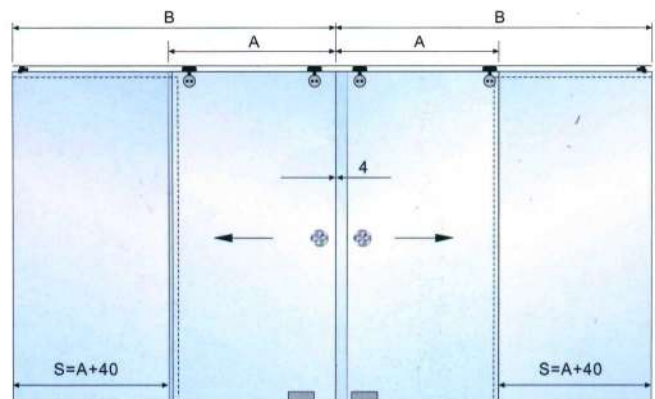
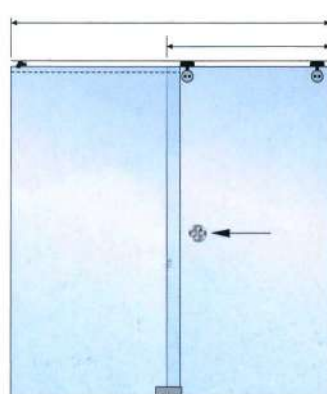

OPTIMA SOFT CLOSE SLIDERS FOR SINGLE DOORS

26066



**SOFT CLOSE
SLIDING SYSTEM**

Ceiling Mounted With Fixed Panel



Specifications-

For 8-12mm Glass Door
 Max Door Weight : 80Kg.
 Max Door Height : 2300mm
 Min Door Width : 750mm
 Track Bar Size : 57x59
 Material : Aluminum

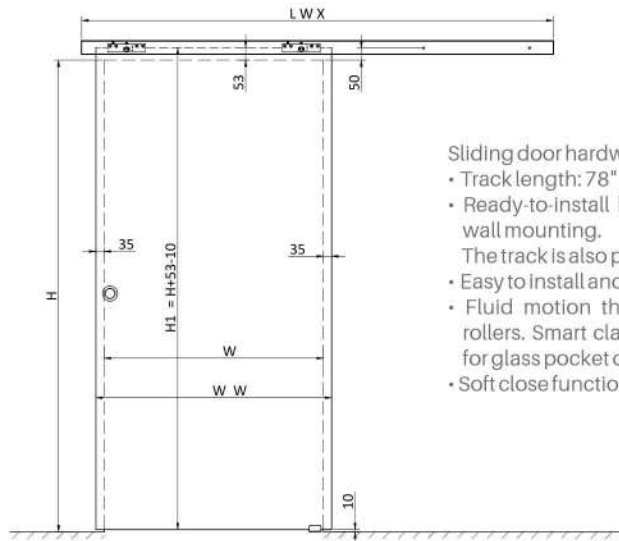

Sliding door hardware for OPTIMA Single glass door

- Track length: 78"
- Ready-to-install kit including sliding track and parts for wall mounting.
- The track is also pre-drilled for a ceiling mounting.
- Easy to install and long lasting.
- Fluid motion through smooth and silent ball bearing rollers. Smart clamp system avoids drilling glass. Perfect for glass pocket door too.
- Soft close function

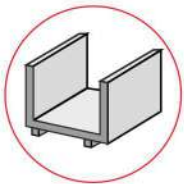







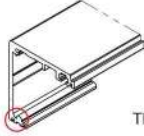

U CHANNEL FOR SIDE LIGHT
 SOLD SEPARATELY

Available Finishes

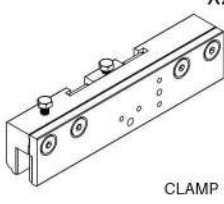
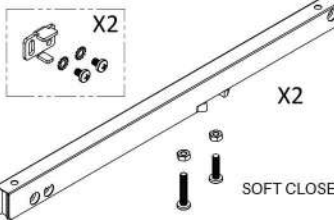

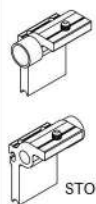
Parts list

 X1	 X1	 2-3Pcs Per 1m	 X2	 X1
 X2	 X2	 X1	 X1	 X1

AUSTIN SOFT CLOSE SLIDERS FOR DOUBLE DOORS

26067



SOFT CLOSE SYNCRO SLIDING SYSTEM

Options for :

- One moving & one fixed panel
- Both moving panels



Specifications-

- For 8-12mm Glass Door
- Max Door Weight : 80Kg.
- Max Door Height : 2300mm
- Min Door Width : 750mm
- Track Bar Size : 57x59
- Material : Aluminum

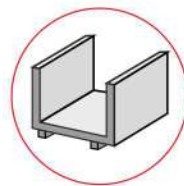

U CHANNEL FOR SIDELIGHT
SOLD SEPARATELY

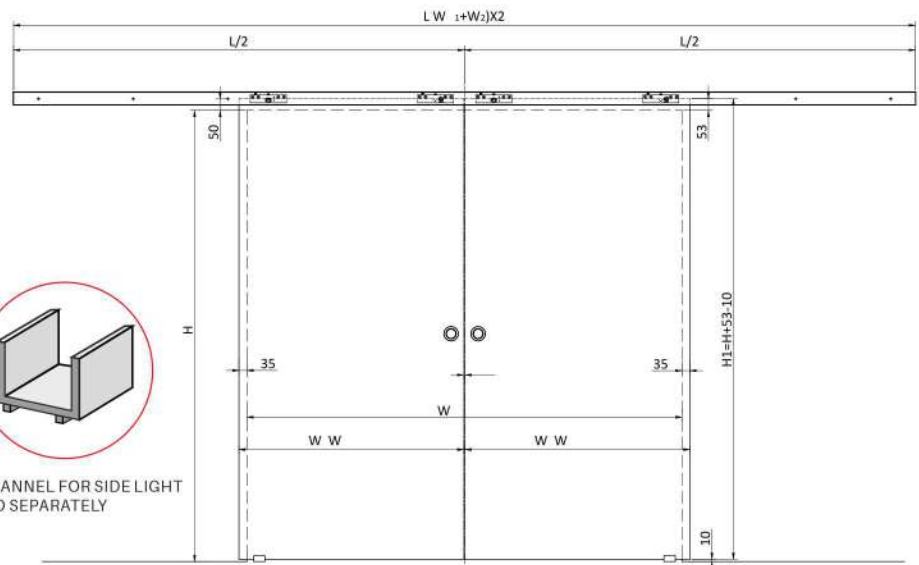

Sliding door hardware for AUSTIN
Single glass door

- Track length: 162"
- Ready-to-install kit including sliding track and parts for wall mounting.

The track is also pre-drilled for a ceiling mounting.
• Easy to install and long lasting.
• Fluid motion through smooth and silent ball bearing rollers.
Smart clamp system avoids drilling glass. Perfect for glass pocket door too.

Available Finishes



BN MB SA

Parts list

X1	X1	2-3Pcs Per 1m	X2	X2	X2	X1
TRACK	TRACK COVER	CLAMP	END CAP	SYNCRO	SYNCRO	SYNCRO
X4	X2	X2	X2	X2	X2	X2
CLAMP	SOFT CLOSER	SOFT CLOSER	GUIDE	GUIDE	STOPPERS	STOPPERS
					X1	X1
					TOOL	TOOL

TELESCOPIC SOFT CLOSE SLIDERS

26069



TELESCOPIC SLIDING DOOR SYSTEM

For Frame Glass Door and Wooden Door, Max Door Weight 100kg with Aluminium Track, Mounted On Wall, with Soft Close Function

TELESCOPIC SOFT CLOSE

OPTIONS :













- Double Panel System
- Triple Panel System
- Single Sliding
- Bi-parting

APPLICATIONS

- Hospitality
- Retail
- Healthcare
- Transportation
- Store Entrance
- Limited Space
- Room Divider

Available Finishes



	ITEM NO.	L2	L3
1 	26069B-01	2pcs	3pcs
2 	26069A-09	4pcs	6pcs
3 	26069B-05A	2(4)pcs	4(6)pcs
4 	26069-05A/100	(2)pcs	(2)pcs
5 	26069A-05	2pcs	2pcs
6 	26069A-06	1pcs	1pcs
7 	26069B-L-01	1pcs	2pcs
8 	26069B-L-02	1pcs	2pcs
9 	26069B-L-02-001	1pcs	1pcs
10 	26069B-L-05	1pcs	1pcs
11 	26069B-L-04	1pcs	3pcs
12 	26069B-L-06	1pcs	2pcs
13 	26069B-L-08	1pc	1pc

MANCHESTER COLLECTION

28088

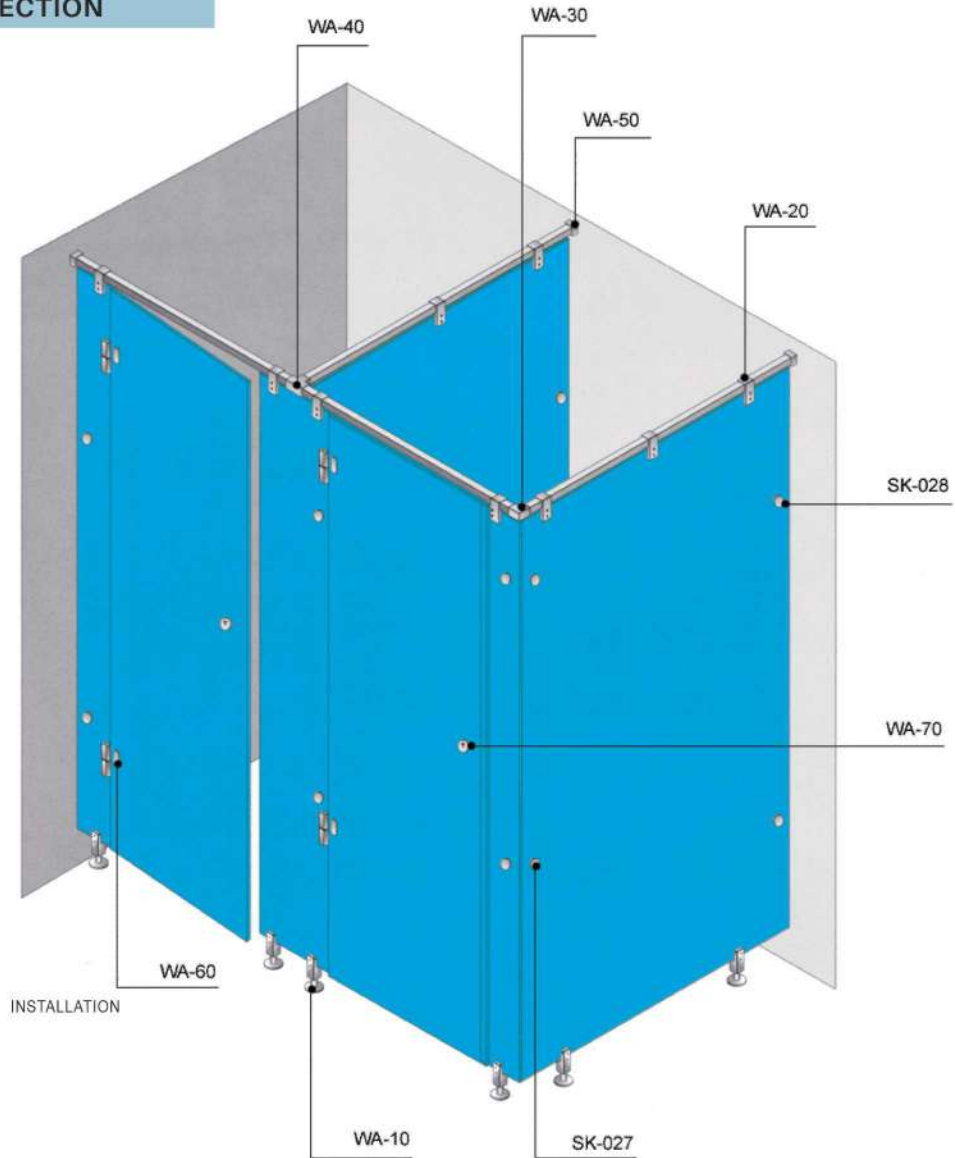

WA-10

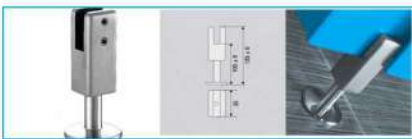

WA-20

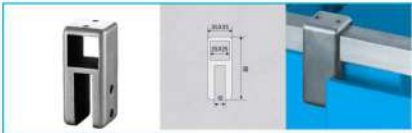

WA-30

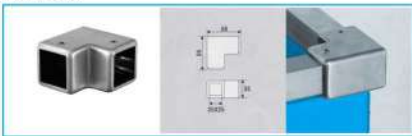

WA-40

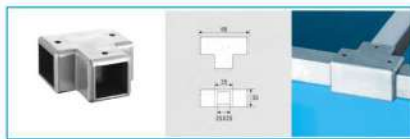

WA-50



WA-60

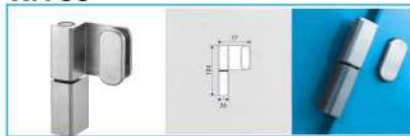

WA-70



SK-027



SK-028



SK-029



Available Finishes



BN

DOOR STOPPER SERIES

DOOR STOPPERS



35118
WALL MOUNT

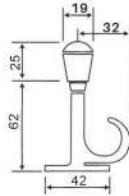

35117
WALL MOUNT

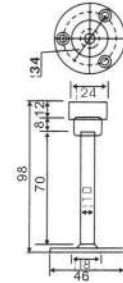

35151
FLOOR MOUNT

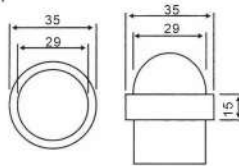

35112
WALL MOUNT

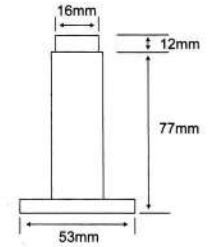

35154
FLOOR MOUNT

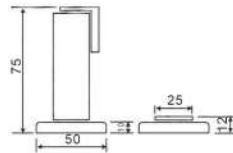

35111
FLOOR MOUNT

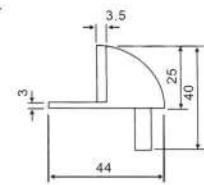

35120
FLOOR MOUNT

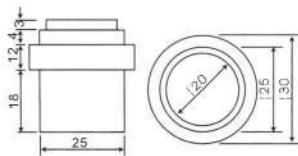

35137
FLOOR MOUNT

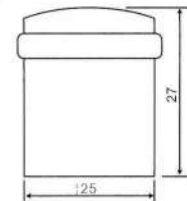

Available Finishes



BN

MB

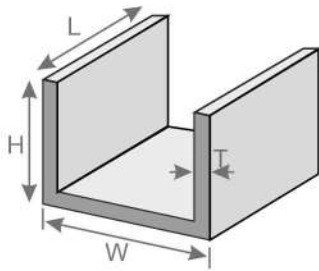

ALUMINUM U PROFILE CHANNELS

CODE	HEIGHT	WIDTH	LENGTH	THICKNESS	FINISH
15014SA-12	1.0"	1.0"	12'	1/8"	SATIN ANODIZED
15015SA-12	1.5"	1.0"	12'	1/8"	SATIN ANODIZED
15016SA-12	2.0"	1.0"	12'	1/8"	SATIN ANODIZED

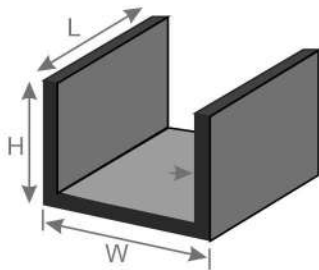

ALUMINUM U PROFILE CHANNELS

CODE	HEIGHT	WIDTH	LENGTH	THICKNESS	FINISH
15014MB-12	1.0"	1.0"	12'	1/8"	MATT BLACK
15015MB-12	1.5"	1.0"	12'	1/8"	MATT BLACK
15016MB-12	2.0"	1.0"	12'	1/8"	MATT BLACK
15014MB-16	1.0"	1.0"	16'	1/8"	MATT BLACK
15015MB-16	1.5"	1.0"	16'	1/8"	MATT BLACK
15016MB-16	2.0"	1.0"	16'	1/8"	MATT BLACK

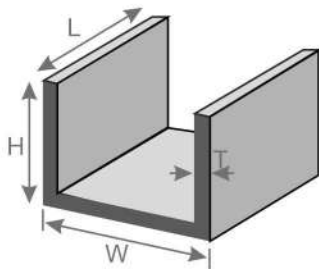

ALUMINUM U PROFILE CHANNELS

CODE	HEIGHT	WIDTH	LENGTH	THICKNESS	FINISH
15014BN-12	1.0"	1.0"	12'	1/8"	BRUSH NICKLE
15015BN-12	1.5"	1.0"	12'	1/8"	BRUSH NICKLE
15016BN-12	2.0"	1.0"	12'	1/8"	BRUSH NICKLE
15014BN-16	1.0"	1.0"	16'	1/8"	BRUSH NICKLE
15015BN-16	1.5"	1.0"	16'	1/8"	BRUSH NICKLE
15016BN-16	2.0"	1.0"	16'	1/8"	BRUSH NICKLE



ALUMINUM U PROFILE GASKETS

CODE	DETAILS
15017	Gasket for 12mm Glass
15018	Gasket for 10mm Glass

70 DUROMETER EXTRUDED EPDM

80013

GASKET SETTING TOOL



Available Finishes



ALUMINUM U PROFILE END CAPS

CODE	HEIGHT	WIDTH	THICKNESS	FINISH
15055	1.0"	1.0"	1/8"	BN/MB/SA
15056	1.5"	1.0"	1/8"	BN/MB/SA
15057	2.0"	1.0"	1/8"	BN/MB/SA

