



**SYLVI**  
RACE WITH TIME



# Analog + Digital

Watch Instruction Manual

---

(SYLVI HAWK)



[www.sylvi.in](http://www.sylvi.in)

# Index

No.	Subject	Page
1.	Brief Introduction	03
2.	Operation Guide	04
	•How to set Time	04
	•How to view Date	04
	•How to set Alarm	05
	•How to turn On/Off Alarm	05
	•How to set Stopwatch	05
	•How to use Lap Timing	05
3.	Battery Instructions	06
4.	Strap Instructions	06
5.	Water Resistant	07
6.	Warranty Instructions	08
7.	Claim Warranty	09
8.	Contact Us	09

# Brief Introduction

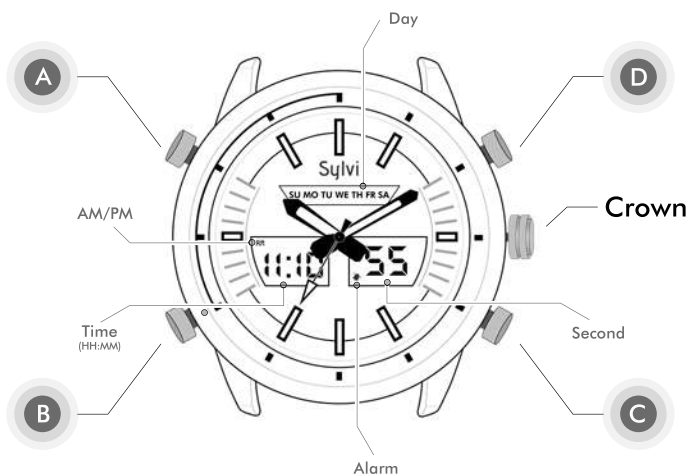

## • Watch Dial

- Diameter : 35mm

## • Watch Case

- Height : 54mm

- Diameter : 47mm

- Thickness : 15mm

## • Strap

- Width : 23mm

- Thickness: 4.12mm

**A** Light Button

**B** Mode Change

**C** Reset Button

**D** Start/Stop Button

**Water Resistant**

3 ATM

# Operation Instructions

## • How to Set Time:-

- Analog Watch

- Digital Watch

### Analog Watch

1. Pull out the crown to position B.
2. Turn crown either way to correct time.
3. Fix your correct time.
4. Push in the crown to the position A (Normal).



### Digital Watch

In normal mode, press B three times. You will enter into a setting mode where seconds will be flashing. Press D to zero.

Press C, the "Hours" will flash. Press D for adjusting "Hours"

Press C, the "Minutes" will flash. Press D to adjust "Minutes"

Press C, the "Month" will flash. Press D to adjust "Month"

Press C, the "Date" will flash. Press D to adjust "Date"

Press C, the "week" will flash. Press D to adjust "Day"

Press the B key to exit.



## • How to view Date

In normal mode, press and hold D.



## • How to Set Alarm:-

In normal mode, Press B twice to enter Alarm mode and "hours" will flash

Press D to adjust the hour for your alarm. Pay attention to am/pm, 12H display A/P means AM/PM, 24H display "H" means HOUR

Press C, minutes will flash. Press D to adjust minutes for your alarm

Press the B key to exit.

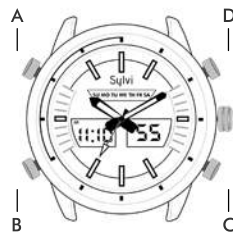

## • How to turn On/Off Alarm:-

In normal mode press C & D simultaneously.

If the Bell sign (🔔) on the display is visible,

Alarm is ON else OFF.

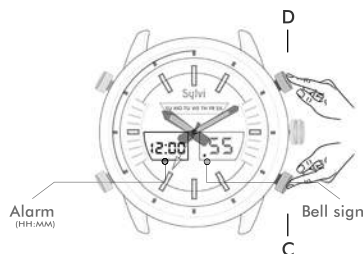

## • How to Set Stopwatch:-

In normal mode, Press B to enter Stopwatch mode

Press D to "Start/Stop".

## • How to use Lap Timing:-

*When stopwatch is set zero [00:00]:*

Press D to start stopwatch

Press C to pause stopwatch

Press C to resume stopwatch. *[Stopwatch will resume from Elapsed time]*

## • Battery Instructions



A CR2025 battery cell for Digital and LR626 for Analog display.

## • Strap Instructions

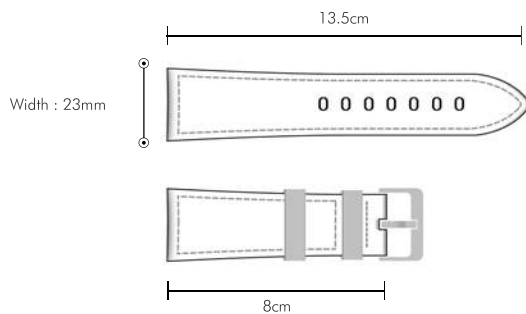

- The strap with 13.5cm at tail side and 8cm at buckle side.
- The strap with 23mm width.
- A replacement belt of lug size 24mm is suggested for this watch.





## • Water Resistant

**For information about the water-resistant rating of Sports, Casual, Chronograph, and Slim watches please refer to page 3.**

The water resistant rating provides guidelines for appropriate water-related exposure to avoid damage to internal watch components. Please see the chart for recommended usage guidelines.

**To ensure water does not enter the watch and cause damage to it, please follow the instructions listed below:**

- Do not adjust the crown while the timepiece is in contact with water.
- Ensure the crown is in the closed position before contact with water. For timepieces with screw-down crowns, ensure the crown is completely tightened before contact with water.
- For timepieces with pusher-enabled functionality, do not engage the function underwater.
- Exposure to the extreme atmosphere is not recommended (i.e. hot water, saunas, or steam rooms).
- Avoid exposure to water moving with force (i.e. water running from a faucet, ocean waves, or waterfalls).
- Avoid long exposure to saltwater. After contact with salt water, rinse the watch under tap water if rated 5ATM or higher and wipe dry with a soft cloth.

Recommendations For Water-Related Use				
Indication	 SPLASH RESISTANT (Hand Washing)	 SUBMERSIBLE (Swimming)	 SHALLOW DIVING (Snorkeling)	 SCUBA DIVING (Not Deep Sea)
None				
3 ATM • 30 Meters	✓			
5 ATM • 50 Meters	✓	✓		
10 ATM • 100 Meters	✓	✓	✓	
20 ATM • 200 Meters	✓	✓	✓	✓

## • Warranty Instructions

Your watch is warranted for six (6) months from the original date of purchase under the terms and conditions of the warranty. The warranty covers manufacturing defects, i.e. the watch movement, hands, and dial only. The covered components will be repaired or the watch will be replaced free of component and labor charges if it proves to be defective in material or workmanship under normal use.

- In case of replacement, we cannot guarantee that you will receive the same model watch. If your model is not available, a watch of equal value and similar style will be provided.

### **This warranty does not cover:**

- Any defect in materials and workmanship of battery, case, crystal, button, crown, strap, or bracelet; including plating on the case and/or bracelet.
- Damage resulting from improper handling, lack of care, accidents, normal wear and tear or aging.
- Water damage if care instructions for the product's water resistance levels (as per the product specification) were not followed.
- Products that are not purchased from an authorized retailer.
- This warranty is void if the watch has been damaged by accident, negligence of persons other than authorized sales or service agents, unauthorized service, or other factors not due to defects in materials and workmanship. This warranty is void if the serial number or product date codes or other tracking marks have been removed, altered, or obliterated.

## Get Additional Warranty



or

<https://sylvi.in/warranty-registration>

**Click Here to Open**



## • How to Claim Warranty?

### Step 1:

Contact customer care and report your problem. An RMA ID will be generated  
(Without RMA ID, warranty cannot be claimed)

### Step 2:

The product will have to be sent to service center including the following information.

**RMA ID** - Given by customer care executive

**Name**

**Full address**

**Daytime contact telephone number**

**Email address**

**Where your item was purchased from**

**Model reference of the item (Found on the back of your watch)**

**Full description of the work required**

**A copy of your proof of purchase**

## • How to reach us?

For any service-related inquiries and feedback, call our number  
**+919687660234** Monday to Saturday, 10.00 am to 7.00 pm.  
(closed on National and Festival holidays).

If you are unhappy for any reason, please mail us at [customercare@syivi.in](mailto:customercare@syivi.in).  
We promise to reply by the next working day.

