

LED SPOTLIGHT-CANLESS 3" SPECIALTY TRIMLESS FLOATING GIMBAL, FLAT

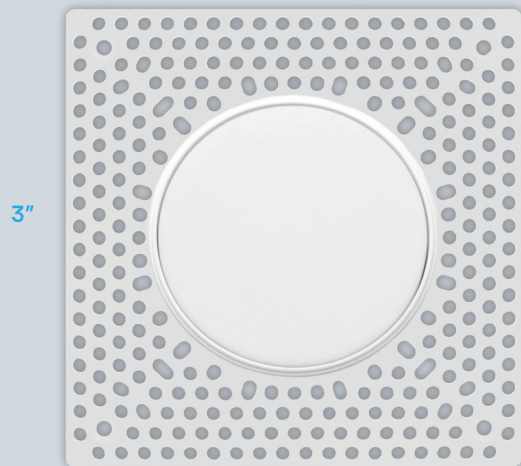

LR25452
FLOATING GIMBAL



LR25454
FLAT

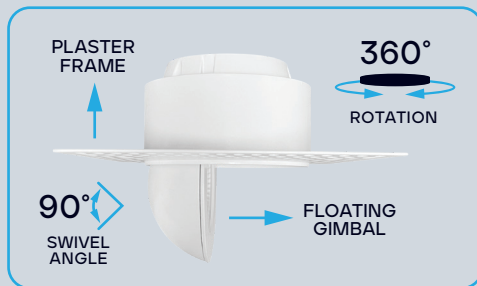

CRI 90

COLOR SELECTABLE

2700K 3000K 3500K 4000K 5000K

TRIMLESS



DIMMABLE

120V



5 YEAR WARRANTY

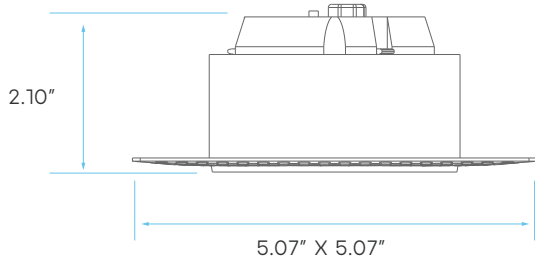

3" TRIMLESS - FLOATING GIMBAL
CUTOUT: Ø 3.38"

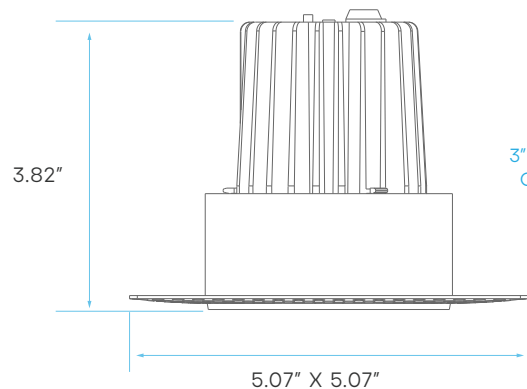

3" TRIMLESS - FLAT
CUTOUT: Ø 3.38"

ELECTRICAL

	MODEL	DESCRIPTION	POWER	INPUT VOLTS	EFFICACY	FLOOD	LIFETIME	COST/YR
GIMBAL	LR25452	LED/TLMD3/FGB/5CCT/RD/WT/D	12	120V	75	38°	50,000	\$ 1.44
FLAT	LR25454	LED/TLMD3/FLT/5CCT/RD/WT/D	15	120V	73	110°	50,000	\$ 1.80

PHOTOMETRIC

MODEL	DESCRIPTION	COLOR (CCT)	TEMP	LUMEN	CRI	ETL	PLATE (KNOCKOUT)
LR25452	LED/TLMD3/FGB/5CCT/RD/WT/D	2700K/3000K/3500K/4000K/5000K	CCT SELECT	900	90	YES	LR41004 (#2) LR41006 (#2)
LR25454	LED/TLMD3/FLT/5CCT/RD/WT/D	2700K/3000K/3500K/4000K/5000K	CCT SELECT	1100	90	YES	LR41010 (#R0)

COMPATIBLE WITH:

LR35126
Emergency LED Driver



LR41004
New Construction Mounting Plate

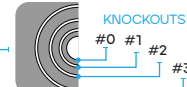

KNOCKOUT SIZE	
#0	Ø2.125" (Ø54 mm)
#1	Ø2.83" (Ø72 mm)
#2	Ø3.75" (Ø95 mm)
#3	Ø5.19" (Ø132 mm)

LR41006
New Construction Mounting Plate

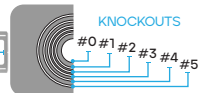
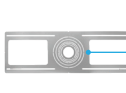

KNOCKOUT SIZE	
#0	Ø2.12" (Ø54 mm)
#1	Ø3.15" (Ø80 mm)
#2	Ø3.75" (Ø95 mm)
#3	Ø4.25" (Ø108 mm)
#4	Ø5.25" (Ø132 mm)
#5	Ø6.25" (Ø159 mm)

LR41010
New Construction Mounting Plate



KNOCKOUT SIZE	
#L0	Ø2.12" (Ø54 mm)
#L1	Ø2.83" (Ø72 mm)
#L2	Ø3.75" (Ø95mm)



KNOCKOUT SIZE	
#R0	Ø3.25" (Ø82 mm)
#R1	Ø4.33" (Ø110 mm)
#R2	Ø5.25" (Ø132mm)
#R3	Ø6.25" (Ø160 mm)