

## 48" LED SLIM LINEAR FIXTURE - CCT & WATTAGE SELECTABLE HIGH OUTPUT LR25225

READ THESE INSTRUCTIONS CAREFULLY BEFORE INSTALLATION. KEEP THESE INSTRUCTIONS FOR FUTURE REFERENCE. MAKE ELECTRICAL AND GROUNDED CONNECTIONS IN ACCORDANCE WITH THE NATIONAL ELECTRICAL CODE AND ANY APPLICABLE CODE. ALWAYS TURN OFF THE POWER SUPPLY BEFORE INSTALLATION. THIS PRODUCT MUST BE INSTALLED IN ACCORDANCE WITH THE APPLICABLE INSTALLATION CODE BY A QUALIFIED ELECTRICIAN WHO IS FAMILIAR WITH THE CONSTRUCTION AND OPERATION OF THE PRODUCT AND THE HAZARDS INVOLVED.

### WARNING

- RISK OF FIRE OR ELECTRIC SHOCK - Fixture installation requires knowledge of luminaires electrical systems. If not qualified, DO NOT attempt installation. Contact a qualified electrician.
- RISK OF FIRE OR ELECTRIC SHOCK - Suitable for wet locations. Always turn off the power supply before installation.
- RISK OF FIRE OR ELECTRIC SHOCK - Suitable for non-insulated surface and frame. DO NOT cover fixture with insulation liner or similar material.
- DO NOT install fixture on unstable, loose or easily breakable surface.
- DO NOT exert force on the surface of the fixture.

### CCT & WATTAGE SELECTABLE SWITCH

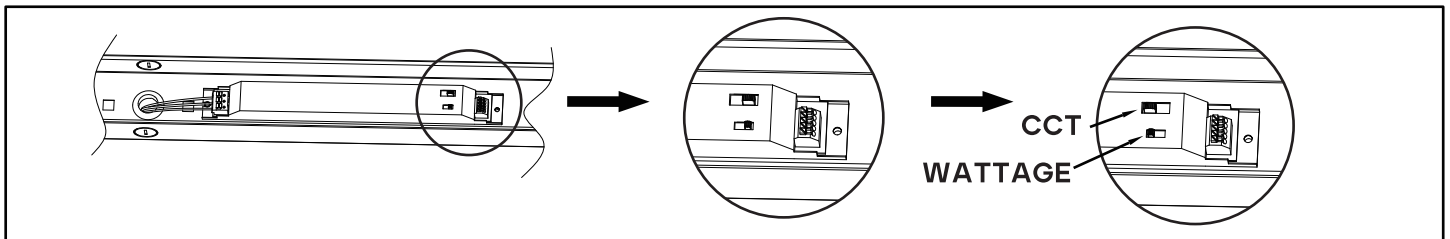

### SURFACE MOUNT INSTALLATION

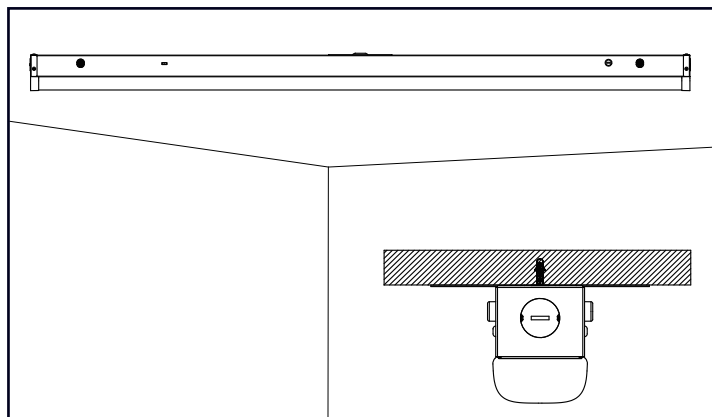

1. Punch a hole on the wall and put the expansion tube inside.

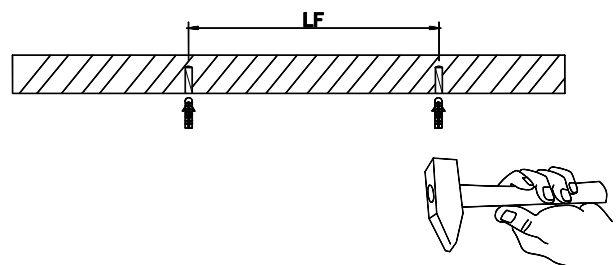

**THE INSTALLATION MUST BE CARRIED OUT BY A QUALIFIED ELECTRICIAN.**

2. Swing open fixture by pushing in/squeezing both buttons located on opposite ends.

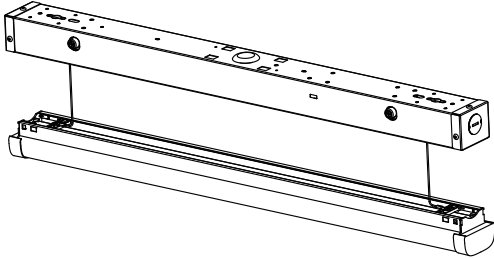

3. Run the fixture's power wires through the center hole of the round J-box adapter. Slide and secure the round J-box adapter on the center slots located on the back of the fixture. NOTE: J-box adapter is used to cover the junction box.

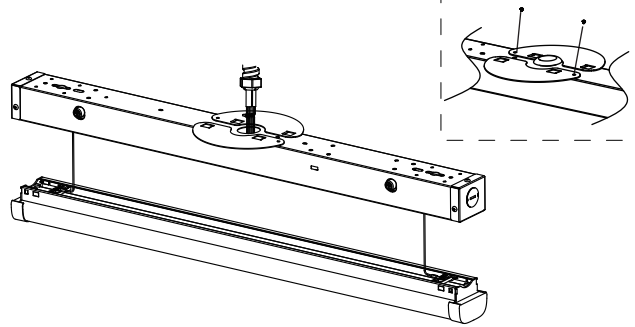

4. Turn off the power and make wiring by using wire nuts according to wiring diagram.

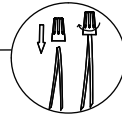
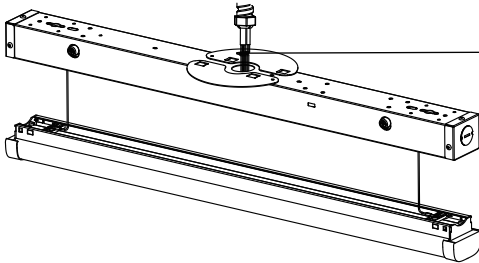

To source  
120-277V or  
120-347V

BLACK (LINE)  
WHITE (NEUTRAL)  
GREEN (GROUND)

FIXTURE

PURPLE (DIM+)  
PINK (DIM-)

5. Secure the fixture to the wall with the correct mounting hardware.

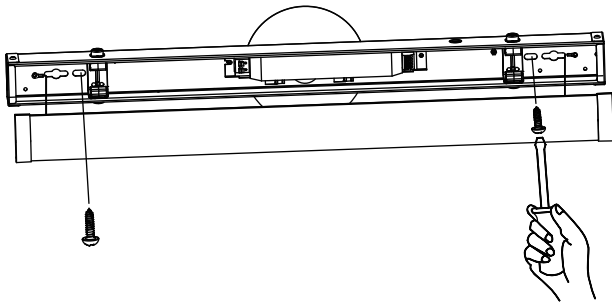

6. Press upward the cover and lock it tightly with the springs located on the fixture.

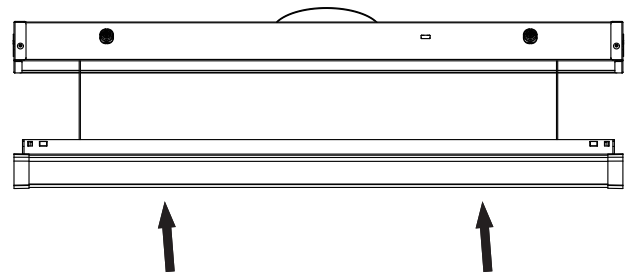

7. The installation is complete. Power the luminaire to verify operation.

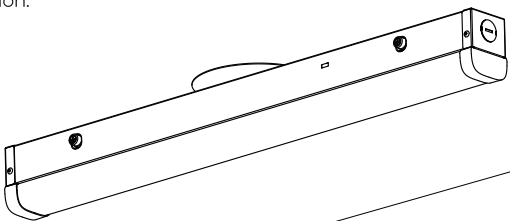

8. Swing open fixture by pushing in/squeezing both buttons located on opposite ends, if needed to disassemble fixture.

