

## 2', 3' - 3 CCT SELECTABLE LINEAR FIXTURE LR25191, LR25193

### WARNING

- To reduce the risk of death, personal injury or property damage from fire, electric shock, falling parts, cuts/abrasions, and other hazards read all warnings and instructions included with and on the fixture and all fixture labels.
- Before installing, servicing, or performing routine maintenance upon this equipment, follow these general precautions.
- Commercial installation, service and maintenance of luminaires should be performed by a qualified licensed electrician.
- For the installation: if you are unsure about the installation or maintenance of the luminaires, consult a qualified licensed electrician and check your local electrical code.
- To prevent wiring damage or abrasion, do not expose wiring to edges of sheet metal or other sharp objects.
- Do not make or alter any open holes in an enclosure of wiring or electrical components during kit installation.

### WARNING

- Turn off electrical power at fuse or circuit breaker box before wiring fixture to the power supply.
- Turn off the power when you perform any maintenance.
- Verify that supply voltage is correct by comparing it with the luminaire label information.
- All wiring connections should be capped with UL approved wire connectors.

### CAUTION

- Avoid direct eye exposure to the light source while it is on.
- Account for small parts and destroy packing material, as these may be hazardous to children.
- Risk of burn. Disconnect power and allow fixture to cool before changing bulb or handling fixture.

**NOTICE:** Green ground screw provided in proper location. Do not relocate.

**NOTICE:** Minimum 90° supply conductors.

**NOTICE:** Specifications and dimensions subject to change without notice.

**NOTICE:** Suitable for wet location.

### GENERAL WIRING DIAGRAM

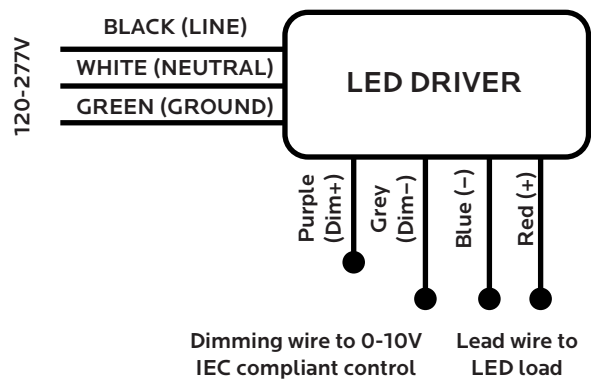

### A. CHAIN SUSPENDED MOUNTING

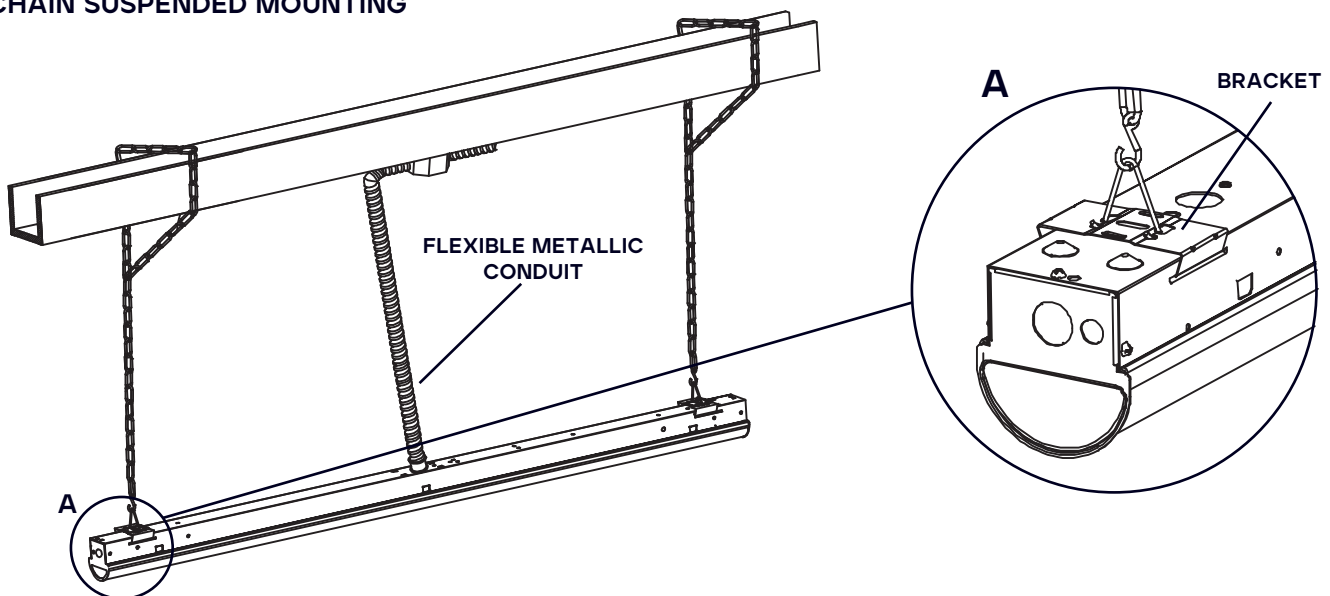

## B. SURFACE MOUNTING

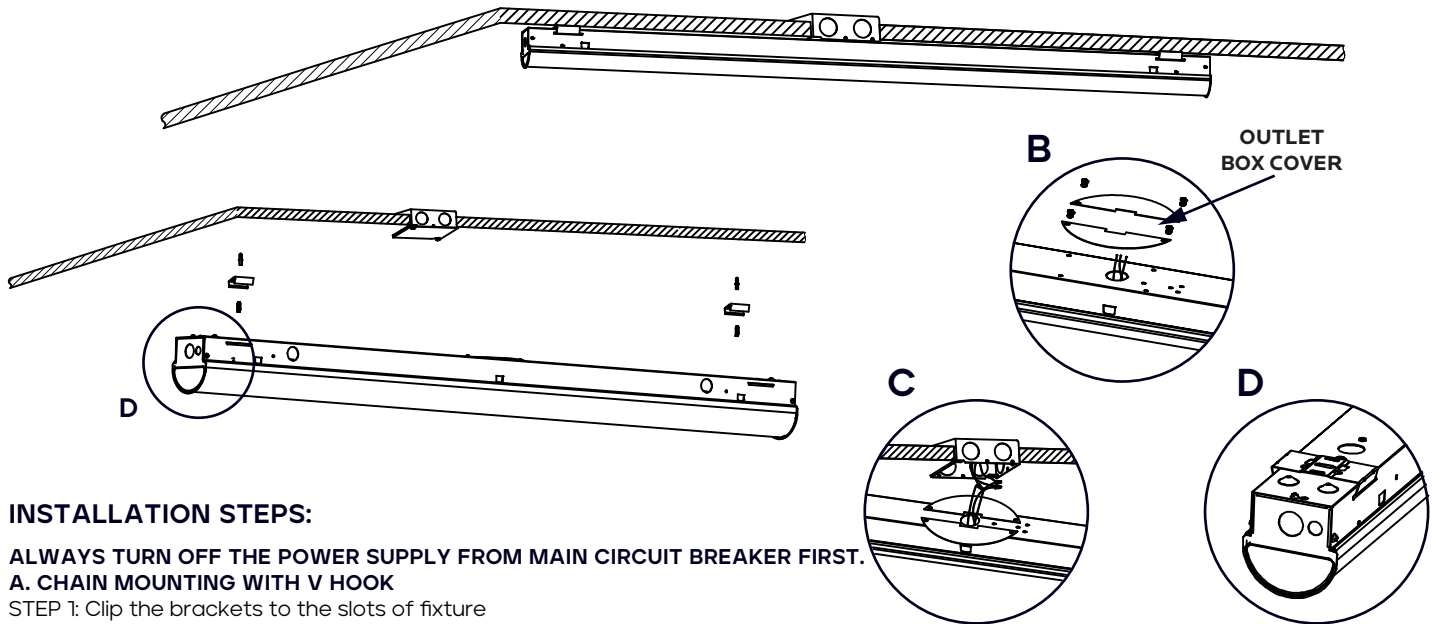

### INSTALLATION STEPS:

**ALWAYS TURN OFF THE POWER SUPPLY FROM MAIN CIRCUIT BREAKER FIRST.**

#### A. CHAIN MOUNTING WITH V HOOK

- STEP 1: Clip the brackets to the slots of fixture
- STEP 2: Attach customer supplied V-hooks to brackets
- STEP 3: Attach customer supplied chain to the V-hooks and mounting surface.

#### B. SURFACE MOUNTING

- STEP 1: Secure the provided brackets onto the ceiling by using the provided accessories and screws.
- STEP 2: Screw the covers at the outlet of the back of the housing. (FIGURE B)
- STEP 3: Wire to main power through the junction box (FIGURE C)
- STEP 4: Clip the brackets to the slots of the fixture (FIGURE D)

### FIELD-ADJUSTABLE CCT

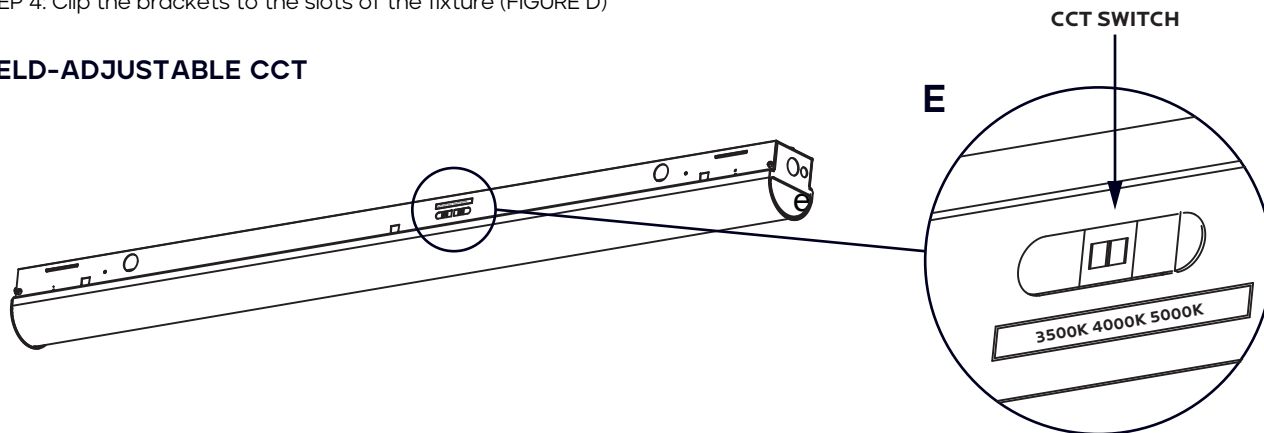

User may adjust the color temperature by using the DIP switch button integrated into the driver. The DIP switch is accommodated with 3 options (left, middle and right), corresponding to 3 color temperatures.

1. DIP switch is located onto the LED Module holder plate (FIG. E)
2. Select color temperature by sliding switch left or right respectively to the desired value. (FIG. E)