

1X4, 2X2, 2X4 LED BACKLIT PANEL - 5 CCT & WATTAGE SELECTABLE LR24290, LR24293, LR24295

PLEASE READ THESE INSTRUCTIONS CAREFULLY BEFORE INSTALLATION AND KEEP FOR REFERENCE. ELECTRICAL PRODUCTS CAN CAUSE DEATH OR INJURY, OR DAMAGE TO PROPERTY. IF IN ANY DOUBT ABOUT THE INSTALLATION OR USE OF THIS PRODUCT, CONSULT A COMPETENT ELECTRICIAN

RECESSED INSTALLATION

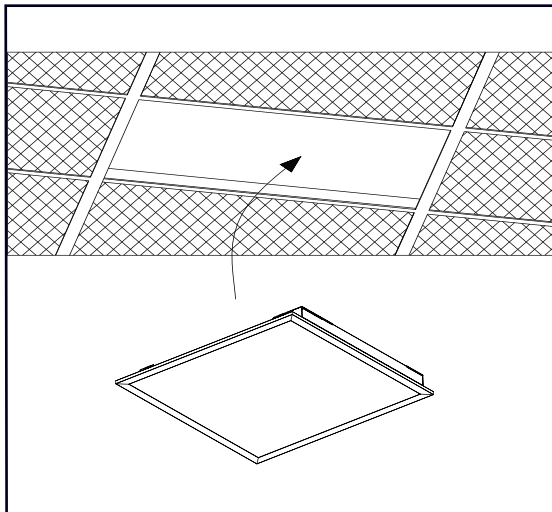

1. Replace existing lighting fixture from ceiling with LED panel

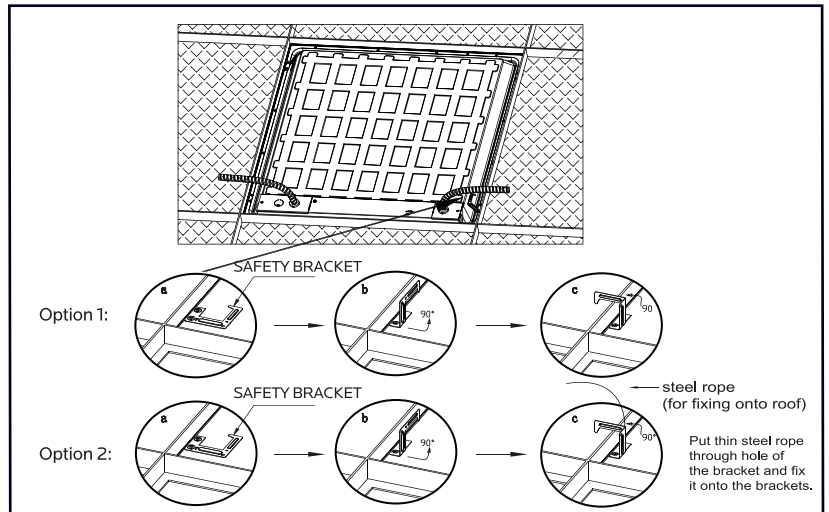

2. Use the safety brackets to secure and keep in place.

INSTALLATION GUIDE

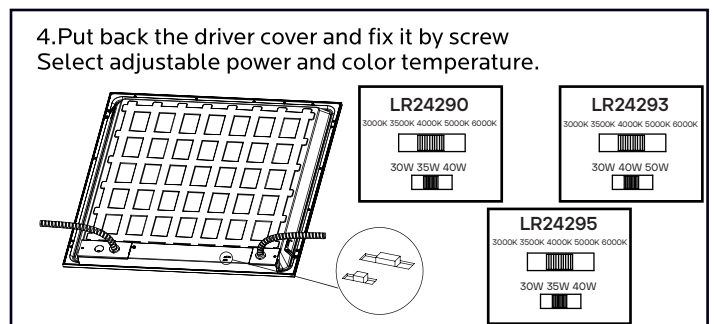
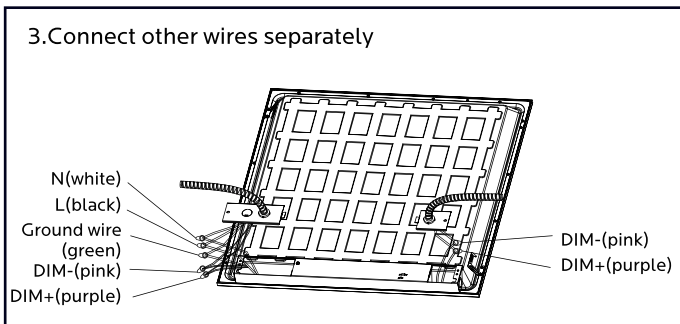
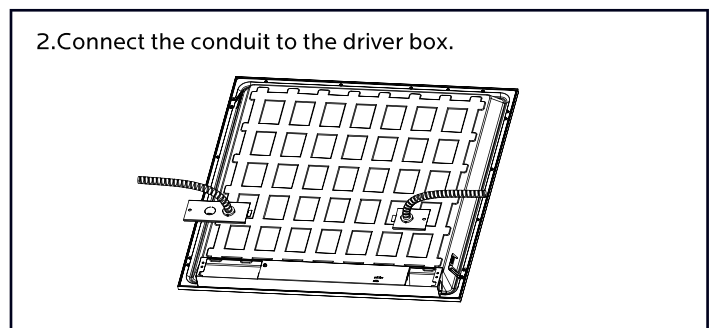
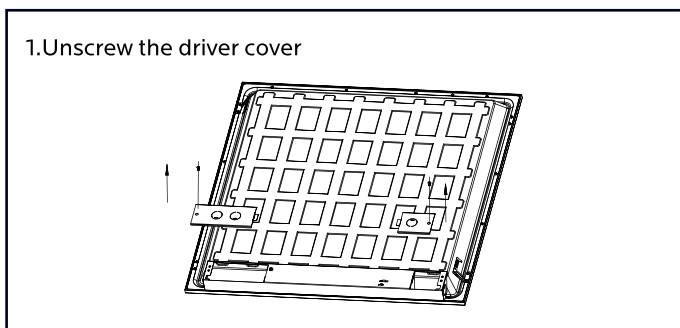

***OPTIONAL ACCESSORIES**

If there are more wires, you can choose to use enlarged j-box.

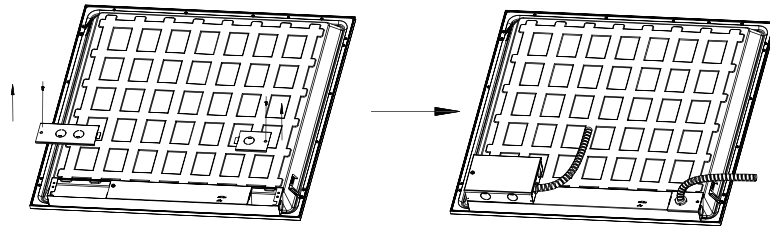

SUSPENSION KIT INSTALLATION

1. Drill two holes in the ceiling, and put the anchors into hole, then insert the wire rope and screw.

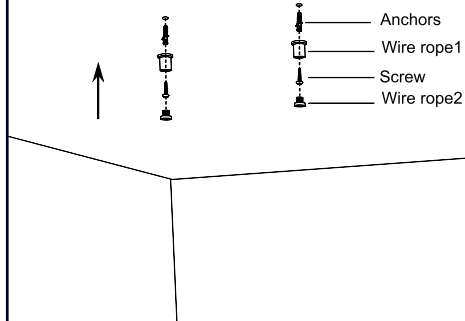

2. Adjusting the hanging rope making the panel in a horizontal state.

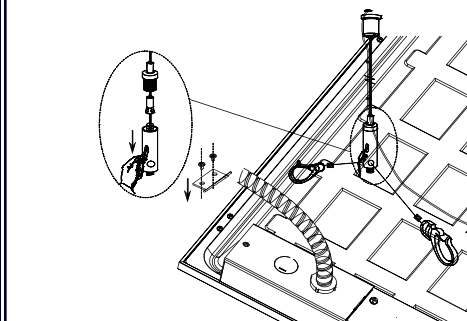

3. The installation is finished.

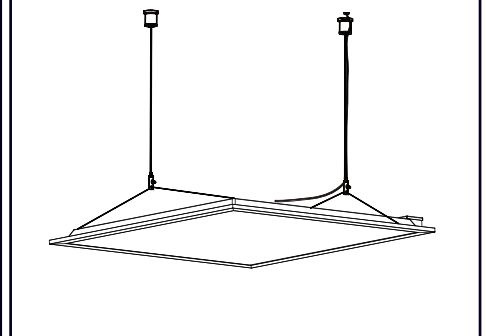

Note: 2*2/1*4/2*4ft: 2 pcs suspension kits needed for installation.

WIRING

