

## LED LAY IN FRAME PANEL - CCT & WATTAGE SELECTABLE 1X4', 2X2', 2X4'

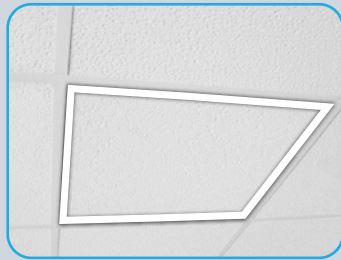

FRAME PANEL IN USE

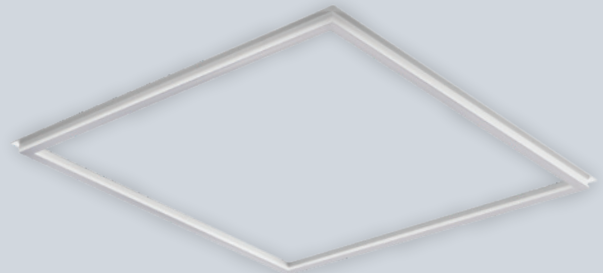

2X2'

20W | 30W | 40W

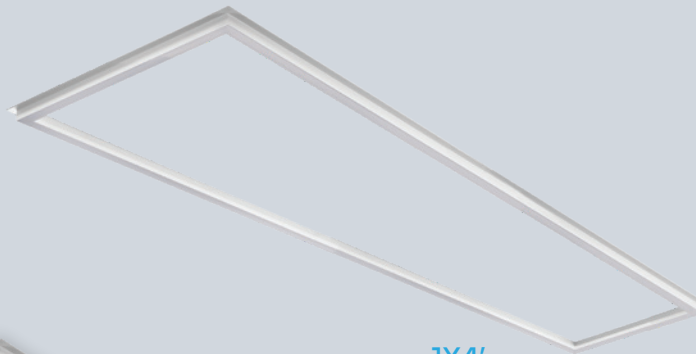

1X4'

20W | 30W | 40W

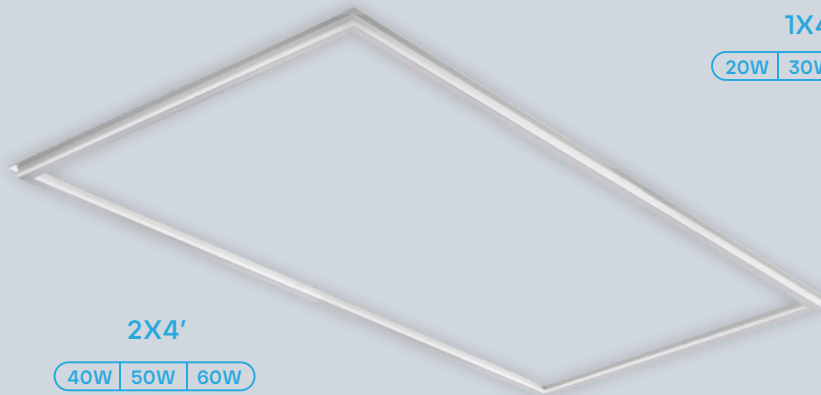

2X4'

40W | 50W | 60W

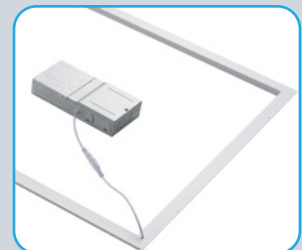

DRIVER WITH CCT & WATTAGE SELECT SWITCH



COLOR SELECTABLE

3000K | 3500K | 4000K | 5000K | 6500K

WATTAGE  
SELECTABLE

3 OPTIONS

DIMMABLE

0-10V



## ELECTRICAL

MODEL	DESCRIPTION	POWER	INPUT VOLTS	EFFICACY	LIFETIME	COST/YR	
1x4'	LR24168	LED1X4FRAME/PNL/3WO/5CCT/D	20	100-277V	130	50,000	\$ 4.81
			30				
			40				
2x2'	LR24164	LED2X2FRAME/PNL/3WO/5CCT/D	20	100-277V	130	50,000	\$ 4.81
			30				
			40				
2x4'	LR24166	LED2X4FRAME/PNL/3WO/5CCT/D	40	100-277V	130	50,000	\$ 7.22
			50				
			60				

## PHOTOMETRIC

MODEL	DESCRIPTION	COLOR (CCT)	TEMP	LUMEN	FLOOD	CRI	ETL	PREMIUM
LR24168	LED1X4FRAME/PNL/3WO/5CCT/D	3000K/3500K/4000K/5000K/6500K	CCT SELECT	2600 (@20W)	120°	80	YES	
				3900 (@30W)				
				5200 (@40W)				
LR24164	LED2X2FRAME/PNL/3WO/5CCT/D	3000K/3500K/4000K/5000K/6500K	CCT SELECT	2600 (@20W)	120°	80	YES	YES
				3900 (@30W)				
				5200 (@40W)				
LR24166	LED2X4FRAME/PNL/3WO/5CCT/D	3000K/3500K/4000K/5000K/6500K	CCT SELECT	5200 (@40W)	120°	80	YES	YES
				6500 (@50W)				
				7800 (@60W)				

COMPATIBLE WITH:

**LR35124**  
Emergency LED Driver



**LR24183**  
4' CABLE EXTENDER



## DIMENSIONS

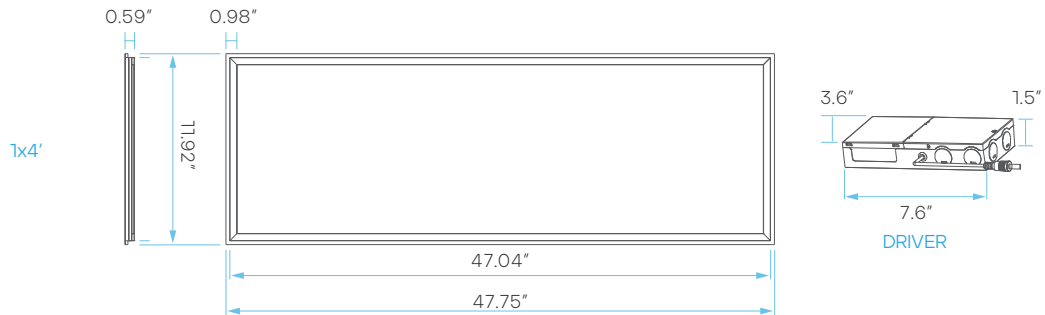

## DIMENSIONS

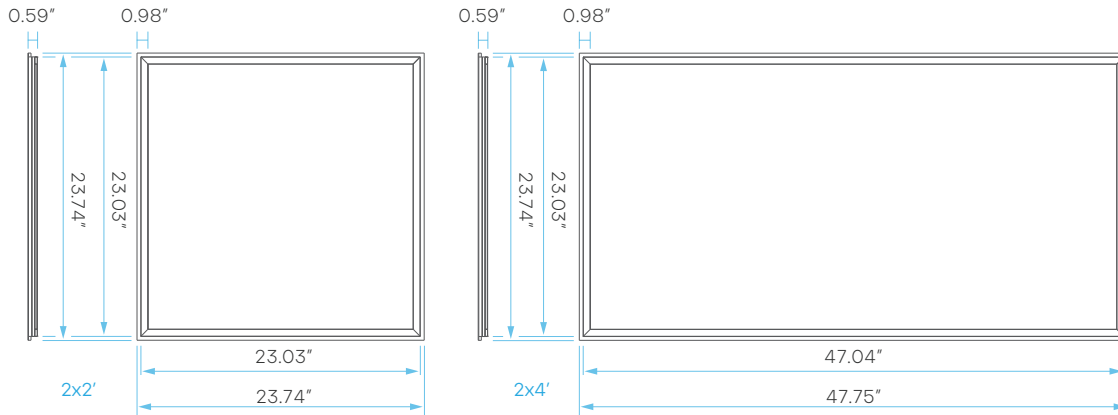

## 2X2 FRAME PANEL CANOPY

COMPATIBLE WITH LR24185

\*SOLD SEPARATELY

MODEL	DESCRIPTION
LR24184	LED2X2FRAME/PNL/CANOPY

