

4" DOWNLIGHT RETROFIT SQUARE TRIM - 5 CCT SELECTABLE LR23786, LR23787

WARNING: For safety, read and understand instructions completely before starting installation. Electricity should be turned off at the fuse or the circuit breaker box before installing the fixture. All electrical connections must be in accordance with N.E.C or your local code.

CAUTION: DISCONNECT POWER BEFORE CONNECTING TRIM TO HOUSING. FAIL TO DO SO MAY PERMANENTLY DAMAGE THE LED

PACKAGE CONTENTS

DOWNLIGHT

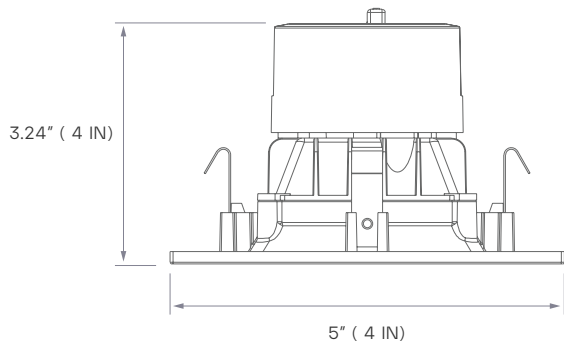

E26 BASE ADAPTER



4" RECESSED HOUSING

1. Turn off the main power prior to installation
2. Remove the existing trim and bulb to gain access to the socket.
3. Screw in the E26 socket adaptor into the open socket. (FIGURE 1)
4. Plug in the quick connector. (FIGURE 2)
5. Once connector is attached, gently push trim into fixture opening until flush with ceiling. (FIGURE 3)
6. (For 4" Downlights) Unscrew and adjust the plate inward or outward for 4" diameter

FIGURE 1

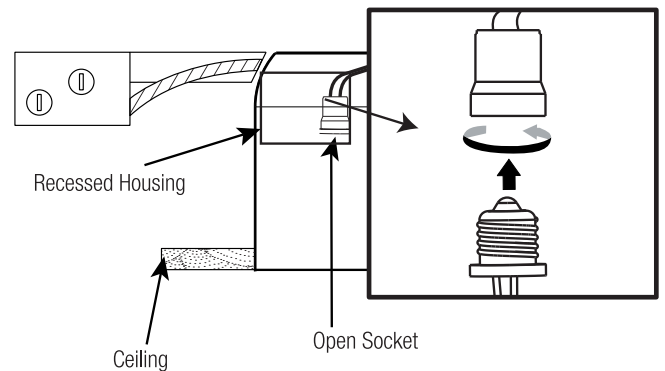

FIGURE 2

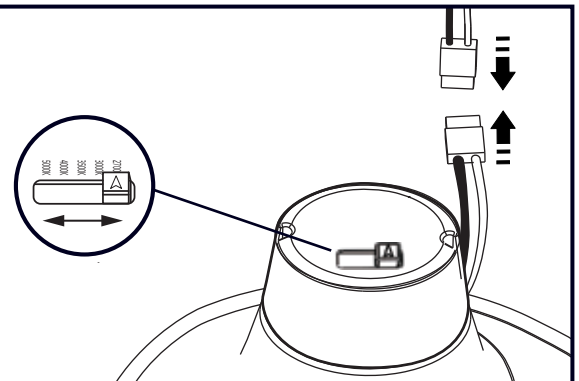

FIGURE 3

