

## 4" & 6" FIRE RATED RECESSED MINI FLAT PANEL BAFFLED TRIM - CCT SELECTABLE LR23491, LR23493

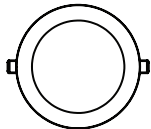

**BOX INCLUDES:**



FIXTURE (1)

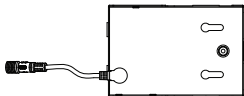

DRIVER BOX (1)



TEMPLATE (1)

**TOOLS NEEDED: SCREW DRIVER AND A PAIR OF WIRECUTTERS.**

**IMPORTANT**  
READ CAREFULLY BEFORE INSTALLING FIXTURE. KEEP THESE INSTRUCTIONS FOR FUTURE REFERENCE.

This fixture must be wired in accordance with the National Electrical Code and all applicable local codes. Proper grounding is required for safety. THIS PRODUCT MUST BE INSTALLED IN ACCORDANCE WITH THE APPLICABLE INSTALLATION CODE BY A PERSON FAMILIAR WITH THE CONSTRUCTION AND OPERATION OF THE PRODUCT AND THE HAZARDS INVOLVED. TO PREVENT ELECTRICAL SHOCK, POWER SHOULD BE TURNED OFF AT THE FUSE BOX BEFORE INSTALLATION.

**SAFETY WARNINGS - READ ALL PRODUCT LABELS AND DIRECTIONS**

- **WARNING - RISK OF FIRE OR ELECTRIC SHOCK.** Install this kit only in the luminaires that have the construction features and dimensions shown in the photographs and/or drawings and where the input rating of the retrofit kit does not exceed the input rating of the retrofit kit does not exceed the input rating of the luminaire.
- Installation should be performed only by a qualified electrician in accordance with the National Electrical Code and relevant local codes. DO NOT make or alter any open holes in an enclosure of wiring or electrical components during kit installation.
- **WARNING** - To prevent wiring damage or abrasion, do not expose wiring to edges of sheet metal or other sharp objects.
- **INSTALLATION SHOULD ONLY BE PERFORMED AFTER POWER TO THE FIXTURE HAS BEEN DISCONNECTED.**
- This device complies with Part 15 of the FCC Rules. Operation is subject to the following two conditions: (1) this device may not cause harmful interference, and (2) this device must accept any interference received, including interference that may cause undesired operation.

**INSTALLATION INSTRUCTIONS:**

1. TURN POWER OFF FROM THE ELECTRICAL PANEL BEFORE INSTALLATION.
2. Use template inside box to cut hole in ceiling (FIG. 1)

FIG. 1

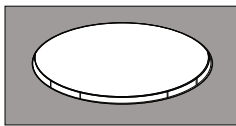

3. Open the driver box and remove the knockouts. (FIG. 2)

FIG. 2

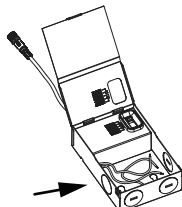

4. Insert the electrical supply cable through the knockout and secure with a cable connector. Wire driver box (FIG. 3), white-white, black-black, green-green/ ground. Place all wiring and connections back into the box, close the cover and select desired CCT (FIG. 4)

FIG. 3

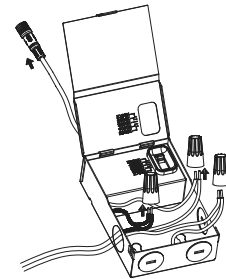
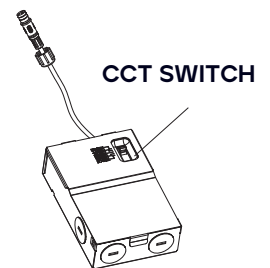
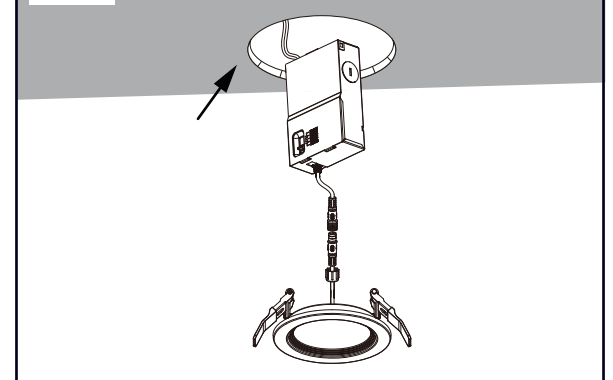

FIG. 4



5. Place the driver box into the ceiling and connect the fixture to driver box. (FIG. 5)

FIG. 5



6. Lifting both retention tabs upward. Push until trim sits flush against ceiling. (FIG. 6)

FIG. 6

