

## 4" REGRESSED STEP BAFFLED TRIM - 5CCT SELECTABLE LR23267

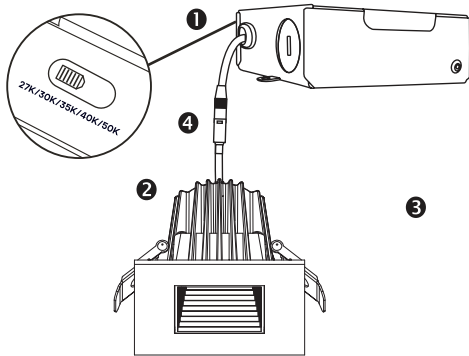

### PARTS

- ❶ JUNCTION BOX
- ❷ ANTI-GLARE DOWNLIGHT
- ❸ SPRING CLIPS
- ❹ CONNECTOR

### ⚠ WARNING

TURN THE POWER OFF FROM ELECTRICAL PANEL BEFORE INSTALLATION OR MAINTENANCE.

### FIXTURE INSTALLATION:

1. Turn power OFF from the electrical panel prior to installation.
2. Determine the location for installation and cut the ceiling hole in accordance with cut-hole dimensions. Refer to CUTOUT size. (Fig. 1)
3. Open the junction box cover and remove the appropriate knockout(s) on the side panel (Fig. 2)
4. Insert the electrical supply cable through the knockout and secure with a cable connector (sold separately).
5. Using quick-connect push-in terminals, connect the ground wire to the green wire terminal; black wire to black wire terminal; white wire to white wire terminal. (Fig. 2)
6. Place all wiring and connections back into the box and close the cover. Connect the driver to the light panel.
7. Insert Junction box through the mounting hole. (Fig. 3)
8. Push spring-loaded clips on the fixture upwards and insert fixture base into the mounting hole. Release the clips and fixture will be pulled flush to the ceiling. (Fig. 4)

- DO NOT MODIFY THIS FIXTURE. ANY MODIFICATIONS MAY RENDER THE PRODUCT UNSAFE AND VOID WARRANTY.
- THIS PRODUCT IS SUITABLE FOR DAMP LOCATIONS

### LIMITED WARRANTY

The warranty applies to the product from the original date of purchase for five (3) years against manufacturing defects. The owner must provide a copy of the original proof of purchase. The manufacturer's obligation under this warranty is limited to repairing or replacing the component. It is not related in any way to the cost of the connection, the installation of the replacement parts or cost of transport.

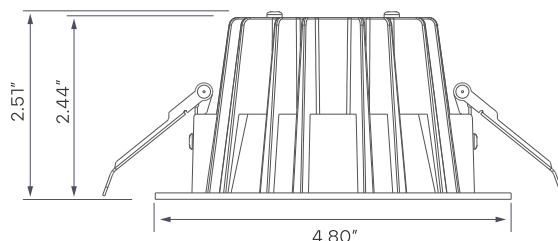
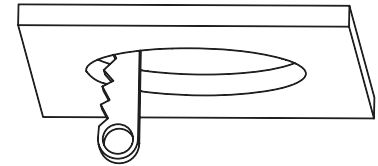
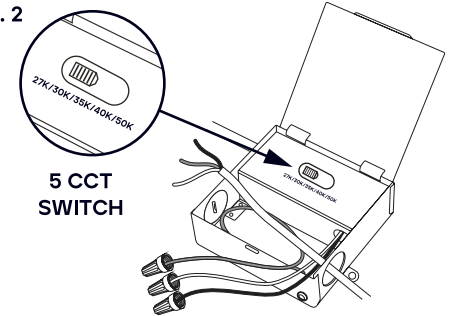

FIG. 1



4" CUTOUT DIAMETER: 4.25"

FIG. 2



5 CCT SWITCH

FIG. 3

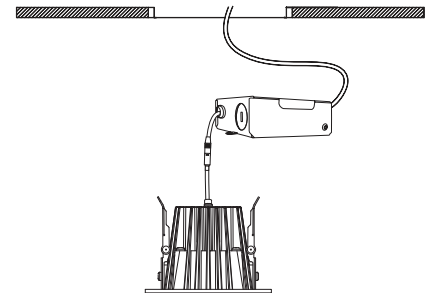

FIG. 4

