



About

ACES Fuel Injection specializes in developing and manufacturing state-of-the-art performance-engine management systems and ignition components geared toward do-it-yourself automotive enthusiasts. Our company was founded on an electromechanical engineering background, and our talented staff stays aware of the newest technology available. We use this expertise to guarantee top-notch quality components and constant innovation of new products and services for car and truck enthusiasts around the world.

Our greatest advantage is the overall simplicity of our products. From a painless installation to real-time tuning in just hours, our fuel injection systems offer a great advantage over the competition. Our JACKPOT™ series GM LS EFI system features a built-in interface that allows users to have full control of the engine without the need of a PC. This allows you to install the system at home without the need for special tools or software. We also offer several other components to help seamlessly integrate our advanced technology into your LS-based vehicle.

Our craftsmanship and technology are built upon a foundation of extreme performance. With a history of producing winning results in a wide variety of applications, our pedigree offers proof of our commitment to attain the best results, wherever we compete. With more than 10 years of experience developing and designing high-performance products, ACES Fuel Injection has a product to fit your needs.

Mission

Research, innovate, and develop real, efficient, quality solutions, making engine management technology the key factor of success, and bring pride and satisfaction to customers by integrating them into the ACES Fuel Injection Team.

Vision

Become the world's leading company in engine management technology.

Values

Ethics, commitment, professionalism, teamwork, quality, pioneering spirit, creativity, continuous innovation, pursuit of results and customer satisfaction.

Table of Cotents

JACKPOT™ EFI OVERVIEW.....	5
ADVANCED USER CAPABILITIES.....	6
WARNINGS, NOTES, AND NOTICES.....	6
1.0 Part List.....	7
2.0 JACKPOT™ MPFI SYSTEM INSTALLATION.....	7
2.1 Fuel system requirements.....	7
2.2 Oxygen Sensor Installation.....	8
2.3 ECU Mounting.....	9
2.4 WIRING.....	9
3.0 Wiring Harness Installation.....	10
3.1 Main Power/Battery Connection.....	10
3.2 ECU Connectors.....	10
3.3 Harness Routing.....	12
4.0 HARNESS INSTALLATION AND SENSOR CONNECTIONS.....	12
4.1 Oil Pressure Sensor.....	12
4.2 Coolant Temperature Sensor (CTS).....	12
4.3 Wideband Oxygen Sensor (WBO1 and WBO2).....	13
4.4 Fuel Pressure (Fuel).....	13
4.5 TMAP.....	14
4.6 Camshaft Position Sensor.....	14
4.7 Crankshaft Position Sensor.....	15
4.8 Knock Sensors.....	15
4.9 Ignition Coils.....	16
4.10 Fuel injectors.....	17
4.11 Handheld.....	18
4.12 LOOSE WIRES.....	18
4.13 ADDITIONAL OUTPUTS.....	18
5.0 TRANSMISSION HARNESS.....	19
5.1 Transmission Wiring.....	19
5.2 Transmission ECU Connector.....	20
5.3 Main Transmission Connector.....	20
5.4 Vehicle Speed Sensor (VSS)/Transmission Output Speed Sensor (OSS).....	20
5.5 Turbine Speed Sensor (TSS).....	20
5.6 Brake Switch (Brown).....	20
6.0 DRIVE-BY-WIRE HARNESS.....	20
6.1 Overview.....	20

6.2 Installation.....	20
6.3 System Safety.....	21
6.4 Throttle Body “Limp Home” Position.....	21
6.5 Drive-By-Wire DOs and DON'Ts.....	21
6.6 Wiring.....	22
7.0 PREVIOUS INSTALLATION REQUIRED.....	23
8.0 QUICKSTART OF JACKPOT™ INSTRUCTIONS AND TUNING.....	23
8.1 INITIAL POWER-UP.....	23
8.2 HANDHELD NAVIGATION & USE.....	23
8.3 Connection.....	25
8.4 Navigation Buttons.....	25
8.5 Home Screen.....	25
9.0 CALIBRATION WIZARD.....	26
10.0 SENSOR VERIFICATION.....	29
11.0 STARTUP ENGINE.....	29
12.0 AFTER STARTUP.....	30
13.0 IDLE SETTING.....	30
14.0 SELF-TUNING.....	30
DIAGNOSTIC LEDS.....	31
TUNING REFERENCE MANUAL.....	31
1.0 System Setting.....	31
1.1 Number of Cylinders.....	31
1.2 Engine Displacement.....	31
1.3 Injector Flowrate.....	31
1.4 Firing Oder.....	32
1.5 Hot Idle Speed.....	32
1.6 Fan control.....	32
1.7 Knock Sensor Numbers.....	32
1.8 Knock Frequency.....	32
1.9 Knock Detect Max/Min Speed.....	32
1.10 Knock Detect Min MAP.....	32
1.11 Crankshaft Type.....	32
1.12 Dual WBOS.....	32
1.13 Drive By wire.....	32
1.14 Transmission Control.....	32
1.15 Transmission type.....	33
1.16 Force TPS Zero Learn.....	33

1.17 Key Off Clear Learn Data.....	33
2.0 SENSOR.....	33
2.1 MAP calibration.....	33
2.2 Other Pressure sensor calibration.....	34
2.3 Temperature Sensors calibration.....	34
2.4 Coolant Temperature sensors (CTS) calibration.....	35
2.5 Manifold Intake Air Temperature sensors (IAT) calibration.....	35
3.0 IDLE.....	35
3.1 Basic Idle Parameter.....	35
3.2 Startup Air.....	36
4.0 SPARK.....	37
4.1 Basic Spark Parameter.....	37
4.2 Knock Parameter.....	38
4.3 Rev limiter Type.....	38
4.4 Spark Correction.....	38
4.5 Base Spark.....	39
5.0 FUEL.....	40
5.1 Basic Fuel Parameter.....	40
5.2 Target AFR Setting.....	40
5.3 Individual Cylinder Fuel Correction.....	40
5.4 Fuel Advanced Setting.....	40
5.5 Fuel Correction and Compensation.....	41
5.6 Startup Fuel.....	41
5.7 Acceleration/Deceleration Fueling.....	41
5.8 Base Fuel MAP.....	43
6.0 FUEL PUMP.....	44
6.1 Turn Off RPM.....	44
6.2 Key-On Pump Hold Time.....	44
6.3 Turn Off After Lose RPM.....	44
7.0 System IO.....	44
8.0 TRANSMISSION.....	45
8.1 Basic Setting.....	45
8.2 TCC Setting.....	45
8.3 Shift Gear.....	46
8.4 Line Pressure.....	47

JACKPOT™ EFI OVERVIEW

The JACKPOT™ ECU delivers advanced engine control capabilities. Through the JACKPOT™ ECU, ACES makes this engine control technology affordable for both professional racers and entry-level consumers.

The JACKPOT™ ECU is built with a 32-bit Power Architecture® based MCU and other IC drivers for automotive powertrain applications. The JACKPOT™ ECU combines a die-cast aluminum housing (for better heat dissipation), automotive-grade chips, a professional 4-layer PCB and high-quality connectors, wiring, and protective sheathing. This allows the JACKPOT™ to be a reliable solution to your engine management needs.

JACKPOT™ ECU features dual Wideband O2 sensors, Closed Loop fuel control, self-learning fuel and ignition control, 8 coil outputs, 8 injector drivers, fan control (high and low speed), boost control, nitrous oxide control, transmission control, drive-by-wire throttle body control, and much more.

JACKPOT™ comes fully loaded with base maps for common GM LS engine combinations to get you out of the garage and on the road or track fast. JACKPOT™ kits include a 5" Handheld LCD display for initial setup. Whether you are building a budget beater or a purpose-built race car, ACES JACKPOT™ EFI kit has advanced features and technology, making it your best choice.

ACES fuel injection JACKPOT™ EFI Features:

- 32-bit Power Architecture® based MCU and others IC drivers' chips for automotive powertrain applications
- Strong anti-interference, high stability hardware and software design
- Speed density-based airflow algorithm strategy
- 58x and 24x-tooth reluctor wheel compatible
- 8 coils signal and 8 injectors drivers (High-Impedance Injectors) Sequential fuel and spark control with individual cylinder trim.
- Self-learning: adaptive idle control (ETC and IAC), adaptive fuel control (3D-map), adaptive ignition control (3D-map).
- Wideband O2 sensor closed loop control and dual internal Lambda controllers (Bosch LSU 4.9 wideband)
- Drive-by-wire electronic throttle body control
- Boost Compatible
- Nitrous timing control
- Dual knock sensing circuits
- Transmission control is suitable for GM 4L60, 4L65, 4L80 or 4L85 transmissions.

JACKPOT™ EFI Kit CAPABILITIES:

- Based airflow speed density models algorithm strategy VE-based fuel map
- Closed Loop fuel control multi-fuel capable
- Transient fuel control (TPS MAP based) Flex fuel compensated
- Boost control strategies (time, gear, vehicle speed, switch and more)
- Drive-by-wire electronic throttle body control (dual H-bridge channels)
- Programmable launch control
- Programmable Rev Limiter control
- Transient condition control (fuel, ignition, and ETC/IAC)
- Target Lambda control for full engine operation
- 2-channel adaptive knock control
- Configurable coil dwell (RPM, voltage and load based)
- Individual cylinder ignition trim (RPM based)
- Individual cylinder fuel trim (RPM based)
- Map switching
- 3D fuel/ignition trim maps (coolant air temperature and ambient pressure)
- Diagnostics: SCB, SCG, OC sensors, coils, injectors, ETC, IAC

*This kit does not work with variable valve timing. These engines can be modified to remove these components.

Thank you for betting on ACES! We are proud to be your manufacturer of choice.

ADVANCED USER CAPABILITIES

The JACKPOT™ software does allow for advanced tuning functionality. A laptop is required to access the advance tuning functions. These functions are not recommended for enthusiasts without extensive EFI tuning knowledge and experience. Making changes to the calibration in the advanced tuning functions can lead to catastrophic engine damage if not done correctly. ACES is not responsible for any damage caused due to advanced tuning errors.

WARNINGS, NOTES, AND NOTICES

NOTE: This system does not contain fuel system components including the fuel pump, fuel filters, fuel pressure regulator, and lines. ACES fuel injection offers complete kits which can be purchased separately (coming soon!).

NOTE: This system is designed for stock and mild cam, naturally aspirated, boosted, and nitrous oxide GM LS engines.

WARNING! The JACKPOT™ MPFI systems consist of several sophisticated components. The failure of any one component does not constitute, nor does it justify, warranty replacement of the complete system. Individual service items are available for replacement of components.

WARNING! To preserve the warranty, these instructions must be read and followed thoroughly and completely before and during installation. It is important that you become familiar with the parts and the installation of the JACKPOT™ MPFI system before you begin. Failure to read and understand these instructions could result in damage to JACKPOT™ MPFI components that are not covered by the warranty and could result in serious personal injury and property damage.

WARNING! The oxygen sensors in this kit are recommended for use with unleaded fuel ONLY. Use of leaded fuels will degrade the oxygen sensor and will result in incorrect exhaust gas oxygen readings and improper fuel delivery. Failure to follow these directions does not constitute the right to a warranty claim.

WARNING! Failure to follow these instructions will result in an improper installation, which may lead to personal injury, including death, and/or property damage. Improper installation and/or use of this or any ACES product will void all warranties.

WARNING! Use of some RTV silicone sealers will destroy the oxygen sensors used with this kit. Ensure the RTV silicone sealant you use is compatible with oxygen sensor vehicles. This information should be found on the RTV package.

WARNING! For the safety and protection of you and others, only a trained mechanic having adequate fuel system experience should perform the installation, adjustment, and repair. It is particularly important to remember one of the basic principles of safety: fuel vapors are heavier than air and tend to collect in low places where an explosive fuel/air mixture may be ignited by any spark or flame resulting in property damage, personal injury, and/or death. Extreme caution must be exercised to prevent spillage and thus eliminate the formation of such fuel vapors.

WARNING! This type of work MUST be performed in a well-ventilated area. Do not smoke or have an open flame present near gasoline vapors or an explosion may result.

WARNING! This installation is not for the tuning novice! Use this system with EXTREME caution! The ACES JACKPOT™ EMS allows for total flexibility in engine tuning. Misuse or improper tuning of this product can destroy your engine! If you are not well versed in engine dynamics and the tuning of engine management systems DO NOT attempt the installation. Refer the installation to an ACES-trained tuning shop or call ACES for technical assistance.

NOTE: All supplied ACES FUEL INJECTION calibrations, wizards and other tuning information are offered as potential starting points only. IT IS THE RESPONSIBILITY OF THE ENGINE TUNER TO ULTIMATELY CONFIRM IF THE CALIBRATION IS SAFE FOR ITS INTENDED USE. ACES FUEL INJECTION holds no responsibility for any engine damage that results from the misuse or mistuning of this product!

1.0 Part List

Item	Description	QTY	Service Part
1	JACKPOT™ ECU	1	AS2011
2	Handheld	1	AS2009
3	Main harness	1	AH2011A
4	Transmission sub harness	1	AH2011-1
5	Coil sub harness	2	AH2011-2
6	Injector sub harness	1	AH2011-3
7	DBW and pedal sub harness	2	AH2011-4
8	Crank and CAM sub harness *58X sub harness 5 volts *24X sub harness 12 volts	2	AH2011-5
9	Knock sub harness	1	AH2011-6
10	Sensor sub harness *include MAP IAT IAC and TPS connector, GM style MAP sensor without PN and AE1040	1	AH2011-7
11	Additional wires	1	AH2011-9
12	Sensor sub harness *include MAP IAC TPS and MAT/IAT connector, MAP is ACES AE1041 2.8 bar.	1	AH2011-10
13	Wideband O2 sensor	2	AE1060
14	2.8 bar TMAP	1	AE1041
15	Clamp-on Oxygen Sensor Bung	2	AE1061
16	MAT/IAT sensor	1	AE1054

2.0 JACKPOT™ MPFI SYSTEM INSTALLATION

2.1 Fuel system requirements

The JACKPOT™ MPFI system requires a high-pressure fuel system providing 58 psi of fuel pressure. The following recommended options are available separately.

NOTE: Fuel pressure has a direct role in how much fuel is delivered to the engine when the injectors are opened. Higher fuel pressure will deliver more fuel during an injector opening event. Lower fuel pressure will deliver less fuel during an injector opening event. It is critical for the proper operation of your fuel injection system that the fuel pressure matches the injector pulse widths demanded by the calibration for your specific application.

Fuel Pressure Regulator Vacuum Reference: The Fuel Pressure Regulator MUST reference manifold pressure to ensure a proper fuel pressure differential during an injector opening event under high vacuum conditions. The vacuum reference will lower fuel pressure slightly under idle and cruise conditions. The amount of pressure reduction will vary from engine to engine. During wide open throttle conditions, the fuel pressure should read the set point value of 58 psi depending on your application. The fuel pressure regulator should always be set to the target pressure with the vacuum reference hose disconnected from the Fuel Pressure Regulator. The hose from the manifold MUST be plugged to prevent a vacuum leak when setting the pressure. Remove

the plug and reconnect the vacuum line to the fuel pressure regulator after target pressure is achieved.

Suggested ACES MPFI Fuel System Kits and Installation

A complete high pressure EFI fuel system must be installed for the ACES JACKPOT™ system. The pump should be capable of supplying 255 L/hr. or 400 lb./hr. of fuel at the JACKPOT™ system requirement of 58 PSI. If using an in-line fuel pump, there should be a 100-micron pre-filter before the pump. All systems should contain a 10-micron post filter after the fuel pump. An EFI fuel pressure regulator is required. It should be installed after the fuel rail.

2.2 Oxygen Sensor Installation

The oxygen sensor should be mounted at a point where it can read a good average of all the cylinders on one bank. This would be slightly after all the exhaust pipes merge. Do NOT mount the sensor far back in the exhaust as this will negatively impact closed loop operation response. If you have long tube headers, mount the sensor approximately 6-10" after the collector. You must have no less than 18–24" of exhaust pipe after the sensor.

JACKPOT™ EMS systems come with a Bosch LSU 4.9 wideband oxygen sensor.

NOTE: JACKPOT™ EFI kits include a pair of wideband O2 sensors. Install the first wideband O2 sensor into exhaust pipe of driver's side bank, then connect to connector labeled WBO1 on the JACKPOT™ harness. Install the other wideband O2 sensor into exhaust pipe of the passenger side bank, then connect to connector labeled WBO2 on the JACKPOT™ harness. Installation and connection must be correct.

NOTE: Never run the engine with the oxygen sensor installed if it is not plugged in and powered by the ECU, or it will be damaged. If you need to plug the hole temporarily, use an O2 sensor plug, or a spark plug with an 18mm thread.

NOTE: Someone with experience in welding exhaust systems should install the oxygen sensor boss. Any competent exhaust shop will be able to perform this task. (Note: If you weld on the car, make sure all wiring to the ECU is disconnected, and it's best to remove the ECU from the vehicle when welding).

WARNING! Use of lead fuel is not recommended as it will damage O2 sensors!

WARNING! Use of some RTV silicone sealers will destroy the oxygen sensor used with this product. Ensure the RTV silicone sealant you use is compatible with oxygen sensor vehicles. This information should be found on the RTV package.

Locate a position for the oxygen sensors as close to the engine as possible. If your vehicle has catalytic converters, the oxygen sensor MUST be located between the engine and the catalytic converters, otherwise air/fuel readings will not be accurate.

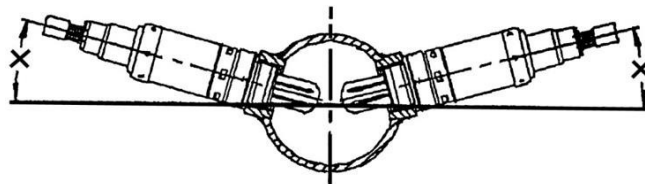

NOTE: The oxygen sensor should be mounted in such a way that the condensation in the exhaust tubing will not enter the sensor. Mount the O2 sensor in the upper half of the exhaust tubing, with the angle "x", shown above, being greater than 10°. Be sure there is enough room around the O2 sensor location to install/remove the sensor with no interference that could damage the sensor or wiring.

Drill a 7/8" hole in the location picked for the sensor. Weld the threaded boss into the 7/8" hole. Weld all the way around the boss to ensure a leak proof connection and allow it to cool. Install the oxygen sensor into the threaded boss and tighten securely. It is recommended to add anti-seize to the threads to aid in removal. Do not get any anti-seize on the tip of the sensor.

On vehicles equipped with an AIR pump, the oxygen sensor must be mounted before the AIR injection into the exhaust, or the AIR pump must be disconnected. ACES recommends that if the AIR is injected into both exhaust manifolds, mount the oxygen sensor into the pipe immediately after the exhaust manifold. Disconnect the AIR pump tube from the exhaust manifold and plug both ends. Check with local ordinances for the legality of this procedure in your area.

* The sensor should be installed in or after the collector. This gives the ECU an average reading across an entire bank instead of from just one cylinder.

* The sensor should not be mounted near the open end of the exhaust system. As this may create exhaust gas reversion giving a false Oxygen content reading to the sensor at lower speeds.

* The system will not function properly if there are any exhaust leaks. Any fresh air that gets to the sensor will cause false lean readings. The ECU will respond by adding fuel that the engine doesn't need.

WARNING! Failure to disconnect the AIR pump or locating the oxygen sensor downstream from AIR injection will result in an extremely rich mixture, which could cause drivability problems and severe engine damage.

2.3 ECU Mounting

The ECU can be mounted inside the passenger compartment (preferable location) or in the engine compartment. If mounted in the engine compartment, follow these guidelines:

The ECU should be located such that water or road debris aren't directly hitting it.

It should also be located such that it isn't extremely close to exhaust manifolds or headers.

It should be mounted such that it is as far away from spark plug wires, CD ignition boxes, or other "electrically noisy" devices as is reasonably possible.

Make sure the connector end of the ECU is pointed DOWN such that water cannot make its way into the ECU terminals. Do not over-tighten mounting hardware if the ECU is not mounted on a flat surface.

2.4 WIRING

This section overviews how to properly install the wiring harnesses for this system.

An EFI system depends heavily on being supplied with a clean and constant voltage source. The grounds of an electrical system are just as important as the power side.

JACKPOT™ ECU's contain multiple processing devices that require clean power and ground sources. The wiring harnesses for them must be installed in such a manner that they are separated from "dirty" power and ground sources.

- Install the main power and ground directly to the battery POSTS/TERMINALS, not to any other place!

Keep sensor wiring away from high voltage or "noisy/dirty" components and wiring, especially secondary ignition wiring (plug wires), ignition boxes, and associated wiring. It is best that the plug wires do not physically contact any EFI wires.

- Properly crimp or crimp and solder any wire connections. Apply quality heat shrink over any of these connections.

- It is critical that the engine has a proper ground connection to the battery and chassis.

NEVER run high-voltage or "noisy/dirty" wires in parallel (bundle/loom together) with any EFI sensor wiring. If wires need to cross, try to do so at an angle.

- Do not use the electric fan outputs to directly power a fan. They must use a ground trigger relay.

- Do not use improper crimping tools.

- Do not use things like "t-taps", etc. Use proper crimpers/solder and heat shrink.

- It is never recommended to splice/share signal wires (such as TPS, etc.) between different electronic control units (i.e., "piggyback").

- Do not connect the red/white switched +12V wire to "dirty" sources, such as the ignition coil, audio systems, or 12V sources connected to HID head lamps.

3.0 Wiring Harness Installation

3.1 Main Power/Battery Connection

The JACKPOT™ ECU has a main battery power connector labeled 12V Battery + (red) and ground connector labeled 12V battery - (black) on the Main harness. The loose wires of the JACKPOT™ harness located approximately 20" from the ECU connectors are the power (red wire) and ground (black wire), which should be connected DIRECTLY to the positive and negative battery terminals. If you have a "dual post" battery, it is a great idea to purchase separate posts/studs to connect the ECU power and ground to the non-used terminals. Only use the fused power cable with the proper connectors supplied by ACES. Do not connect to the ECU until after ALL wiring and installation is performed.

3.2 ECU Connectors



JACKPOT™ ECU has one 94 pins connector:

PIN	DEFINATION		PIN	DEFINATION	
1	GND		48	FAN2	
2	GND		49	LINE PRESSURE	
3	Vmain		50	TCC_CONTROL	
4	Vmain		51	Vmain	
5	ETC2		52	S5V	
6	ETC1		53	KS2	
7	HT1		54	MAP	
8	Rev in2		55	PPS	
9	AC_REQ		56	IAT	
10	Range B		57	VSS	
11	S5V_1		58	APE1	
12	ATF		59	RE1+	
13	CTS		60	APE2	
14	Rev in5		61	CD1	
15	Rev in3		62	VR1-	
16	RT1		63	OUTA	
17	AGND		64	OUTB	
18	FAN1		65	IGN7	
19	RLY2		66	IGN3	
20	VVT1		67	VR2-	

21	RLY1		68	3-2 SOLENOID	
22	AC Clutch		69	INJ5	
23	SOL A		70	INJ1	
24	SOLB		71	MRD	
25	TCC CONTRID		72	VVT2	
26	INJ8		73	VMAIN	
27	IGN5		74	S5V	
28	INJ7		75	KS1	
29	HT2		76	GND	
30	Rev in1		77	PPSRD	
31	Range C		78	OPS	
32	Range A		79	TURBINE SPEED	
33	TPS		80	IGNSW	
34	TPSRD		81	IPN1	
35	FPS		82	BAT	
36	Brake SW		83	CD0	
37	Rev in4		84	IPN2	
38	RE2+		85	VR1+	
39	RT2		86	OUTC	
40	AGND		87	OUTD	
41	TACHOUT		88	IGN6	
42	IGN8		89	IGN4	
43	RLY PUMP		90	VR2+	
44	ING2		91	INJ6	
45	ING1		92	INJ2	
46	CANH		93	INJ3	
47	CANL		94	INJ4	

3.3 Harness Routing

If the ECU is mounted in the interior, the main harness will have to be routed through the firewall into the engine compartment. Use a 2" hole saw to create a hole in a desired location if no other point of access is available. Use a grommet for a 2" hole to seal this area.

If the ECU is mounted in the engine compartment, the cable to the 5" handheld will have to be routed to the CAN connector on the main harness (located near the ECU main connector). This is assuming you want to access the hand-held module after startup. This will require routing the small CAN connector somewhere through the firewall.

4.0 HARNESS INSTALLATION AND SENSOR CONNECTIONS

The following indicates the primary sensors that are required to be connected. Each connector on the main harness is labeled with the sensor name. The name on this label for each sensor is in parenthesis below.

4.1 Oil Pressure Sensor

Connect to the factory oil pressure sensors located at the rear of the engine. NOTE: LS2 GTO & F-Body Oil Pressure sensors have a unique pin-out and cannot be used with the JACKPOT™ Harness.

ACES EFI pressure sensor kits are top-quality parts for use with ACES EFI systems. These kits include plastic/steel sensors that have 1/8 in.-27 NPT threads and include a -6 AN fuel pressure take-off adapter fitting and 2 sets of 45 push lock hose ends.

Pressure sensors are great for logging oil pressure, fuel pressure, boost pressure. displaying pressure on the Handheld or Dash screen and on your data log files.

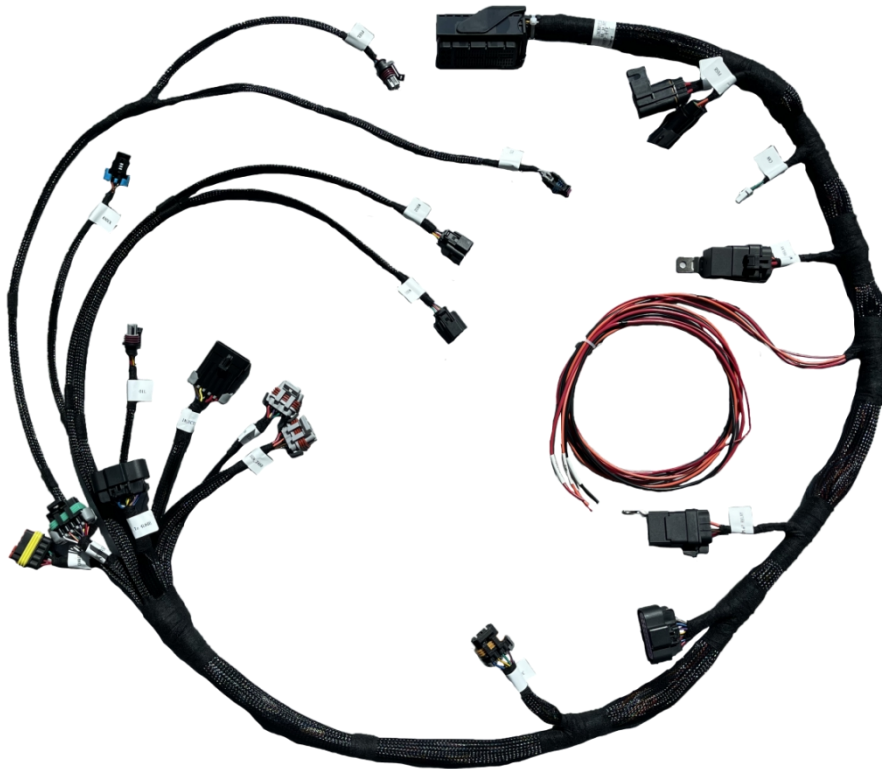

JACKPOT™ Main Wire Harness AH2011

4.2 Coolant Temperature Sensor (CTS)

Connect the CTS connector to the sensor, which should be in the front of the driver's side cylinder head.

CTS is specifically designed for temperature measurements in automotive systems.



Coolant Temperature Sensor Connector

NOTE: Default CTS calibration data in JACKPOT™ ECU is GM LSX CTS sensor.

4.3 Wideband Oxygen Sensor (WBO1 and WBO2)

Connect to the oxygen sensor previously installed. There is an adapter harness included in the kit which allows the Bosch 4.9 sensor to plug into the main engine harness. If you need an extension cable, one is available from ACES AE1060. The JACKPOT™ systems are intended to be used with a Bosch LSU 4.9 wideband oxygen sensor supplied by ACES.

JACKPOT™ kits have two sensors, one for each bank. One sensor should be installed in exhaust pipe on the driver side, another one should be installed in exhaust pipe on the passenger side. Plug wire connector labeled **WBO2 1** into oxygen sensor on driver side, plug wire connector labeled **WBO2 2** into oxygen sensor on passenger side



Dual Wideband O2 sensor Connectors

4.4 Fuel Pressure (Fuel)

A fuel pressure transducer connector (optional) is pre-installed in the main harness. If these are not connected to a pressure transducer, the fuel pressure shown on the handheld display will not be accurate. However, this will not cause any performance issues. Connect to the transducer (if installed).



Fuel Pressure Sensor Connector

ACES EFI pressure sensor kits are top-quality parts for use with ACES EFI systems. These kits include plastic/steel sensors that have 1/8 in.-27 NPT threads and include a -6 AN fuel pressure take-off adapter fitting and 2 sets of 45 push lock hose ends.

Pressure sensors are great for logging oil pressure, fuel pressure, boost pressure. displaying pressure on the Handheld or Dash screen and on your data log files.



4.5 MAP

JACKPOT™ EFI system kits include ACES 2.8Bar MAP sensor and AE1054 MAT sensor.

Many other MAP sensors can be configured for use with JACKPOT™ ECU but will require custom calibrations to be made via software.



Manifold Temperature and Pressure Sensor Connector

Sensor sub harness

*include MAP IAT IAC and TPS connector, GM style MAP sensor without PN and AE1040, part No.AH2011-7

Sensor sub harness

*include TMAP IAC and TPS connector, MAP is ACES AE1041 2.8 bar, part No.AH2011-10

4.6 Camshaft Position Sensor

The camshaft position sensor is used to calculate engine position. It is necessary for sequential fuel calculations. It senses a toothed wheel (reluctor wheel, reluctor ring, etc.) and converts this pattern into a voltage/frequency signal that the ACES EMS uses for basic calculations. Combined with the crank position sensor, it is one of the most important inputs to the system. There are two basic types of cam sensors, variable reluctance (VR or “mag”) and hall-effect.

All VR Camshaft Position Sensor inputs to the JACKPOT™ ECU must be connected such that the rising edge of the raw sensor signal is the consistent zero crossing edge. Failure to do this could result in misfires or ignition timing inaccuracies. Verify data with an oscilloscope or contact your sensor manufacturer to verify polarity.

The camshaft position sensor of LS engines is in one of two locations depending on whether the harness is for a 24x or 58x reluctor wheel. If 24x, the camshaft position sensor is located on top at the rear of the block, at the back of the intake manifold. If 58x, the cam sensor is in the timing cover on the driver’s side. The ACES harness plugs directly into the sensor, not the short pigtail that may be on the engine.

4.7 Crankshaft Position Sensor

The crankshaft position sensor is used to calculate engine speed, ignition timing, and injection phasing angles. It senses a toothed wheel (reluctor wheel, reluctor ring, etc.) and converts this pattern into a voltage/frequency signal that the EMS uses for basic calculations. Either on its own, or combined with the cam position sensor, it is the most important input to the system. There are two basic types of crankshaft position sensors, variable reluctance (VR or “mag”) and hall-effect.

The crankshaft position sensor harness should be bundled in heat shielding for protection. The crankshaft position sensor is located behind the starter. It is imperative this harness routed away from heat sources. Connect to the crankshaft position sensor.

The JACKPOT™ EFI system has two detachable sub harnesses™ for crankshaft and camshaft position sensors for 24x and 58x reluctor wheel applications.



24x Reluctor Wheel Sub harness AH2011-5



58x Reluctor Wheel Sub harness AH2011-5

4.8 Knock Sensors

Connect to the Knock Sensor(s). Earlier model LS engines will have a knock sensor located in the center valley of the engine. Later model LS engines have knock sensors located on the bottom of the block near the oil pan rails. Knock Sensors are not enabled in JACKPOT™ base calibrations but may be configured by using ACES EFI software.

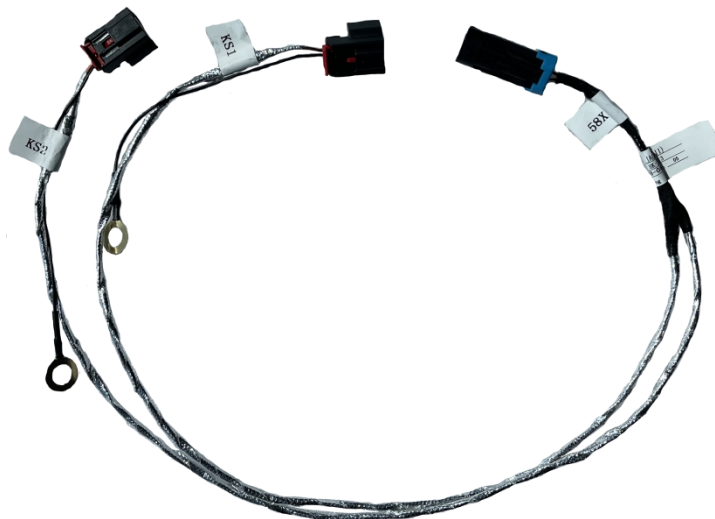

Knock sub harness AH2011-6

The knock sensor connector (pictured above) is used in earlier GM LS engines. Later model GM LS engines have two knock sensors. ACES includes a detachable dual knock sensor sub harness for JACKPOT™ EFI kits

4.9 Ignition Coils

ACES IGBT Smart Coil

The JACKPOT™ ECU can support most OE and aftermarket smart coils, but ACES EFI highly recommends ACES smart coils (PN AC2011) for use with the JACKPOT™ EFI system. Connect the coil connectors into the coil harness. This coil harness is connected into each ACES smart coil.

High Performance Coil

Connect the coil connectors into each bank of coils. The driver side connector should be labeled “IGN_1357”. The passenger side connector should be labeled “IGN_2468”. Make sure these are properly connected. If they are not, the firing order will not occur correctly, and damage could result.

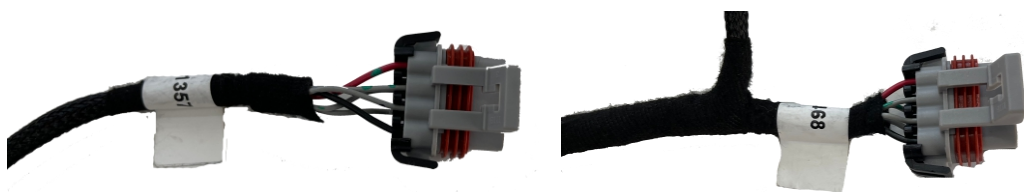

Ignition Coil Connector

Make sure these two connectors are plugged into detachable coil sub harness (AH2011-2) correctly. If they are not, the firing order will not occur properly, and damage could result.

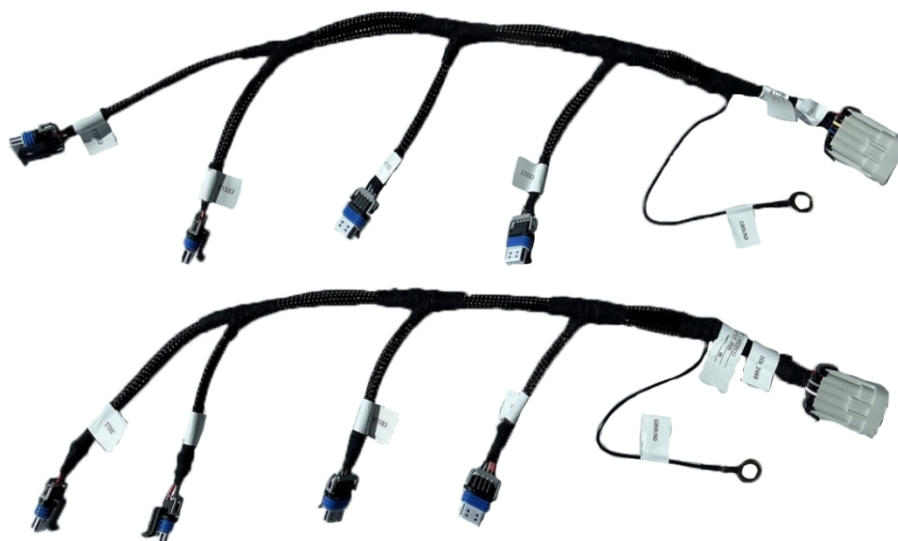

Coil Sub Harness AH2011-2

ACES Performance Coil

NOTE: ACES recommend FULL HOUSE™ CDI and High-Performance Coils with JACKPOT™ EFI kits.

Connect connector labeled “IGN_1357” to the connector labeled “ODD” on the FULL HOUSE™ CDI harness; connect connector labeled “IGN_2468” to the connector labeled “EVEN” on the FULL HOUSE™ CDI harness.

ACES FULL HOUSE™ CDI gives you powerful spark energy (over 750 mJ), with eight-channel ignition control. The spark energy of ACES performance coils (AC2010) is 200mJ. The combination of ACES JACKPOT™ EFI and FULL HOUSE™ CDI Ignition help your engine achieve higher performance levels.

4.10 Fuel injectors

The JACKPOT™ is compatible with high-impedance injectors only. For direct-drive operation, injector coil resistance must be greater than 8 ohms.

ACES EFI recommends its 36 lbs./hr. fuel injectors (PN AE1001) with 58 PSI base fuel pressure for your LS engine, which can support over 500hp. If your engine combination requires larger injectors, ACES OEM quality fuel injectors are your best choice.

ACES Injector	Flowrate
AE1001	36.00 lb/hr
AE1002	65.00 lb/hr
AE1003	80.00 lb/hr
AE1004	100.00 lb/hr
AE1005	211.00 lb/hr

The detachable injector sub harness has EV6 connectors. The injection strategy of JACKPOT™ ECU is sequential, make sure to plug each injector connector into the corresponding injector, otherwise you will damage your engine.

The JACKPOT™ ECU has dual lambda control and wideband O2 sensors for each bank of your V8 engine. Connect injector harness to the corresponding injectors. Connect the WBO1 connector to the driver side wideband O2 sensor, then connect the WBO2 connector to passenger side wideband O2 sensor. These installation operations are critical to ensuring the JACKPOT™ ECU closed loop strategy works properly.

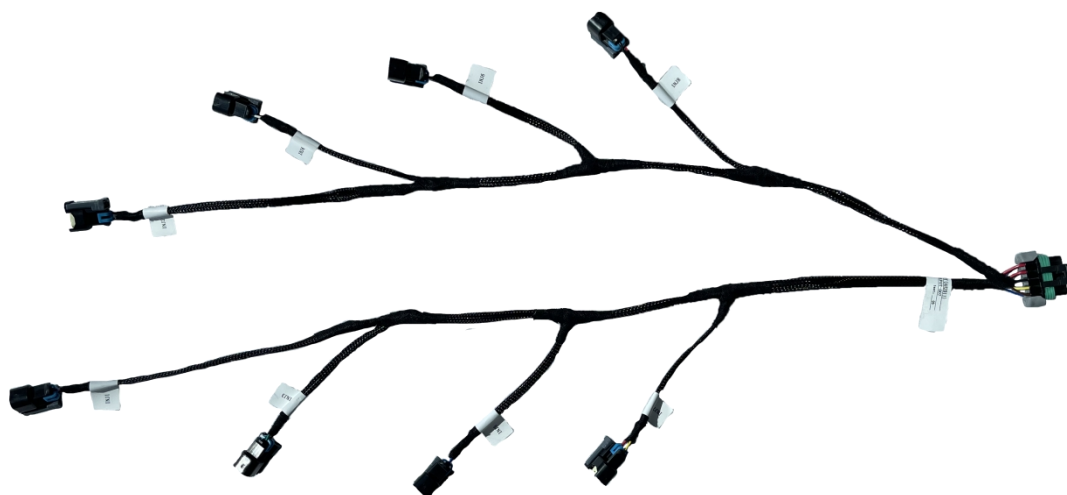

Fuel Injector Harness

4.11 Handheld

The handheld controller is used to create the initial calibration for the system, allows for simple tuning changes during regular operation, and is also used to view various real-time data of the EFI system. It should be installed such that the handheld controller can be easily used in the passenger compartment. The handheld plugs directly into the main harness at either connector labeled “CAN.” This connector is located approximately 12” from the ECU connector. The handheld does not have to remain in the vehicle or be utilized after the vehicle is set up and running properly.



CAN Bus connector

4.12 LOOSE WIRES

The following loose wires in the main wiring harness should be connected as follows on all systems.

IGNSW (Red) Should be connected to a clean key-on/cranking +12V power source. Power source should only be active when the ignition is on (key-on power). Make sure the source has power when the engine is cranking as well (check with voltmeter). Not all sources apply power when the ignition switch is in “cranking” position. This wire is located approximately 20” from the ECU connectors. DO NOT connect to a “DIRTY” source like an ignition coil!

12V Battery + (Red) MUST be connected directly to the positive battery terminal. This powers the fuel pump and fuel injectors. This wire is protected by a fuse in a sealed fuse holder. The fuse holder is located about 8" from the ECU connector. A 20-amp (20A) fuse is pre-installed.

12V Battery - (Black) MUST be connected directly to the negative battery terminal. Using a traditional chassis ground can cause electrical issues with the JACKPOT™ ECU. This wire is located approximately 20” from the ECU connectors.

4.13 ADDITIONAL OUTPUTS

JACKPOT™ ECU base calibrations are pre-configured with 3 outputs and one input to be used for the following features:

VMAIN (Red) – This output will provide a 12V power supply from the main relay. This wire is located approximately 32” from the ECU connectors.

Tach out (Orange) This wire provides a 12V square wave output and can be used to trigger a conventional tachometer.

Fuel Pump (Orange) (+12V) Do not use this wire to power fuel pumps that require over 15 Amps. Refer to your fuel pump manufacturer for amperage ratings. For high current pumps, use this wire to trigger a separate relay and use larger gauge wire to feed the pump - 10 gauge is recommended. The fuel pump will also require a ground wire. Run a wire from the negative side of the fuel pump. Connect it to a solid chassis/frame ground.

Fan1 (Purple) This output will provide a ground output to trigger a relay used for a cooling fan. This output should never be directly connected to a fan, but the relay that powers the fan. It should be connected to the ground trigger of the relay. This wire is located approximately 32” from the ECU connectors.

Fan2 (Green) This output will provide a ground output to trigger a relay used for a cooling fan. This output should never be directly connected to a fan, but the relay that powers the fan. It should be connected to the ground trigger of the relay. This wire is located approximately 32” from the ECU connectors.

AC-REQ (Yellow) – This input should receive 12V when the AC is on. This input tells the ECU to raise the engine idle speed for the increased load when the AC compressor engaging. The input can also signal a high-speed fan to turn on. This functionality needs to be turned on in the fan setting using the JACKPOT™ handheld controller. This wire is located approximately 32” from the ECU connectors.

Burn (Color = Yellow) Burn out Rev Limiter, feeding 12 V power to this wire tells the ECU that a burn out control has been activated.

Launch (Color = Blue) Launch Rev Limiter, feeding 12 V power to this wire tells the ECU that a Launch control has been activated.

Step (Color = Brown) Step Retard, feeding 12 V power to this wire tells the ECU that a step retard has been activated.

Power en (Color = Red) 12v power to alternator

Brake Switch (Color = Brown) Wired to the brake light switch. This must be installed to a +12v source (as most brake light switches are). This input is used to unlock the torque converter when the brakes are applied.

VSS (Color = Blue) Vehicle Speed sensor input, Located on the rear driver’s side on a 4L80E and the rear passengers’ side on a

4L60E.

Fuel Level (red) This is a fuel level sensor input resistance that can go from 0-250 or from 250-0, it can represent the percentage of fuel in the tank.

REV (Blue) Optional - Programmable ground output



5.0 TRANSMISSION HARNESS

5.1 Transmission Wiring

The transmission harness can be used on GM 4L60E, 4L65E, 4L80E, and 4L85E transmissions. Each connector is labeled.



Transmission Harness

5.2 Transmission ECU Connector (B1)– Plugs into the C7 connector on the JACKPOT™ main wire harness AH2011A. Plugs into the last connector opposite the main harness.

5.3 Main Transmission Connector – Plugs into the connector on the transmission on the driver’s side of 4L80E (installed horizontally) and the passenger side of 4L60E (installed vertically).

5.4 Vehicle Speed Sensor (VSS)/Transmission Output Speed Sensor (OSS) – Located on the rear driver’s side on a 4L80E and the rear passengers’ side on a 4L60E

5.5 Turbine Speed Sensor (TSS) – The 4L60E does not have a turbine speed sensor. For 4L80E applications, it is located towards the front driver’s side of the transmission. NOTE: the 4L70E has an internally wired TSS, but it does not connect to the JACKPOT™ harness. The TSS is not used for calibration in the ECU, just for monitoring purposes.

5.6 Brake Switch (Brown) – Wired to the brake light switch. This must be installed to a +12v source (as most brake light switches are). This input is used to unlock the torque converter when the brakes are applied.

6.0 DRIVE-BY-WIRE HARNESS

WARNING!

Use only the unmodified drive-by-wire wiring harness supplied by ACES. THIS HARNESS CAN NOT BE CUT, SHORTENED, LENGTHENED, TAILORED, OR MODIFIED UNDER ANY CIRCUMSTANCE! THE HARNESS CONTAINS PROTECTIVE SHIELDING / GROUNDED CABLING TO ENSURE PROPER OPERATION. DO NOT REMOVE OR MODIFY THE PROTECTIVE SHEATHING UNDER ANY CIRCUMSTANCES. ACES ASSUMES NO LIABILITY FOR ANY INSTANCES ARISING DUE TO USE OF THROTTLE PEDALS, THROTTLE BODIES, OR ASSOCIATED COMPONENTS NOT SPECIFICALLY APPROVED BY ACES FUEL INJECTION.

6.1 Overview

The JACKPOT™ ECU has built-in capability to control OEM type Drive-By-Wire throttle pedals and throttle bodies for aftermarket installation.

6.2 Installation

A professional, competent mechanic should perform installation of both the drive-by-wire throttle body and pedal assembly. It is important that the installation of both the throttle body and pedal assembly on an engine (not originally equipped with these components) be done in such a manner that assures proper operation of both components as intended by the OEM.

The throttle body must be installed in such a manner that the throttle plate(s) are allowed to rotate freely.

The pedal assembly must also be installed in such a manner that it is rigidly and securely mounted, yet does not put the pedal in a bind, or put any mechanical stress on the electrical and electronic components. Proper positioning of the pedal is of the utmost importance.

The accelerator pedal must have adequate clearance throughout its range of travel to prevent the possibility of the pedal from contacting any item that may cause it not to return to the “idle” position upon release. The accelerator pedal must also be mounted far enough away from the brake pedal as to allow for the vehicle’s brakes to be fully applied without the operator’s foot contacting the DBW pedal.

The drive-by-wire pedal should be in a position such that it is lower than the brake pedal when the brake pedal is depressed.

Installation of the wiring harness supplied by ACES must be done so that there is no chance the wiring may be cut or abraded. Rubber grommets should be utilized wherever the harness passes through a firewall / sheet metal panel.

The DBW harness should never be routed in such a manner that it may contact or come close to “noisy” electrical components or wiring that may emit RFI and/or EMI noise. Typical “noisy” components and associated wiring in a vehicle would be spark plug wires, ignition coils, high energy ignition boxes, audio equipment (including CB’s), etc. Maintain a minimum of 5” of clearance to any of these types of components.

The harness is designed to be “plug-and-play” with the throttle bodies and pedal assembly indicated above. It should not be used for any other applications.

6.3 System Safety

IMPORTANT! INSTALLATION OF THIS SAFETY CIRCUIT IS REQUIRED WHEN USING THE DRIVE-BY-WIRE FEATURE! NEGLECTING TO INSTALL THIS INPUT IS DONE AT THE USERS OWN RISK. THE USER ASSUMES ANY AND ALL LIABILITY FOR ANY DAMAGE, AS A RESULT OF A DRIVE-BY-WIRE MALFUNCTION.

Most drive-by-wire systems are designed so there are two position sensors, one on the throttle body and one on the accelerator pedal assembly. This is done as a failsafe if one of the position sensors fails. Aces JACKPOT™ EFI systems require both sensors function properly. If any sensor moves from its calibrated position, the throttle body is immediately de-powered, forcing it to move to the factory “limp home” position. The “limp home” position is described in detail below.

6.4 Throttle Body “Limp Home” Position

Factory Drive-By-Wire Throttle Bodies have a “Limp Home” position. This is the position that the throttle body is at when no power is applied. It is typically enough air flow to allow a car to move at a speed of approximately 45 mph. This varies by manufacturer but is the case with the GM throttle bodies this harness supports.

It should be strongly noted that this position allows MORE airflow than the engine uses for an idle position. If the throttle body goes into a “limp home” position due to a sensor failure or other reason, the engine will have more air and result in more power. This will require more brake pressure to be applied if a vehicle is in gear so that it does not move.

6.5 Drive-By-Wire DOs and DON'Ts

DO

- Use only the ACES-supplied harness.
- Have the pedal, throttle body, and harness installed by a competent professional.

DON'T

- Do not cut, shorten, lengthen, or otherwise modify the drive-by-wire harness for any reason!
- Do not run the drive-by-wire harness past high voltage or “noisy” sources
- Do not use this system if the pedal is not securely mounted as described in the instructions above. It must be SOLIDLY mounted with adequate room for safe and proper operation.
- Do not use this system if the throttle body is not properly mounted or has any potential of interference/binding of the throttle plates.
- Do not start the engine unless everything is operating properly.

6.6 Wiring

LS Engines came with two styles of connectors for their DBW throttle bodies: An 8-pin connector (early truck) and a 6 pin (passenger car and 2007+ truck).

ECU connector – plug into connector C14 on the JACKPOT™ wire harness AH2011

Pedal Connector – plug into the throttle pedal

Throttle Body Connector – plug into the DBW throttle body.

Brake Switch Wire – This MUST be connected to a +12v input from the brake pedal switch.

There are two styles of DBW throttle body connectors. The following part numbers are supported by Aces Jackpot LS EFI kits:

APPROVED GM THROTTLE BODIES:

- ✓ GM Part # - 12570800
- ✓ GM Part # - 12570790
- ✓ GM Part # - 12580760
- ✓ GM Part # - 12580195
- ✓ GM Part # - 12605109
- ✓ GM Part # _ 12629992

APPROVED GM THROTTLE PEDAL ASSEMBLIES:

- ✓ GM Part # - 10379038
- ✓ Lokar Part # - BDBW-GM02



8-pin connector DBW Sub harness



6 pin connector DBW Sub harness

7.0 PREVIOUS INSTALLATION REQUIRED

Once all harnessing has been connected, the installation of your EFI system should be 100 percent complete. The ECU, JACKPOT™ Handheld controller, throttle body and intake hardware, all sensors, wiring, fuel pump, regulator and return line, and all other hardware should be installed. The vehicle should be ready to start and run. If this is not the case, refer to the hardware installation manual included with your specific system.

8.0 QUICKSTART OF JACKPOT™ INSTRUCTIONS AND TUNING

The JACKPOT™ EFI systems are designed to be easy to use for the first time EFI tuner. The instructions are set up in that manner as well. These instructions will not go into detail about EFI theory and operation. They will provide the steps necessary to get you up and running quickly. The JACKPOT™ EFI system allows for the user to perform some basic changes to the tuning if they desire to do so.

The instructions are sequenced to get you up and running so you can enjoy your vehicle, then review some of the parameters that can be adjusted to fine tune your vehicle later, if desired.

8.1 INITIAL POWER-UP

Turn the ignition key to the “run” position. This should apply power to the ECU, as well as to the ACES Handheld control module. The handheld should power up and the Home Screen should appear. At this time, you should hear the fuel pump cycle on and run for 5 seconds. Check for fuel leaks before moving forward.

The Home screen contains icons which will navigate to different functional features of the 5” Touch Screen. These features will be discussed in detail throughout this manual.

8.2 HANDHELD NAVIGATION & USE

The handheld is composed of a 5.0" capacitive touch screen with six physical buttons. The handheld is equipped with a robust color LCD display with a large screen size. There are navigation buttons on either side of the screen. The external interface is CAN bus- and USB-C-based. All operations can be done by touching the screen or the physical buttons on either side.

The handheld can be used to calibrate the system and to monitor engine data (engine RPM, AFR targets, battery voltage, etc.) when it is connected to the ECU. It is very portable and can be connected to ECU for monitoring and calibration at any time.

There are buttons on either side of the display, which activate different functions and operations within the system. The user can operate the scan tool by touching the screen or the buttons on either side, such as switching the interface and modifying the calibration data, upload/download calibration data, etc.

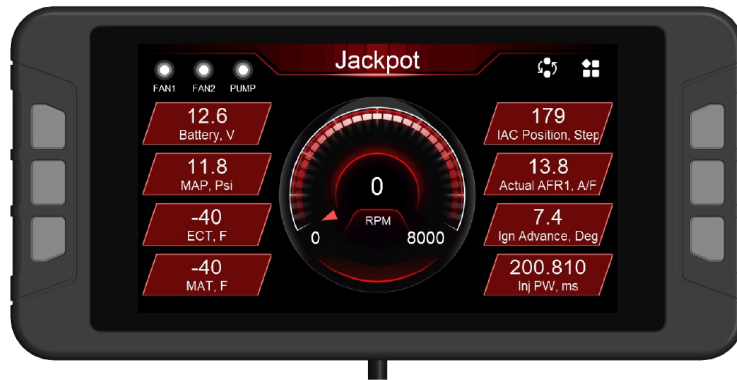

Making Adjustments

(1) Slider Bar: Slide the bar or click "◀" and "▶" on the touchscreen to adjust the parameters, click "📁" to save, and click "↶" to cancel saving

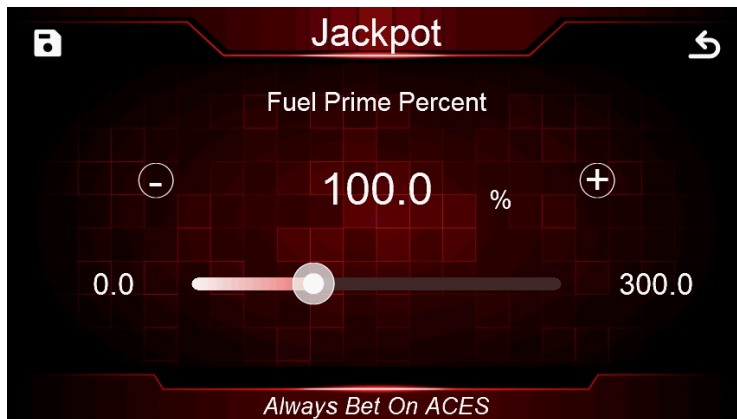

(2) Numeric keyboard: Click the edit box "100.0%" above the sliding bar to pop up the numeric keyboard.

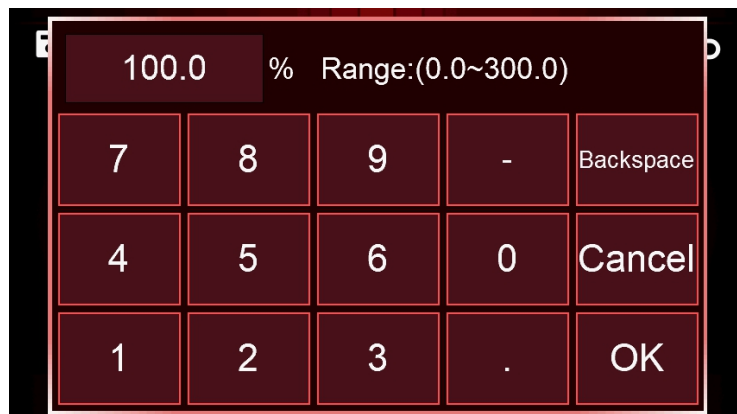

(3) 2D Graph: Drag the red dot on the graph or click the mechanical buttons on both sides to adjust the parameters. When adjusting the parameter, the y-axis coordinate value of the currently adjusted parameter will be displayed in the upper right

corner. The four buttons on both sides of the interface will disappear after a short display. Clicking the two mechanical buttons at the lower left corner can switch the position of the green dot, clicking the button at the right center can raise the position of the green dot, and clicking the mechanical button at the lower right corner can lower the position of the yellow dot. The y-axis coordinate value of the green dot is displayed in the upper right corner of the interface.

After the configuration is complete, click "📁" to download the calibration data to the ECU; click "↶" to cancel the modification.

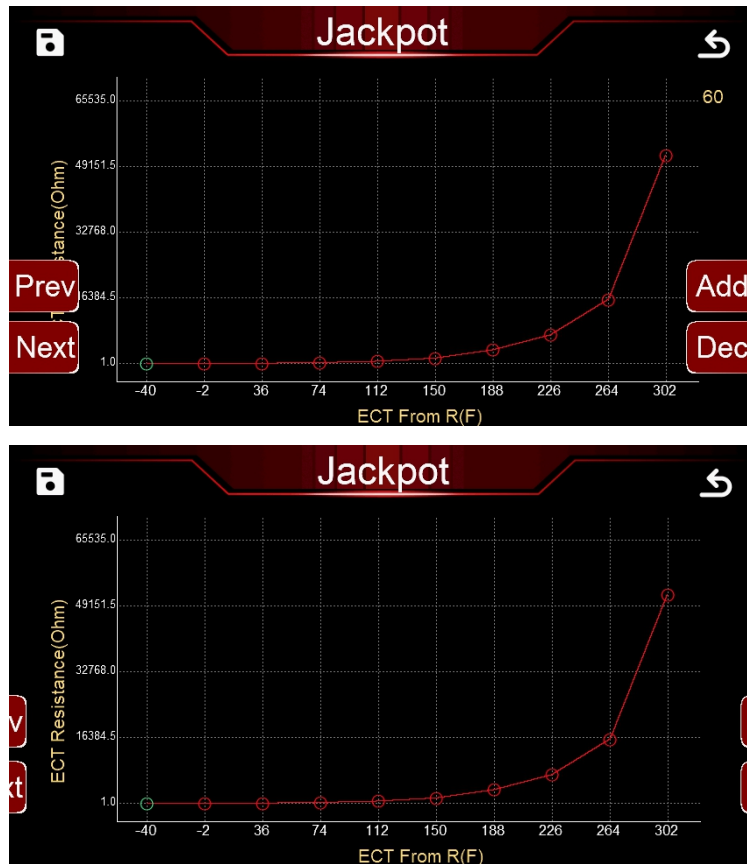

8.3 Connection

The handheld connects to the ECU through the CAN bus connection, and its software can be updated through the Type-C USB interface when needed.

8.4 Navigation Buttons

ACES designed its handheld controller for reliable operation and easy use. There are buttons on either side of the display, which operate different interfaces within the system. The user can operate the scan tool by touching the screen or the buttons, such as switching the interface and modifying the calibration data, upload/download calibration data, etc.

8.5 Home Screen



The home screen has 6 icons that direct the user to different functions.

Monitor - A variety of gauge and dash displays.

Calibration - Allows for various parameters to be easily adjusted.

Logging - The user can freely choose the monitored object to write to the log file in order to better observe the ECU data.

File - Saves and loads calibrations. Also shows information about the ECU and handheld controller.





Setting - The local settings can adjust the backlight brightness, sound volume of button or touch, and information about the handheld.

Wizards - Creates a base calibration and performs the TPS Zero Auto learn function.

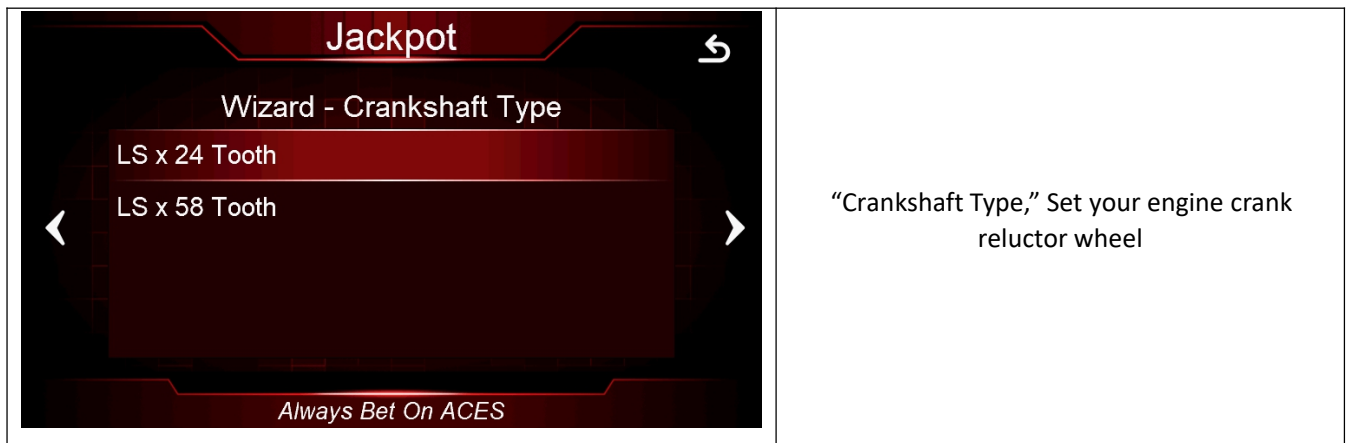
The JACKPOT™ EFI system will build a custom calibration for your engine based on a few easy-to-answer questions. To begin, Choose the “Wizards” icon from the main menu.

9.0 CALIBRATION WIZARD



 <p>Jackpot</p> <p>Wizard - CAM Type</p> <ul style="list-style-type: none"> System Default Stock Mild Race <p>Always Bet On ACES</p>	<p>"CAM Type"</p>
 <p>Jackpot</p> <p>Wizard - MAP Type</p> <ul style="list-style-type: none"> TMAP AE1036 MAP AE1040 MAP ACDELCO 12614970 MAP AE1041 <p>Always Bet On ACES</p>	<p>"MAP Type"</p>
 <p>Jackpot</p> <p>Wizard - Dual WBOS</p> <ul style="list-style-type: none"> Only WBOS1 Dual WBOS <p>Always Bet On ACES</p>	<p>"Dual WBOS"</p>
 <p>Jackpot</p> <p>Wizard - Drive By Wire</p> <ul style="list-style-type: none"> NO YES <p>Always Bet On ACES</p>	<p>"Drive By Wire"</p>



"Transmission Control", the "YES" item will be enable and the "NO" is disable Trans control function.







"Transmission Type"



"Number Of Cylinders"

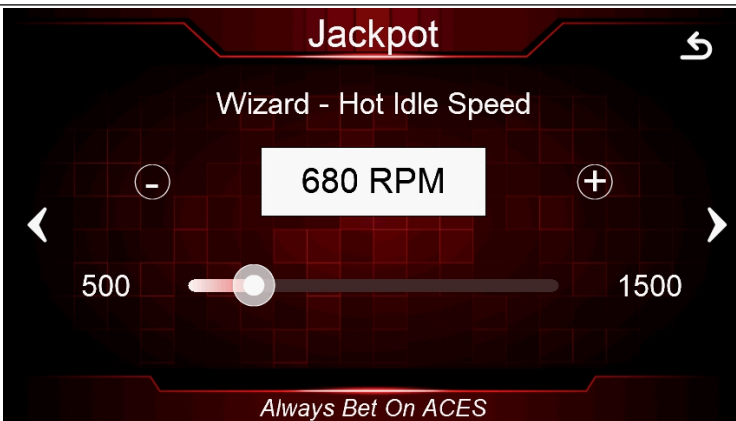

"Injector Flowrate"

	<p>"Engine Displacement"</p>
	<p>"Firing Order"</p>
	<p>"Hot Idle Speed"</p>
	<p>Click "📁" to save the configuration to the ECU, click "↩" to return to wizard for modifying configuration, click "🏠" to return to the main menu.</p>

10.0 SENSOR VERIFICATION

Before starting the vehicle, verify that every sensor is reading properly. Turn the key off and cycle it back on. At this time, you will hear the fuel pump cycle on and run for 5 seconds. Check again for fuel leaks.

On the Home Screen, With the key on and the engine off, these sensors should read as follows:

Engine RPM – Will show “0” when not cranking.

MAP (Manifold Air Pressure) – Should read between 95-102. At high elevations it could read as low as 75.

TPS (Throttle Position Sensor) – Slowly depress the throttle to wide open. It should read 100 at wide open throttle. Cable operated throttle bodies should read 0 closed.

CTS (Coolant Temperature Sensor) – reads engine temperature. If the engine is “cold,” it should read close to ambient temperature.

Battery – Will read battery voltage. It should be 12.0 volts minimum.

NOTE: If ANY of these sensors are not reading properly DO NOT attempt to start the engine.

11.0 STARTUP ENGINE

With each sensor reading properly, the vehicle should be ready to be started. Open the Home Screen and make sure the TPS is reading 0. If it does not, do a TPS Zero Learn or if it is reading 1-2%, close the idle screw on the throttle body slightly till the TPS reads “0”.

Crank the engine and look at the RPM parameter. It should indicate the engine RPM while cranking. The engine should start and idle. Engine cold start will have a higher RPM (around 1,200-1,500 RPM) and should come to the commanded idle speed as the engine temperature increases.

If there is no RPM signal, confirm wiring connections are correct and verify system setup. Call ACES Fuel Injection Technical Support if the problem persists.

12.0 AFTER STARTUP

Once the vehicle has started, look for any fuel or coolant leaks. Let the vehicle come up to normal operating temperature and monitor the engine parameters to ensure proper operation.

Fuel Loop1 State and Fuel Loop2 State – Indicates whether the engine is operating in “Closed Loop” or “Open Loop”. Closed Loop indicates that the ECU is adding or subtracting fuel to maintain the target air/fuel ratio. The JACKPOT™ calibrations are such that the system should most often be operating closed loop.

Injector Percentage – This is the percentage of fuel compensation that the ECU is adding or subtracting to maintain the target air/fuel ratio at any specific moment. A value of less than 100% indicates that the ECU is removing fuel. A value more than 100% indicates that the ECU is adding fuel. When in Open Loop operation, the Injector Percentage will always stay at 100%.

Target Air/Fuel Ratio – This is the target AFR (air/fuel ratio) the ECU is trying to maintain. This will vary depending on the engine speed and load.

Fuel Learn State – This indicates the state of the JACKPOT™ “Self-Tuning” operation (Learn Status). The system will automatically self-tune as you drive. There are several conditions that must be met for the Self-Tuning feature to occur. The engine temperature must exceed 160° F, the system must be operating in a Closed Loop mode, and Self-Tuning must be enabled. The base JACKPOT™ calibrations have the Self-Tuning feature enabled. Once the engine reaches 160° F, Self-Tuning should be active.

NOTE: If any of these parameters are not displaying a proper value, troubleshoot before further operation.

13.0 IDLE SETTING

Once the engine is at operating temperature, the idle speed can be set as desired.

Select the Tuning tab. Find the target hot idle speed. Move the button left and right to adjust it. Click the button to save the new value or select CANCEL at the bottom to move out of this screen.

Whether you change the target idle or not, you need to set the throttle plates on the throttle body to an optimal position. To do so, with the engine running, select the Monitor tab. You will see the Idle screen. Look at the “IAC Position” value. This value should be set between 6 and 20 with the engine in neutral and at operating temperature. Also make sure the “TPS” displays 0. If it is not, you need to perform the TPS Zero Learn procedure.

If the “IAC Position” value shows 0, you must close the throttle plates by adjusting the throttle plate position until it reads a value of 6-20. Slowly turn the throttle plate adjustment screw on the throttle body counterclockwise. If the IAC position is “stuck” at 0, it is likely the engine is idling at a higher speed than you have set the target idle speed for. You need to adjust the throttle plates to resolve this issue.

If the "IAC Position" value is greater than 20, open the throttle plates (turn the throttle shaft adjustment screw in, clockwise) until the "IAC Position" value is between 6 and 20. Note that if you open the throttle plates such that the "TPS" position goes above a value of 0, you will need to shut the vehicle off and perform TPS Zero Learn process.

Then restart the vehicle and continue adjusting the throttle plates. Once the TPS goes above a value of 0, the ECU goes out of its "idle" mode and will lock the IAC Position to a fixed value.

When the adjustments are completed, make sure the TPS reads a value of 0 with the engine idling.

14.0 SELF-TUNING

It is time to drive the vehicle and let the system perform the self-tuning process. The best way to self-tune is to drive the vehicle under as many different operating conditions as possible—different engine speeds and loads. Start by slowly revving the engine in neutral and holding it at different speeds, up to 2,500 RPM. This will help the system learn these points. Then drive the vehicle, using different transmission gears, when possible, to learn in different areas. If you have an automatic transmission, you may want to put it in gear, and with your foot on the brake pedal, apply a SMALL amount of throttle so that the system learns in this area as well.

NOTE: There are several conditions where Learning will NOT occur. They are the following:

- If the engine is below 160° F
- When the engine detects quick accelerator pedal movement
- At certain times when the accelerator pedal is lifted, and the vehicle is coasting
- If learning is disabled by the user

If you are interested in seeing if Self-Tuning is completed in a certain area, you can look at the following:

Select Monitor from the Main Menu then select Monitors

Select the Fuel Inj FW icon

The Fuel Learn1 State and Fuel Learn2 State indicate if the learn feature is active.

At this point you can drive and enjoy your JACKPOT™ EFI as it is.

DIAGNOSTIC LEDS

LED#	Function	Color	Definition
1	Power Indicator	Red	System power indicator
2	Engine Running Indicator	Blue	Engine running indicator, Blinking becomes faster with speed
3	Main Relay Indicator	Red	The main relay indicator, the ignition key is turned on, the main relay is turned on, and the key is turned off, the main relay is turned off after the system saves the learning data etc.
4	Fuel Pump Indicator	Blue	Fuel pump relay working indicator



TUNING REFERENCE MANUAL

1.0 System Setting

1.1 Number of Cylinders

This parameter is a part of the ECU calculation to determine the amount of fuel to inject. Enter the number of cylinders the engine has. This must be entered correctly, or the engine will not run correctly, if at all in some cases.

1.2 Engine Displacement

This parameter is a part of the ECU calculation to determine the amount of fuel to inject when running. Enter the engines displacement in cubic inches. This must be entered correctly, or the engine will run richer or leaner than intended.

1.3 Injector Flowrate

This parameter is a part of the ECU's calculation to determine the amount of fuel to inject when running. It is also used for fuel flow and mileage calculations. Enter the flow rate of the injectors in lbs./hr. This must be entered correctly, or the engine will run richer or leaner than intended. Keep in mind that fuel pressure affects flow rate. When manufacturers rate injectors, it is at a certain fuel pressure. Injectors from ACES are rated at 58 psi. Increased fuel pressure will cause a rich condition, lower fuel pressure will cause a lean condition.

1.4 Firing Oder

Jackpot™ EFI systems employ one coil on each spark plug and is the most reliable system used. Each coil fires sequentially in the cylinder firing order. The firing order must be corrected for your engine, if not, this will cause engine operation problems, plug the connector of ignition coil and injector harness of Jackpot™ harness into each of bank injectors and coils, make sure these are plugged in correctly. If they aren't, the firing order will not occur properly, and damage could result.

The Default setting firing order is LS engine 1-8-7-2-6-5-4-3.

1.5 Hot Idle Speed

Set idle speed of warm engine.

1.6 TPS Closed Threshold

This number is the threshold of TPS closed.

1.7 TPS Closed Hysteresis

This number is the hysteresis during TPS closed, bigger than Closed threshold.

1.8 Fan control

Fan1 On ECT--195° F

Fan2 On ECT--205° F

Fan1 Off ECT--180° F

Fan2 Off ECT--190° F

Fan1 On Delay Time

Fan2 On Delay Time

The ECU has an output to operate a cooling fan. This output switches to ground and is wired to the negative terminal of a relay to activate the fan. This parameter defines the coolant temperature that must be exceeded to activate the fan. It needs to be set higher than Fan Off Temperature (*F).

Delay time is how long time ECU turn on fan when the conditions are met.

1.9 Knock Sensor Numbers

Earlier model LS engines will have a knock sensor located in the center valley of the engine; the knock sensor number is 1. Later model LS engines have knock sensors located on the bottom of the block near the oil pan rails, the knock number is 2. Knock Sensors are not enabled in Jackpot™ ECU base calibrations but may be configured by using ACES Tuning software.

1.10 Knock Frequency

Knock center frequency is the sound that the sensor is looking to pick up.

1.11 Knock Detect Max/Min Speed

This RPM rang is knock detect window.

1.12 Knock Detect Min MAP

Knock detection will be enabled higher than this value.

1.13 Crankshaft Type

Engine reluctor wheel, option is 24x or 58x, select it for your engine configuration.

1.14 Dual WBOS

Jackpot™ ECU has dual lambda controller, each bank exhaust has one wide band O2 sensor, it is very important to make sure injector connector connected properly into each cylinder injector. Follow Jackpot™ wire harness installation carefully to install all the units.

Default setting is dual WBOS, dual wide band O2 sensor.

1.15 Drive By wire

The option is yes or no to configure your engine if has DBW throttle body.

1.16 Transmission Control

This option is to enable automatic transmission control, if your car has an electronically controlled auto transmission, select yes.

1.17 Transmission type

Jackpot™ ECU support to control GM4L60/65E,4L80/85E transmission.

1.18 Force TPS Zero Learn

Throttle Zero Position is an auto-learn strategy in Jackpot™ ECU, choose yes to do TPS Zero Learn again.

1.19 Key Off Clear Learn Data

Choose yes, then turn the ignition key to the off position, wait 5 seconds, then turn the key to the on position. All the Learn data (fuel learn table, IAC learn steps, ETC learn steps etc.) will be cleared.

2.0 SENSOR

2.1 MAP calibration

The MAP sensor sends a varying 0-5V signal to the ECU based on the vacuum/pressure the sensor is exposed to. The MAP Calibration table tells the ECU how to relate the voltage level with vacuum/pressure. MAP sensors typically have linear

calibrations.

ACES Jackpot™ EFI system include a 3bar TMAP sensor, the default setting of MAP sensor is ACES TMAP sensor AE1032, MAP sensor calibration type allows you change custom MAP sensor, edit the value of pressure vs different voltage. Information on MAP sensor calibration should be available from the sensor's manufacturer.

Our latest version of PC tuning software have a Map calculator

Type the value of pressure vs different voltage into calculator, then calculate the Coef A and Coef B.

MAP Linearity Coef A : 932

MAP Linearity CoefB: 79714

Make sure the **MAP Sensor Type** selected **Custom Coef A,B**

OPS Linearity Coef A

OPS Linearity Coef B

Oil pressure sensor calibration

FPS Linearity Coef A

FPS Linearity Coef B

Fuel pressure sensor calibration

Oil Pressure Calibration Type

Select the calibration type Coef AB or 1D table

Fuel Pressure Calibration Type

Select the calibration type Coef AB or 1D table

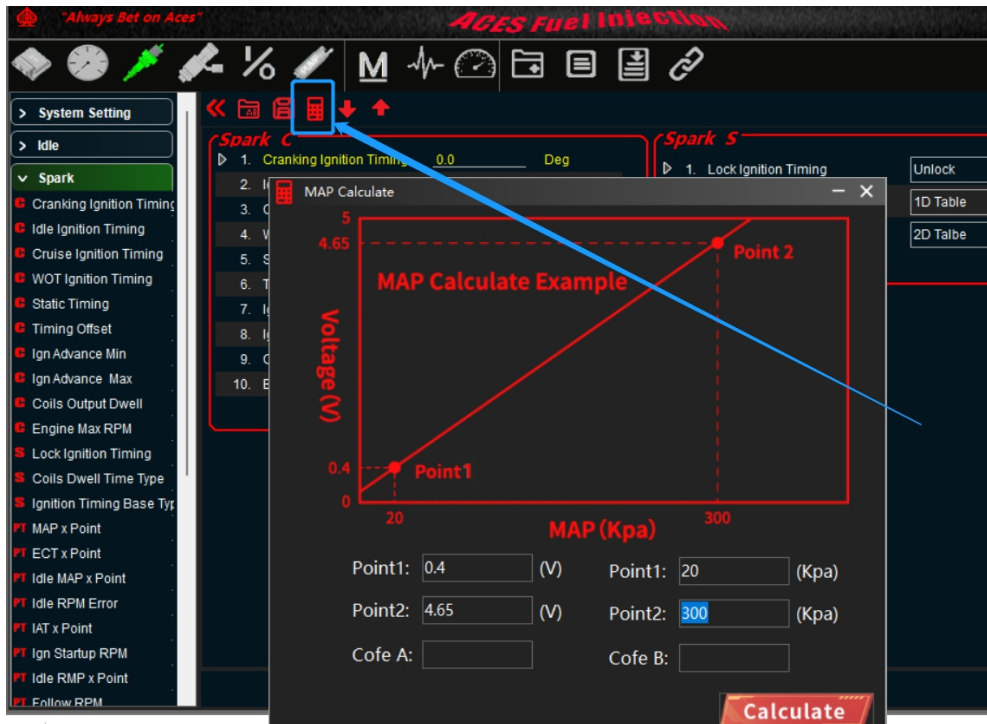

MAP Calculator

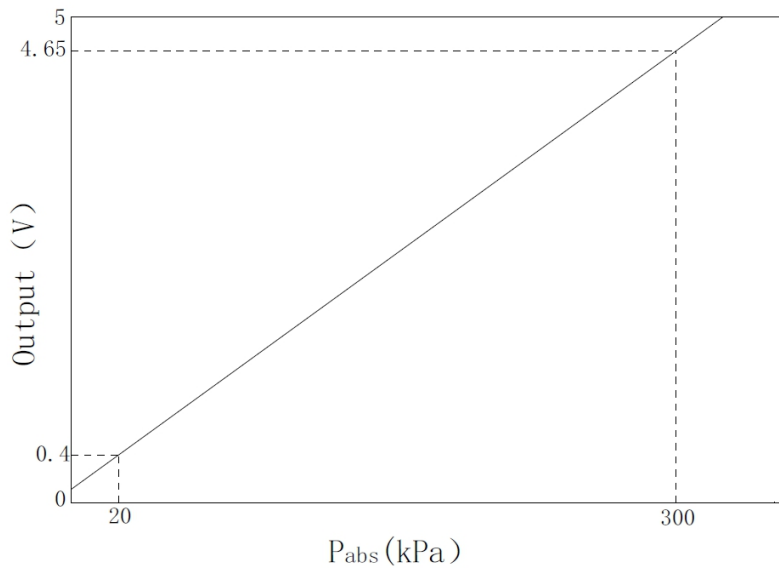

Map sensor Voltage Chart

2.2 Other Pressure sensor calibration

The calibration method of Engine oil pressure sensor and Fuel pressure sensor are same as MAP sensor.

2.3 Temperature Sensors calibration

There are several methods for calibrating temperature sensors for automotive systems. The most used method is the Comparison Method which utilizes two sensors: one of unknown quality (the sensor of interest) and one of reference or standard quality. Both sensors are subject to the same temperature environment and the temperature is cycled over the range of interest. The sensor calibration curve is modified during the controlled temperature sweep so the displayed temperature from the unknown sensor is the same as that of the reference sensor.

2.4 Coolant Temperature sensors (CTS) calibration

The default calibration of coolant temperature sensor is LSx sensor. To change the CTS sensor, edit the value of resistance vs different temperature. Information on CTS sensor calibration should be available from the sensor's manufacturer.

2.5 Manifold Intake Air Temperature sensors (IAT/MAT) calibration

The default calibration of IAT is LSx sensor. To change the IAT sensor, edit the value of resistance vs different temperature. Information on IAT sensor calibration should be available from the sensor's manufacturer.

2.6 TPS setting

IAC TPS Calc Max

Drive by cable throttle body sensor calculation AD Max value

IAC TPS Default Zero

Drive by cable throttle body closed AD value

IAC TPS Zero Window Size

The AD value of window size at TPS closed

ETB TPS Calc Max

Drive by wire throttle body sensor calculation AD Max value

ETB TPS Default Zero

Drive by wire throttle body closed AD value

ETB TPS Zero Window Size

The AD value of window size at TPS closed

3.0 IDLE

The goal of the engine operating states is to define the state of the engine related to its operating point. This state depends basically on engine speed and load. The following states are defined here: **engine stopped, startup, idle, push, WOT, push fuel cutoff, follow**. **Follow** is an engine operating state to make engine get to idle smoothly

3.1 Basic Idle Parameter

Follow Above Idle Min RPM

Min threshold RPM to get into follow states

Push Above Idle Min RPM

Min threshold RPM to get into push states

Push Above Idle Max RPM

Max threshold RPM to get into push states

Idle IAC Min Step

The minimum of IAC steps

Push Air Increase Ratio

This Value is Air (IAC motor steps) increase ratio during throttle body open process, bigger number is increasing fast.

Push Air Decay Ratio

This Value is Air (IAC motor steps) decrease ratio during throttle body close process

Follow Air Decay Ratio

This Value is Air (IAC motor steps) decrease ratio once engine is at Follow state, bigger number is decreasing fast to get idle target quickly, but too fast, engine is easy to shut down, smaller number will cause engine stuck at Follow state with high RPM long time

ETB Air Decay Adjust

The adjustment for air decay of Drive by wire throttle body

ETB Max Bypass Air

Max TPS of drive by wire throttle body at key on.

ETB Park Air vs ECT

This is the % position the drive by wire throttle body motor will be at during cranking and immediately after the engine starts. If it is too high, the engine RPM speed will be at too high once it starts - too low and poor starting will result. Note that this is a temperature-based table. The percentage value changed in the handheld offsets this entire curve.

IAC Park Air vs ECT

This is the % position the IAC motor will be at during cranking and immediately after the engine starts. If it is too high, the engine RPM speed will be too high once it starts - too low and poor starting will result. Note that this is a temperature-based table. The percentage value changed in the handheld offsets this entire curve.

Speed Rise Air

This is the % position of IAC or TPS % of DBW for adjusting peak RPM after engine startup

Idle Target Speed

The Idle Target Base table is used to set the desired engine idle speed vs coolant temperature. Typically, slightly higher target values are used at colder engine temperatures.

IAC Main P

Current idle speed is higher than target idle speed, the setting of proportion.

IAC Main I

Current idle speed is higher than target idle speed, the setting of integrate.

IAC Low Side P

Current idle speed is lower than target idle speed, the setting of proportion.

IAC Low Side I

Current idle speed is lower than target idle speed, the setting of integrate.

Idle Blanking windows Pos -- At engine idle state, when current idle speed is greater than the target idle speed, the difference between the current speed and target idle speed is less than this value, and the IAC closed-loop control is not performed. This parameter is a positive value.

Idle Blanking windows Neg -- At engine idle state, when current idle speed is less than the target idle speed, the difference between the current speed and target idle speed is less than this value, and the IAC closed-loop control is not performed. This parameter is a positive value.

3.2 Startup Air

Startup Air Fast Decay Cycle -- After the engine is started, the starting air quickly decays to the target idle speed according to a certain period. The smaller the value, the faster the air decays.

Startup Air Slow Decay cycle -- After the engine is started, the starting air quickly decays to the target idle speed in a certain period. When the actual speed is close to the target idle speed, the air decay speed should be slowed down. The larger the value, the slower the air decay.

After Start Air Decay Type -- If you select this option, the speed of starting air attenuation is determined by the 1D table, and the attenuation speed is determined by the ECT look-up table.

Park Air vs ECT

This is the % position the IAC motor will be at during cranking and immediately after the engine starts. If it is too high, the engine will be at too high of an RPM once it starts - too low and poor starting will result. Note that this is a temperature-based table. The percentage value changed in the handheld offsets this entire curve.

Speed Raise Air

This is the % position of IAC for adjusting peak RPM after engine startup.

Startup Air Fast Decay Cycle

1D table for Startup Air is decaying fast to get to target idle speed.

Startup Air Slow Decay Cycle

1D table for Startup Air is decaying slow to get to target idle speed.

4.0 SPARK

4.1 Basic Spark Parameter

Ign Advance Min

Min threshold of ignition advance

Ign Advance Max

Max threshold of ignition advance

Engine Max RPM

Max RPM of engine, Rev limiter is spark control.

Nitrous On Retard

This is the maximum amount of timing retard allowed if the Nitrous is activated.

Nitrous Retard Ramp Time

Nitrous is effective, the transition time of ignition advance delays smoothly from 0 to the target value, the larger value, the slower transition.

Launch Retard Ramp Time

When Launch control is activated, this value determines the time of launch on retard decays to 0.

Launch On Retard

This is the maximum amount of timing retard allowed if the Launch is activated.

Gear Upshift 1->2 Retard

This is the maximum amount of timing retard allowed if Gear upshift 1->2.

Gear Upshift 2->3 Retard

This is the maximum amount of timing retard allowed if Gear upshift 2->3.

Gear Upshift 3->4 Retard

This is the maximum amount of timing retard allowed if Gear upshift 3->4

Gear Downshift 4->3 Retard

This is the maximum amount of timing retard allowed if Gear Downshift 4->3

Gear Downshift 3->2 Retard

This is the maximum amount of timing retard allowed if Gear Downshift 3->2

Gear Downshift 2->1 Retard

This is the maximum amount of timing retard allowed if Gear Downshift 2->1

4.2 Knock Parameter

Knock Detect enable.

This option is knock detect function enable or disable.

Knock Sensor Numbers

There are 2 knock sensors for your V8 engine, default setting is 2.

Knock Detect Max speed.

Max threshold of engine speed for Knock Detect

Knock Detect Min Speed

Min threshold of engine speed for Knock Detect

Knock Detect Min MAP

Max threshold of MAP for Knock Detect

Knock Frequence

This frequency is dependent primarily on cylinder bore diameter, combustion pressure and temperature.

4.3 Rev limiter Type

There are 3 type rev limiters to choose:

***Cut Fuel** – Cut fuel flow only when the Engine Max RPM is hit. means that fuel will be removed from individual cylinders as needed to limit RPM.

Cut ignition – Cut ignition only when the Engine Max RPM is hit. Means that ignition will be removed from individual cylinders as needed to limit RPM.

***Cut Ign & Fuel** – Cut ignition and fuel when the Engine Max RPM is hit. Means that ignition and fuel will be removed from individual cylinders as needed to limit RPM.

*The strategy of fuel and ignition cut is individual cylinders control, it performs engine stable and smooth at Max rpm, Launch RPM, Burn RPM status.

4.4 Spark Correction

Idle RPM Fast Adjust

The ECU modifies commanded timing at idle to help maintain the target idle speed. This is a 2D graph used to vary ignition timing to help regulate idle speed. The horizontal axis of the graph represents the difference between the actual idle speed and the target idle speed, and the vertical axis of the graph represents the number of degrees to alter the ignition timing. If the idle speed is too high, the ECU will retard the timing by the amount specified in the graph. If the idle speed is too low, the ECU will advance the timing by the amount specified in the graph. It is recommended to set this entire table to zero as a starting point. Add timing trim only if you are otherwise unable to achieve a smooth, stable idle.

IAT Adjust

The IAT Adjust table is used to trim the ignition timing vs inlet air temperature. Often used on boosted applications as a safety mode. Ignition timing is reduced at very high air temperature readings to avoid detonation. Note that the trim values in this table are added (positive values) or subtracted (negative values) from the base ignition timing.

Idle ECT Adjust

The Idle ECT Adjust is used to trim the ignition timing vs coolant temperature at idle. Sometimes used on N/A applications with very large camshafts to help with warmup. A few degrees of additional timing during warmup can help quite a bit. Note that the trim values in this table are added (positive values) or subtracted (negative values) from the base ignition timing.

Boost Retard

This is Boost Retard table is used to retard the ignition time vs Boost pressure.

Launch Retard Enable

This feature will be activated when the launch button is applied. It is programmable from 0° - 20° in 1° increments. The Launch retard is used to offset the ignition timing during the 8 seconds after the launch button is released. It can optimize traction immediately after launch.

N2O Retard Enable

The High Roller CDI system can be configured to automatically retard timing when a Nitrous Oxide System is utilized. When the Nitrous is activated and the throttle position indicates wide open throttle the High Roller CDI can be programmed to remove timing from the overall timing that is set, this is configured with the handheld programmer.

Gear Shift Retard Enable

Timing retard is enable during Gear shift

Advance Coef

This Coef is timing gradient ramping rate between different ignition tables, the smaller value, the slower ramp.

Cranking Timing

Crank ignition advance is normally set to 15 for most engines to help quick start.

Idle Timing

10-30 degrees is typically used at idle but depends on configuration, camshaft, and engine displacement, etc.

Cruise Timing

25-40 degrees is typically used when cruising for optimal fuel economy.

WOT Timing

LS V8 engines are usually between 25-35 degrees.

4.5 Base Spark

MBT Timing

The MBT Timing is the main ignition table in the calibration. The MBT Timing Table is a 3D table used for setting ignition timing throughout the operating range of your engine. The first step in calibrating the MBT Timing table is to use the table below to fill in your timing values. This table gives you a general idea of during starting, idle, cruise, transition or high load, and deceleration. These values will get you in a safe area to start the tuning process.

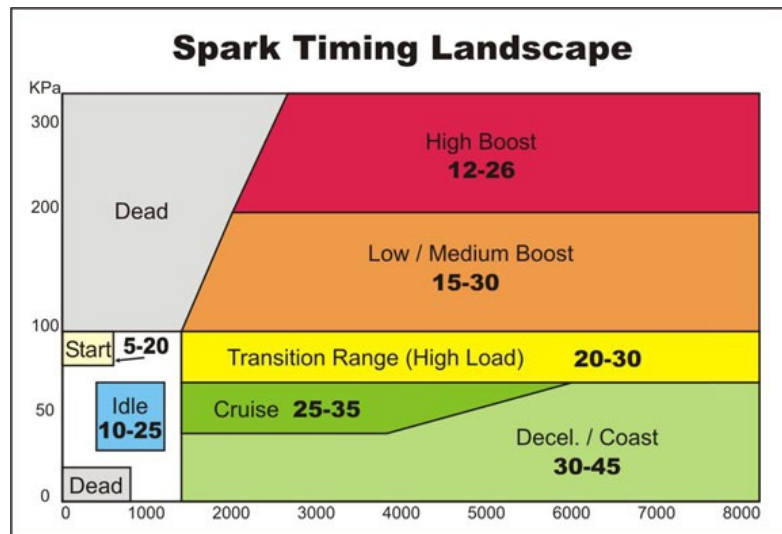

Startup Base Timing

The startup base timing is 3D table used for helping engine startup quickly.

Idle Base Timing

The Idle Base Timing is 3D table used for setting ignition timing vs RPM and MAP at idle, in order to get a good idle performance with different idle target and load.

Follow Base Timing

The follow base timing is 3D table used for setting ignition timing vs RPM and MAP at Follow of engine operating states. This table will be enabled during throttle body closed; it makes transition smoother when push, Push fuel cut off, and engine states go to idle.

5.0 FUEL

5.1 Basic Fuel Parameter

Clear Flood TPS

If the TPS value is at 65 or higher during cranking, the ECU will operate in "clear flood" mode, meaning that it will trigger the ignition but will not fire the injectors.

Fuel Prime Percent

This value is multiplying fuel PW of first injection during engine cranking.

Rated Injector Pressure

This value is injector working pressure, Fuel pressure of ACES fuel injector is 58PSI.

After Start Decay Cycle

After engine startup, engine rpm will get to idle from peak RPM. During this period, start air will decay. A smaller number of decay cycle will cause a faster rate of decay—engine goes to idle faster.

After Start Decay Rate

After engine startup, engine rpm will get to idle from peak RPM. During this period, start air will decay. A larger number of decay rate will cause a faster rate of decay—engine goes to idle faster.

5.2 Target AFR Setting

Idle AFR

Target AFR of fuel control when the engine is at Idle, typically between 13.5 and 15.0. Engines with larger cams may need a richer setting for smoothest idle.

Cruise AFR

Target AFR of fuel control when the engine is at Cruise, typically between 13.5 and 15.0. Engines with larger cams may need a richer AFR.

WOT AFR

Target AFR of fuel control when the engine is at Wot, typically between 12.5 and 13.2 on naturally aspirated engines (lower on power-adder combinations). Running richer may reduce power. Running leaner may reduce power or cause potential engine damage.

5.3 Individual Cylinder Fuel Correction

Cylinder 1-8 Correction

Fuel correction of each cylinder is multiplying fuel PW. The Simple option is a value multiplying fuel PW for each cylinder at whole engine operation. Another option is 3D table for setting fuel percent vs MAP and RPM. This table should be adjusted on the engine dyno or chassis dyno, it is better to have a lambda meter installed into each exhaust runner to monitor lambda.

5.4 Fuel Advanced Setting

Fuel Loop

This option is to enable or disable fuel loop control. Default setting is enabled fuel loop control. There is typically no reason to turn off closed loop operation unless you suspect an oxygen sensor problem and want to disable the sensor.

Fuel Learn

This option is to enable or disable fuel learn control, default setting is enabled fuel learn control. If enabled, self-tuning is performed. Learning should be enabled when an engine is first run with the Jackpot™ and the tuning process is occurring.

Target AFR type

The simple option is a value at different engine state, The Target AFR Table is a 2D table used for setting target air/fuel ratios throughout the operating range of the engine.

Fuel Correction Type

The Simple option is a value multiplying fuel PW for each cylinder at whole engine operation. Another option is 2D table for setting fuel percent vs MAP and RPM.

Fuel Pressure Sensor Used

Fuel pressure sensor default setting is NO in Jackpot™ EFI system.

5.5 Fuel Correction and Compensation

Min Fuel PW

Injector close time.

Injector Off Time

Injector opening time vs different battery voltage.

MAT Fuel Enrichment

The Manifold Air Temp Enrichment table is used to compensate for air density changes with inlet air temperature. It can also be used in a safety mode to add additional cooling fuel at very high inlet air temperatures on boosted applications.

ECT Fuel Enrichment

This table is displayed as a 3D graph of after start fuel enrichment, based on coolant temperature and MAP. This feature allows adding more fuel to get engine warmup quickly. The higher you set these values, the longer it would take after start fueling to

begin once the engine is started.

5.6 Startup Fuel

Cranking Fuel

This table mainly affects cold start-up. It is displayed as a 2D graph of injector pulse width during cranking based on engine coolant temperature vs RPM or Rev. At normal operating temperature, this graph is typically set to deliver 40-50% more fuel than is used at an idle. The colder the engine is, the more cranking fuel it will require for easy starting. If your engine seems to crank for a long time before it fires, try increasing the pulse width; if the engine produces black smoke or seems to “load up” when it fires, try reducing the pulse width.

After Start Enrichment

After start enrichment is helpful for providing additional fuel right after initial startup to help a cold motor stay running, and it helps prevent a heat-soaked motor from surging on startup as well, acting as somewhat of a “choke” function. This table is displayed as a 3D graph of fuel enrichment applied after the engine is started based on engine coolant temperature and engine revolution. This enrichment will be applied after the ECU enters “run” mode. This fuel enrichment will decay out as the number of engine revolutions increases.

After Start Decay Rate

This table is displayed as a 2D graph of the rate at which the after-start enrichment will decay out based on engine temperature. The decay rate is shown as the number of crank pulses that must be received by the ECU to reduce the after-start enrichment. The higher you set these values, the longer it would take for the after-start fuel to decay out once it was applied.

5.7 Acceleration/Deceleration Fueling

When the throttle is rapidly opened or closed the demand for fuel increases or decreases. If at a low-throttle-angle, steady-state running condition the throttle is opened rapidly, manifold pressure increases. In this situation, the sudden demand for air (hence power) requires a temporary enrichment of the mixture to maintain a reasonable AFR. Because the rapid opening of the throttle is consistent with the need for high-power AFR during acceleration, it is equivalent to the value needed for full power.

The amount of enrichment required is largely dependent on the design of the inlet tract and placement of the injectors. Enrichment for systems where the injectors are placed far from the inlet valves will have to be higher than if the injectors are placed near the inlet valves. This is because when the injectors are far from the inlet valves, such as on throttle body systems, there is considerable manifold wall wetting.

At low manifold pressures (commonly high manifold vacuum), fuel tends to stay in the air stream in a vapor-like state and has relatively low wetting characteristics. The reason the wetting is lower at high vacuum is because the pressure in the inlet manifold is closer to the vapor pressure of the fuel, allowing the fuel to evaporate more readily (This is the same phenomenon that makes water boil at a lower temperature at higher altitudes than at sea level).

As the throttle opens, manifold pressure increases (vacuum decreases), which increases the pressure on the fuel vapor driving it to a more liquid state. This causes droplets of fuel to deposit on the manifold walls and come out of the air stream. When the air speed in the inlet manifold increases to a point where the liquid fuel on the manifold walls is reintroduced into the air stream, there is no need for additional fueling and acceleration fuel is shut off.

With most modern road cars, the injectors are placed near the inlet valves so that manifold wall wetting is virtually eliminated. With the elimination of wetting comes the drastic reduction of acceleration fuel requirement. This configuration of fuel injector needs short duration and a small amount of fuel for acceleration enrichment.

The prime input for acceleration data for the ECU is the throttle position sensor (TPS). The TPS indicates the rate of change of the throttle plate to the ECU so that it can calculate the amount of fuel in both volume (additional pulse width) and time (duration of additional pulse width). Very rapid throttle movements usually require a short duration of a large amount of fuel, while slow throttle changes use minimal amounts of additional fuel over a longer period.

When the throttle is closed rapidly the need for fuel is reduced sharply. Under deceleration manifold pressure is very low (high vacuum). Any fuel that was on the manifold walls, port walls, or valve head is re-introduced into the air stream due to the rapid decrease in manifold pressure resulting in a temporarily rich mixture. The main fuel MAP values are usually very low when experiencing low manifold pressure, so minimal fuel is being injected into the engine. However, the mixture will still be rich due to the re-vaporization of the wetted fuel.

Acceleration Enrichment vs TPS

Ads additional, momentary fuel based on the rate of change of the TPS. Same function as an accelerator pump on a carburetor.

TPS Acceleration Enrichment vs ECT

Displays a 2D graph of acceleration enrichment fuel applied in ECT change. This 2D graph is increasing or decreasing the 3D table of TPS base film which is activated to running at engine state of acceleration and deceleration.

MAP Acceleration Enrichment vs ECT

Displays a 2D graph of acceleration enrichment fuel applied in ECT change. This 2D graph is increasing or decreasing the 3D table of MAP base film which is activated to running at engine state of acceleration and deceleration.

TPS Acceleration Decay Rate

Displays a 2D graph of TPS acceleration enrichment fuel decay rate applied in ECT change.

MAP Acceleration Decay Rate

Displays a 2D graph of MAP acceleration enrichment fuel decay rate applied in ECT change.

Acceleration Correction vs TPS

Displays a 2D graph of TPS acceleration enrichment fuel.

TPS Acceleration Enrich vs ECT

Displays a 2D graph of acceleration enrichment fuel applied in ECT change. This 2D graph is increasing or decreasing the 3D table of TPS base film which is activated to running at engine state of acceleration and deceleration.

MAP Acceleration Enrich vs ECT

Displays a 2D graph of acceleration enrichment fuel applied in ECT change. This 2D graph is increasing or decreasing the 3D table of MAP base film which is activated to running at engine state of acceleration and deceleration.

5.8 Base Fuel MAP

Volumetric Efficiency

The Volumetric Efficiency table will appear as a 3D table of % VE values vs. intake manifold pressure in PSI and engine RPM. The table will be labeled "Volumetric Efficiency vs. RPM and MAP".

This table gives you a general idea of where the cursor will be during idle, cruise, transition or high load, and deceleration. These values will get you in a safe area to start the tuning process.

The Volumetric Efficiency table should be calibrated in one of two ways:

1. While operating in closed loop mode, adjust the values in each cell so that the INJ Loop % (which can be viewed below the table as part of the dashboard function) values are as small as possible while operating within that cell. See the Measure or Gauge section for more details. For example, if you are operating in a cell in the VE table with a value of 50 and you see that there is a 10% INJ Loop being applied, increase 10% correction to that cell value in the VE table. The result is that the cell that was reading 50 will now read 55, and the INJ Loop % will be very close to zero. Please bear in mind that this utility is meant to be used only in a "steady state" mode. You should also only use this utility when the floating cursor is centered within a single cell. If the cursor is being influenced by surrounding cells, if the engine speed or load is changing, or if any acceleration enrichment fuel is being applied, the results of using this will be well off from the intended result.
2. While operating in open loop mode, adjust the values in each cell so that the actual measured air/ fuel ratio (Actual A/F) matches the target air/fuel ratio (Target A/F) as closely as possible.

Target AFR

The Target AFT Table is a 3D table used for setting target air/fuel ratios throughout the operating range of the engine appearing as "Target Air/Fuel Ratio vs. RPM & MAP" .

There is a particular ratio of air to fuel that results in all the oxygen molecules combining chemically with all the fuel molecules. This ratio is 14.7:1, meaning 14.7 parts of air for every one part of fuel. Running an engine at this air/fuel ratio helps to minimize emissions and maximize fuel economy, but this air/ fuel ratio is generally not safe to run at high RPM and/or engine load

conditions. Since most oxygen sensors produced are only meant to accurately measure a 14.7:1 air/fuel ratio, they shouldn't be used in applications where much richer or leaner target air/fuel ratios are selected. The wide-band oxygen sensor used with this system is capable of accurately measuring a much wider range of air/fuel ratios. This system can measure any ratio from as rich as 9:1 to as lean as 16:1, thus allowing us to tune for more power and better fuel efficiency. The first step in calibrating the target air/fuel ratio table is to use the table below to fill in your table air/fuel ratio values. This table gives you a general idea of where the cursor will be during starting, idle, cruise, transition or high load, and deceleration. These values will get you in a safe area to start the tuning process.

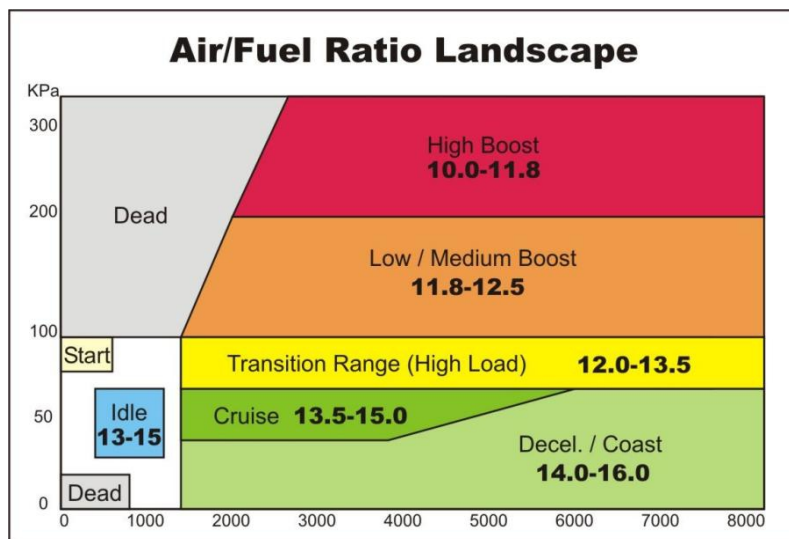

ECT AFR Offset

This table is displayed as a 3D graph of compensate AFR target based on coolant temperature and MAP. This feature allows an offset AFR target throughout engine operating range. Positive value increases the AFR target to lean side, negative value decrease to rich side.

Fuel Self Learn Table/2

The fuel self-learn control strategy is designed to compensate for variability in the fuel system components. If, during normal vehicle operation, the fuel system is detected to be biased, rich or lean, the fuel self-learn control will make a corresponding shift in the fuel delivery calculation. Learning should be enabled when an engine is first run with the Jackpot™ and the tuning process is occurring. After the vehicle is driven under various operating conditions, and is running well, this table will learn and adapt your engine setup and fuel.

FPS Type

FPS type allows you select different fuel pressure sensor.

FPS Fuel Inj Compe Enable

Fuel pressure compensation enable for fuel calculation.

OPS Type

OPS type allows you select different oil pressure sensor.

Fuel Learn Min ECT

The threshold of ECT is enable fuel learn

6.0 FUEL PUMP

6.1 Turn Off RPM

Engine rpm lower than setting numbers, fuel pump will turn off.

6.2 Key-On Pump Hold Time

The length of time the fuel pump will run when key-on power is present without engine cranking. This is primarily used for

priming the fuel system prior to starting the engine.

6.3 Turn Off After Lose RPM

The length of time that the fuel pump will run before shutting off after the ECU loses crank signal.

7.0 System IO

Fan1 On ECT--195° F

Fan2 On ECT--205° F

Fan1 Off ECT--180° F

Fan2 Off ECT--190° F

Fan1 On Delay Time

Fan2 On Delay Time

The ECU has an output to operate a cooling fan. This output switches to ground and is wired to the negative terminal of a relay to activate the fan. This parameter defines the coolant temperature that must be exceeded to activate the fan. It needs to be set higher than Fan Off Temperature (*F).

8.0 TRANSMISSION

8.1 Basic Setting

Transmission Type

Select your transmission type: 4L60/65E or 4L80/85E

Transmission Control

Transmission control enable or disable, chosen by YES or NO

Teeth For VSS Sensor

The teeth number of VSS sensor for calculation

Tire Diameter

The overall tire diameter. Example (234/65R15 tire size =27" tire diameter)

"Rear Gear Ratio

The final drive axle ratio of your car. Example (3:73, 4:10, 3:23)

VSS Correction

The Correction of vehicle speed, use a GPS instrument or Google Map on a smart phone, or other calibrated measurements to set this correctly.

4L60/5E Gear Ratio1

4L60/5E Gear Ratio2

4L60/5E Gear Ratio3

4L60/5E Gear Ratio4

The gear ratio of your 4L60/5E transmission.

4L80/5E Gear Ratio1

4L80/5E Gear Ratio2

4L80/5E Gear Ratio3

4L80/5E Gear Ratio4

The gear ratio of your 4L80/5E transmission.

8.2 TCC Setting

Contains parameters that tune TCC activation and deactivation.

THE TCC WILL NOT APPLY UNTIL THE ENGINE IS ABOVE 122°F, AS WELL AS A TRANSMISSION FLUID TEMPERATURE ABOVE 46°F.

TCC Disable

This will disable TCC functionality in all conditions.

Unlock TCC During Upshift

Unlock TCC During Downshift

Minimum Gear TCC Enable

This is the minimum Gear in which the Torque Converter Clutch will enable.

Minimum RPM TCC Enable

This is the minimum RPM at which the Torque Converter Clutch will enable. This value can be adjusted so that engines with large camshafts do not hesitate surge if the TCC is applied at too low of an engine speed.

Below RPM Disable TCC

Used to unlock the TCC once it is locked. The Lock and Unlock values should not be too close together, or they will continuously lock and unlock. Applications with high stall torque converters will typically need 400 -700 RPM or more between these values.

TCC Enable Maximum TPS

Throttle position value when the TCC unlocks. Most lockup torque converters do not have a clutch designed to lock up when higher power is being applied. It is best to unlock the converter under moderate to hard acceleration. Typically, TPS values should be between 25 -50%.

TCC Lock Ramp Time

When TCC Lock is active, the transition time (climbing time) of PWM duty cycle changes from small to large.

TCC Unlock Ramp Time

When TCC Unlock is active, the transition time (drop time) of PWM duty cycle changes from large to small.

TCC Lock Start Duty Cycle

PWM initial duty cycle of TCC starting lock.

TCC Lock End Duty Cycle

PWM duty cycle of TCC locked completely.

TCC Unlock Start Duty Cycle

PWM initial duty cycle of TCC starting to unlock.

TCC Unlock End Duty Cycle

PWM duty cycle of TCC unlocked completely.

TCC Lock Speed

This is a table to adjust when the TCC locks based upon throttle position and vehicle speed.

TCC Unlock Speed

This is a table to adjust when the TCC unlocks based upon throttle position and vehicle speed.

*These parameters work in addition to the TCC Parameters by offering additional tuning based on vehicle speed. This keeps the TCC from locking up during 'around-town' driving if it is not desired. The Lock values should always be higher than the Unlock values. Adjustments to these can be done by using the graph.

8.3 Shift Gear

Each Up-shift and Down-shift can be completely configured by selecting 'Shifts' from the transmission menu.

All Upshift points must occur at a higher speed than downshift. although it can be programmed with the handheld, the ECU won't allow a downshift to occur if it will over -rev the past the MAXIMUM RPM in the SYSTEM>TRANSMISSION>TRANS SETUP area.

Upshift 1st->2nd Speed

Table used to modify 1-2 upshift based on throttle position (or MAP for boosted applications) and speed.

Upshift 2nd->3rd Speed

Table used to modify 2-3 upshift based on throttle position (or MAP for boosted applications) and speed.

Upshift 3rd->4th Speed

Table used to modify 3-4 upshift based on throttle position (or MAP for boosted applications) and speed.

Downshift 2nd->1st Speed

Table used to modify 1-2 downshift based on throttle position (or MAP for boosted applications) and speed.

Downshift 3rd->2nd Speed

Table used to modify 3-2 downshift based on throttle position (or MAP for boosted applications) and speed.

Downshift 4th->3rd Speed

Table used to modify 4-3 downshift based on throttle position (or MAP for boosted applications) and speed.

WOT shift

1-2 WOT Upshift

This is the RPM at which the 1 -2 upshift will occur.

2-3 WOT Upshift

This is the RPM at which the 1 -2 upshift will occur.

3-4 WOT Upshift

This is the RPM at which the 1 -2 upshift will occur.

8.4 Line Pressure

Tune the line pressure vs. TPS or MAP for each gear. A lower duty cycle (moving towards 0%) increases line pressure with 0% providing maximum line pressure applied. Values above 40-50% typically result in a line pressure too low for any throttle position, which may result in transmission damage.

Naturally aspirated and nitrous calibrations created through the wizard use TPS for line pressure vs. load scaling, whereas turbo or supercharged calibrations use map sensor for line pressure vs load scaling.

Line Pressure 1st Gear

Editable line pressure curve for 1st gear.

Line Pressure 2nd Gear

Editable line pressure curve for 2nd gear.

Line Pressure 3rd Gear

Editable line pressure curve for 3rd gear

Line Pressure 4th Gear

Editable line pressure curve for 4th gear

Line Pressure ATF Correction

ATF correction of line pressure

9.0 Rev Limiter

Rev Limiter Type

Cut Ign&Fuel - Cut ignition and fuel when the Engine Max RPM is hit. Means that ignition and fuel will be removed from individual

cylinders as needed to limit RPM.

*The strategy of fuel and ignition cut is individual cylinder control, it ensures the engine performs stable and smooth at Max RPM, Launch RPM, Burn RPM status.

Engine Max Rev

The Max rpm of engine revolution

Launch Target Rev

The target rpm of launch control

Launch Released Drop Rev

This option is for Manual shift applications using the clutch switch between shifts. This value will set up an RPM window so the Launch RPM limit feature will not reactivate when using the clutch between shifts. This RPM must be set lower than Launch RPM.

High Roller Launch Rev setting example:

Launch Limit RPM: 3800

Launch Drop RPM: 1000

This example shows the car will launch at 3,800 rpm and will have to drop to 2800 (3800 - 1000) rpm during running to reset the launch feature.

HARNESS DRAWINGS - LS engine main harness

AH2011A/B

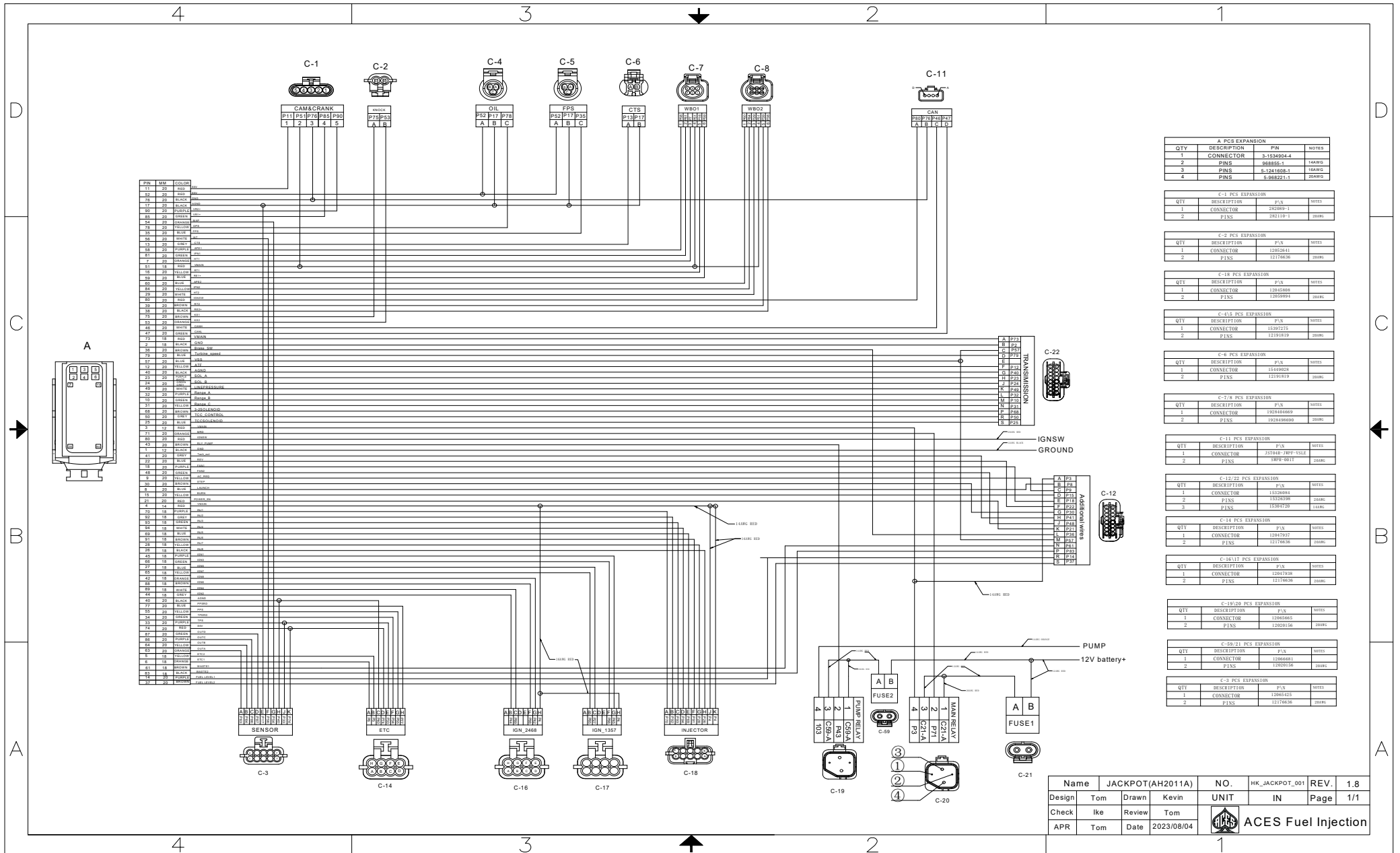

A PCS EXPANSION			
QTY	DESCRIPTION	P/N	NOTES
1	CONNECTOR	3-1534804-4	
2	PINS	968865-1	14AWG
3	PINS	6-1241608-1	16AWG
4	PINS	6-0682921-1	20AWG

C-1 PCS EXPANSION			
QTY	DESCRIPTION	P/N	NOTES
1	CONNECTOR	392809-1	
2	PINS	282110-1	20AWG

C-2 PCS EXPANSION			
QTY	DESCRIPTION	P/N	NOTES
1	CONNECTOR	120420-1	
2	PINS	12117600-0	20AWG

C-18 PCS EXPANSION			
QTY	DESCRIPTION	P/N	NOTES
1	CONNECTOR	13045800	
2	PINS	12005994	20AWG

C-4/5 PCS EXPANSION			
QTY	DESCRIPTION	P/N	NOTES
1	CONNECTOR	1030272	
2	PINS	12151910	20AWG

C-4 PCS EXPANSION			
QTY	DESCRIPTION	P/N	NOTES
1	CONNECTOR	12499000	
2	PINS	12151910	20AWG

C-7/8 PCS EXPANSION			
QTY	DESCRIPTION	P/N	NOTES
1	CONNECTOR	1925104659	
2	PINS	1925104690	20AWG

C-11 PCS EXPANSION			
QTY	DESCRIPTION	P/N	NOTES
1	CONNECTOR	215041-3PP-151E	
2	PINS	899-0011	20AWG

C-12/22 PCS EXPANSION			
QTY	DESCRIPTION	P/N	NOTES
1	CONNECTOR	15224891	
2	PINS	12005994	20AWG
3	PINS	15304120	14AWG

C-14 PCS EXPANSION			
QTY	DESCRIPTION	P/N	NOTES
1	CONNECTOR	12047937	
2	PINS	12117600-0	20AWG

C-6/17 PCS EXPANSION			
QTY	DESCRIPTION	P/N	NOTES
1	CONNECTOR	12047938	
2	PINS	12117600-0	20AWG

C-19/20 PCS EXPANSION			
QTY	DESCRIPTION	P/N	NOTES
1	CONNECTOR	12046865	
2	PINS	12020156	20AWG

C-59/21 PCS EXPANSION			
QTY	DESCRIPTION	P/N	NOTES
1	CONNECTOR	12046861	
2	PINS	12020156	20AWG

C-3 PCS EXPANSION			
QTY	DESCRIPTION	P/N	NOTES
1	CONNECTOR	12046825	
2	PINS	12117600-0	20AWG

Name	JACKPOT(AH2011A)	NO.	HK_JACKPOT_001	REV.	1.8
Design	Tom	Drawn	Kevin	UNIT	IN
Check	Ike	Review	Tom	Page	1/1
APR	Tom	Date	2023/08/04		

4

3

2

1

C-21 PCS EXPANSION					
PN	CIRCUIT FUNCTION	COLOR	CONNECTS TO	AWG	
A	BAT_IN	RED	C20-13	12	
B	12V battery(+12AWG)	RED		12	

C-20 PCS EXPANSION					
PN	CIRCUIT FUNCTION	COLOR	CONNECTS TO	AWG	
1	BAT_IN	RED	C21-A	20	
2	MFD	ORANGE	A-71	20	
3	BAT_IN	RED	C21-A	12	
4	VMAIN	RED	A-3	12	

C-19 PCS EXPANSION					
PN	CIRCUIT FUNCTION	COLOR	CONNECTS TO	AWG	
1	VMAIN	RED	C59-A	20	
2	RLY PUMP	BROWN	A-43	20	
3	VMAIN	RED	C59-A	14	
4	PUMP(14AWG)	ORANGE	103	14	

C-18 PCS EXPANSION					
A	VMAIN	RED	A-73	18	
B	GND	BLACK	A-2	18	
C	VBS	BLUE	A-67	20	
D	Turnip_sense	BLUE	A-79	20	
E					
F	ATP	YELLOW	A-12	20	
G	AGND	BLACK	A-40	20	
H	SOL_A	PURPLE/WHITE	A-23	20	
J	SOL_B	GRAY/GREEN	A-24	20	
K	LINER/PRESSURE	WHITE	A-40	20	
L	Range_A	PURPLE	A-10	20	
M	Range_B	GREEN	A-10	20	
N	Range_C	YELLOW	A-31	20	
P	3-2 SOLENOID	BROWN	A-68	20	
R	TCC_CONTROL	GRAY	A-50	20	
S	TCC_SOLENOID	BLUE	A-25	20	

C-18 PCS EXPANSION					
PN	CIRCUIT FUNCTION	COLOR	CONNECTS TO	AWG	
1	INJ1	PURPLE	A-10	18	
2	INJ2	GREY	A-92	18	
3	INJ3	GREEN	A-63	18	
4	INJ4	WHITE	A-94	18	
5	INJ5	BLUE	A-69	18	
6	INJ6	BROWN	A-61	18	
7	INJ7	YELLOW	A-28	18	
8	INJ8	BLACK	A-26	18	
9	VMAIN	RED	A-4	18	
10	VMAIN	RED	A-4	18	

C-1 PCS EXPANSION					
PN	CIRCUIT FUNCTION	COLOR	CONNECTS TO	AWG	
1	SSV1	RED	A-11	20	
2	VMAIN	BLACK	A-76	20	
3	GND	PURPLE	A-60	20	
2	VR1+	BLACK	A-76	20	
3	VR1+	PURPLE	A-90	20	

C-4 PCS EXPANSION					
PN	CIRCUIT FUNCTION	COLOR	CONNECTS TO	AWG	
1	AGND	BLACK	A-17	20	
2	SSV	RED	A-62	20	
3	OPB	YELLOW	A-78	20	

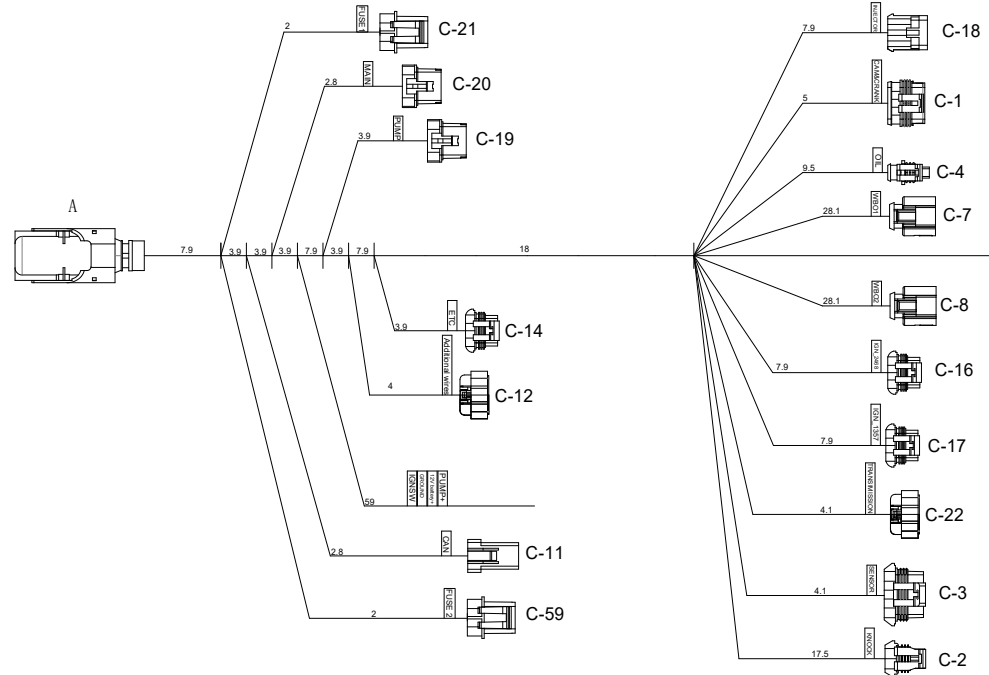

C-6 PCS EXPANSION					
PN	CIRCUIT FUNCTION	COLOR	CONNECTS TO	AWG	
1	SSV	RED	A-52	20	
2	AGND	BLACK	A-17	20	
3	PPS	BLUE	A-35	20	

C-6 PCS EXPANSION					
PN	CIRCUIT FUNCTION	COLOR	CONNECTS TO	AWG	
A	CTS	GRAY	A-13	20	
B	AGND	BLACK	A-17	20	

C-6 PCS EXPANSION					
PN	CIRCUIT FUNCTION	COLOR	CONNECTS TO	AWG	
A	CTS	GRAY	A-13	20	
B	AGND	BLACK	A-17	20	

C-18 PCS EXPANSION					
	CIRCUIT FUNCTION	COLOR	CONNECTS TO	AWG	
B	IGN2	GRAY	A-44	18	
C	IGN	WHITE	A-60	18	
E					
F	IGN6	BROWN	A-68	18	
G	IGN8	ORANGE	A-42	18	
H	VMAIN	RED	A-4	18	

C-3 PCS EXPANSION					
PN	CIRCUIT FUNCTION	COLOR	CONNECTS TO	AWG	
1	KS1	BROWN	A-75	20	
2	KS2	ORANGE	A-63	20	

C-17 PCS EXPANSION					
	CIRCUIT FUNCTION	COLOR	CONNECTS TO	AWG	
B	IGN7	YELLOW	A-65	18	
C	IGN5	BLUE	A-27	18	
E					
F	IGN3	GREEN	A-68	18	
G	IGN1	PURPLE	A-45	18	
H	VMAIN	RED	A-4	18	

C-3 PCS EXPANSION					
PN	CIRCUIT FUNCTION	COLOR	CONNECTS TO	AWG	
A	OUTA	ORANGE	A-60	20	
B	OUTB	YELLOW	A-64	20	
C	OUTC	PURPLE	A-66	20	
D	OUTD	GREEN	A-67	20	
E	AGND	BLACK	A-17	20	
F	RET	WHITE	A-56	20	
G	MAP	BLUE	A-54	20	
H	AGND	BLACK	A-40	20	
J	TPS	BROWN	A-33	20	
K	SSV	RED	A-74	20	

C-59 PCS EXPANSION					
PN	CIRCUIT FUNCTION	COLOR	CONNECTS TO	AWG	
A	BAT_IN	RED	C19-10	14	
B	12V battery(+12AWG)	RED		14	

C-14 PCS EXPANSION					
A	CIRCUIT FUNCTION	COLOR	CONNECTS TO	AWG	
A	ETC1	YELLOW	A-5	18	
B	ETC2	ORANGE	A-5	18	
C	AGND	BLACK	A-40	20	
D	SSV	RED	A-74	20	
E	TPS	PURPLE	A-33	20	
F	TPSD	GREEN	A-34	20	
G	PPS	YELLOW	A-55	20	
H	PPSD	BLUE	A-77	20	

C-12 PCS EXPANSION					
A	CIRCUIT FUNCTION	COLOR	CONNECTS TO	AWG	
A	VMAIN	RED	A-3	14	
B	LAUNCH	BLUE	A-6	20	
C	AC_REB	YELLOW	A-60	20	
D	SUNY	YELLOW	A-55	20	
E	FAN1	PURPLE	A-18	20	
F	REV	BLUE	A-32	20	
G	STEP	BROWN	A-30	20	
H	Tab_out	GRAY	A-41	20	
J	FAN2	GREEN	A-68	20	
K	POWER_EN	RED	A-21	20	
L	Brake SW	BROWN	A-38	20	
M	VBS	BLUE	A-67	20	
N	WASTE1	BROWN	A-61	18	
P	WASTE2	BLACK	A-63	18	
R	FUEL LEVEL 1	PURPLE	A-14	20	
S	FUEL LEVEL 2	BROWN	A-37	20	

C-11 PCS EXPANSION					
PN	CIRCUIT FUNCTION	COLOR	CONNECTS TO	AWG	
1	IGNW	RED	A-30	20	
2	GND	BLACK	A-78	20	
3	CANH	WHITE	A-46	20	
4	CANL	GREEN	A-47	20	

Name	JACKPOT(AH2011A)	NO.	HK_JACKPOT_002	REV.	1.8
Design	Tom	Drawn	Kevin	UNIT	IN
Check	Ike	Review	Tom	Page	1/1
APR	Tom	Date	2023/08/04	 ACES Fuel Injection	

4

3

2

1

Transmission Harness AH2011-1

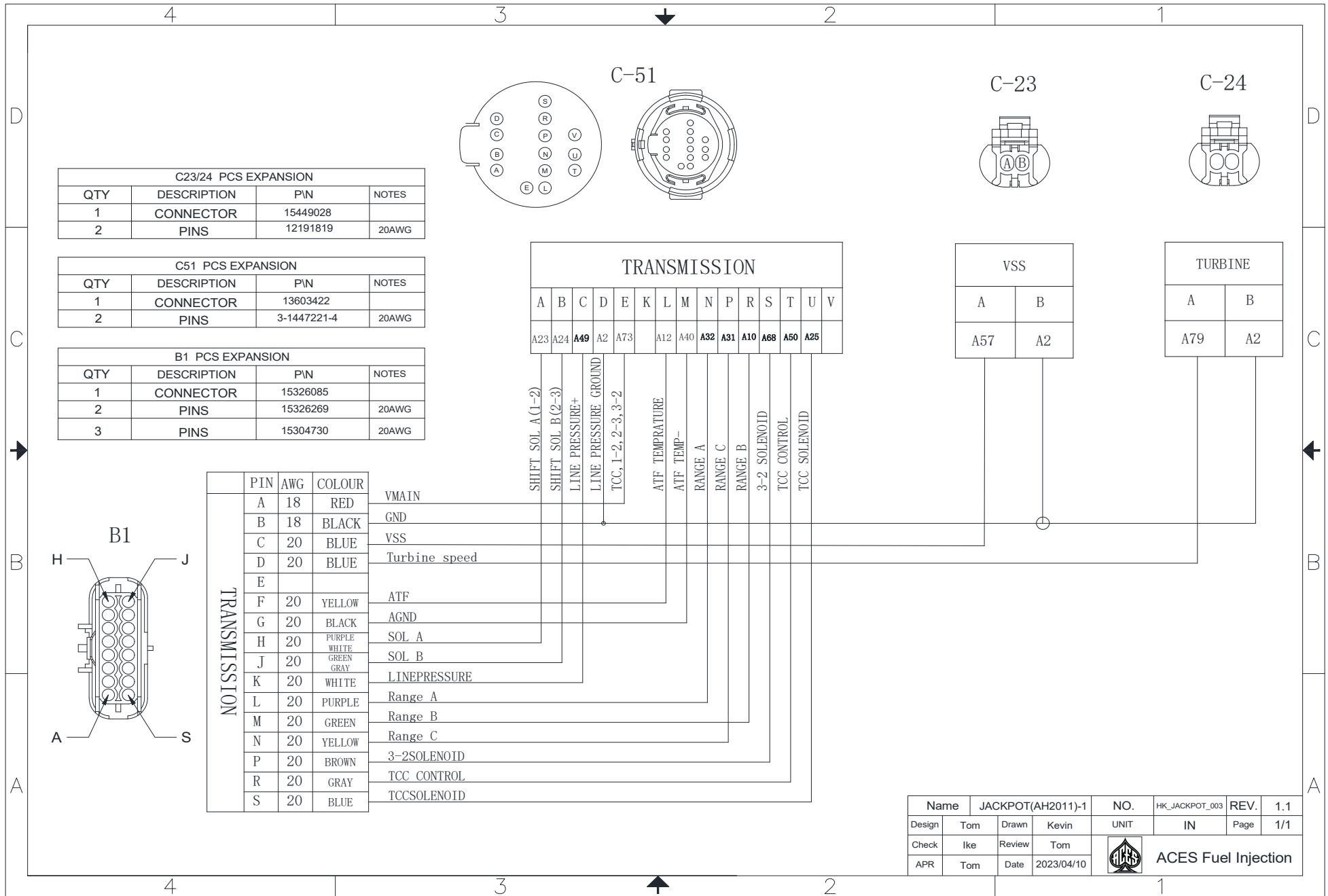

C23/24 PCS EXPANSION			
QTY	DESCRIPTION	PIN	NOTES
1	CONNECTOR	15449028	
2	PINS	12191819	20AWG

C51 PCS EXPANSION			
QTY	DESCRIPTION	PIN	NOTES
1	CONNECTOR	13603422	
2	PINS	3-1447221-4	20AWG

B1 PCS EXPANSION			
QTY	DESCRIPTION	PIN	NOTES
1	CONNECTOR	15326085	
2	PINS	15326269	20AWG
3	PINS	15304730	20AWG

PIN	AWG	COLOUR	FUNCTION
A	18	RED	VMMAIN
B	18	BLACK	GND
C	20	BLUE	VSS
D	20	BLUE	Turbine speed
E			
F	20	YELLOW	ATF
G	20	BLACK	AGND
H	20	PURPLE	SOL A
J	20	GREEN	SOL B
K	20	WHITE	LINEPRESSURE
L	20	PURPLE	Range A
M	20	GREEN	Range B
N	20	YELLOW	Range C
P	20	BROWN	3-2SOLENOID
R	20	GRAY	TCC CONTROL
S	20	BLUE	TCCSOLENOID

Name	JACKPOT(AH2011)-1	NO.	HK_JACKPOT_003	REV.	1.1
Design	Tom	Drawn	Kevin	UNIT	IN
Check	Ike	Review	Tom	Page	1/1
APR	Tom	Date	2023/04/10	 ACES Fuel Injection	

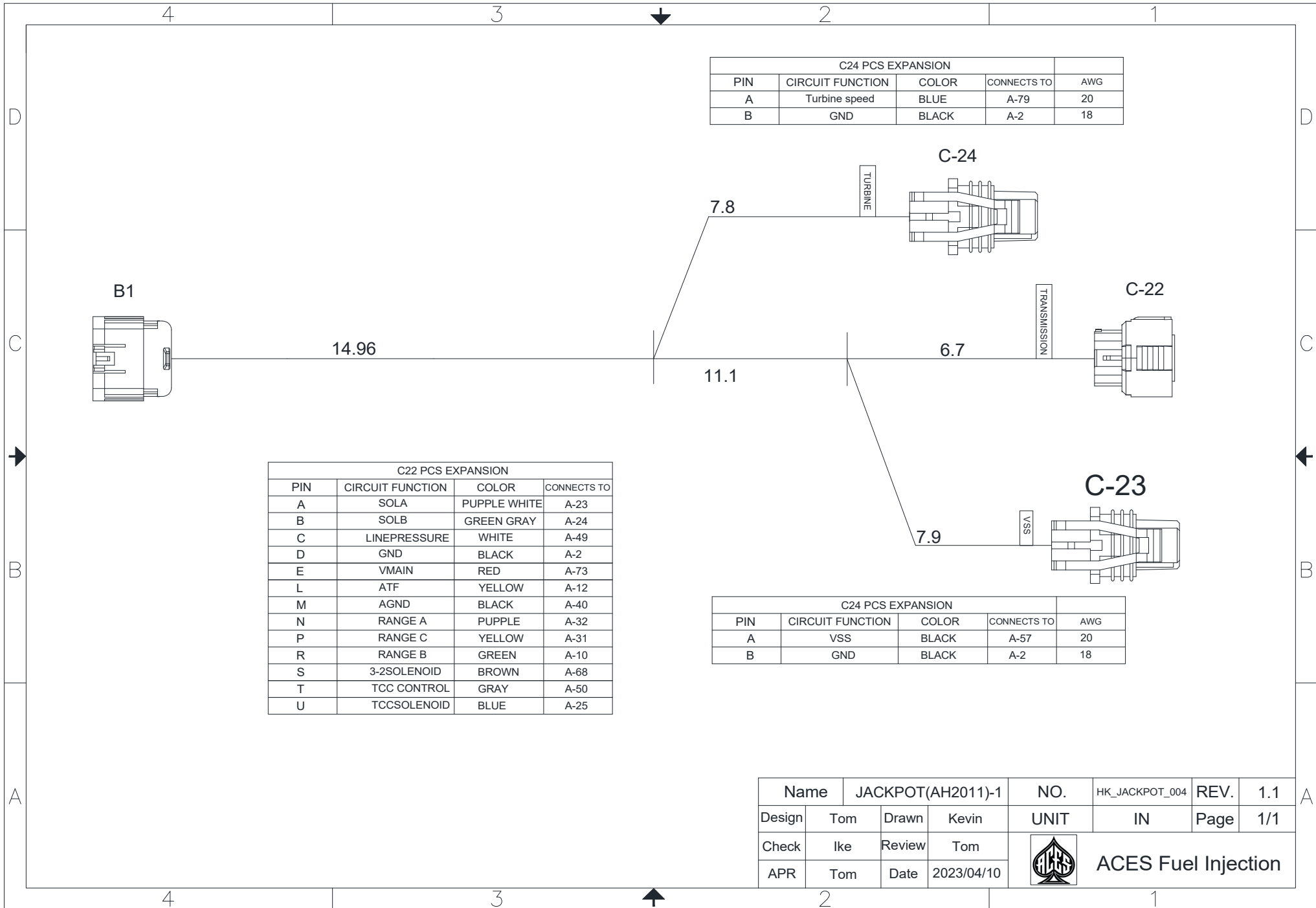

C24 PCS EXPANSION				
PIN	CIRCUIT FUNCTION	COLOR	CONNECTS TO	AWG
A	Turbine speed	BLUE	A-79	20
B	GND	BLACK	A-2	18

C22 PCS EXPANSION			
PIN	CIRCUIT FUNCTION	COLOR	CONNECTS TO
A	SOLA	PURPLE WHITE	A-23
B	SOLB	GREEN GRAY	A-24
C	LINEPRESSURE	WHITE	A-49
D	GND	BLACK	A-2
E	VMAIN	RED	A-73
L	ATF	YELLOW	A-12
M	AGND	BLACK	A-40
N	RANGE A	PURPLE	A-32
P	RANGE C	YELLOW	A-31
R	RANGE B	GREEN	A-10
S	3-2SOLENOID	BROWN	A-68
T	TCC CONTROL	GRAY	A-50
U	TCCSOLENOID	BLUE	A-25

C24 PCS EXPANSION				
PIN	CIRCUIT FUNCTION	COLOR	CONNECTS TO	AWG
A	VSS	BLACK	A-57	20
B	GND	BLACK	A-2	18

Name		JACKPOT(AH2011)-1		NO.	HK_JACKPOT_004	REV.	1.1
Design	Tom	Drawn	Kevin	UNIT	IN	Page	1/1
Check	Ike	Review	Tom		ACES Fuel Injection		
APR	Tom	Date	2023/04/10				

Coil Harness AH2011-2

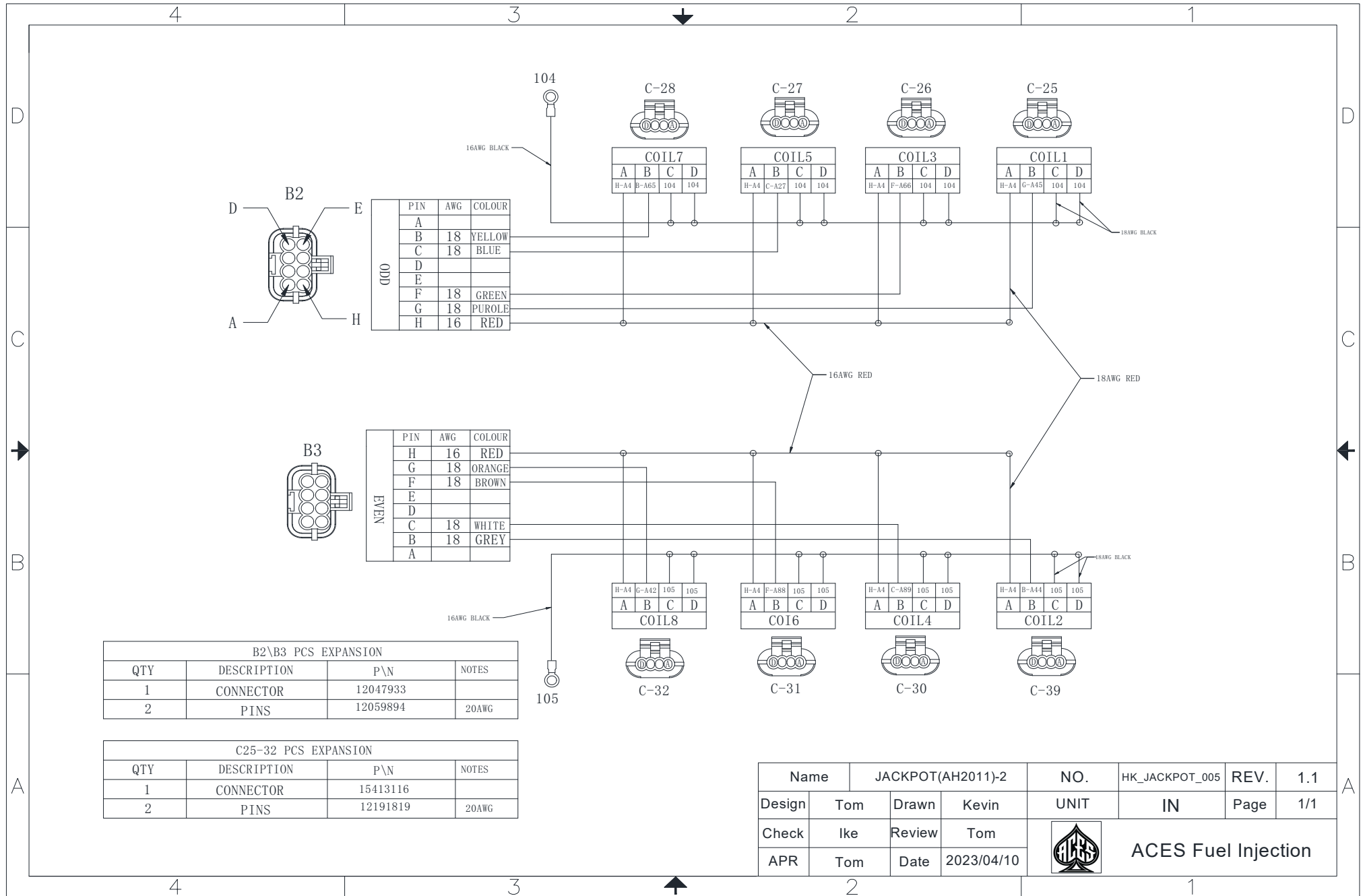

B2\B3 PCS EXPANSION			
QTY	DESCRIPTION	P\N	NOTES
1	CONNECTOR	12047933	
2	PINS	12059894	20AWG

C25-32 PCS EXPANSION			
QTY	DESCRIPTION	P\N	NOTES
1	CONNECTOR	15413116	
2	PINS	12191819	20AWG

Name	JACKPOT(AH2011)-2			NO.	HK_JACKPOT_005	REV.	1.1
Design	Tom	Drawn	Kevin	UNIT	IN	Page	1/1
Check	Ike	Review	Tom	 ACES Fuel Injection			
APR	Tom	Date	2023/04/10				

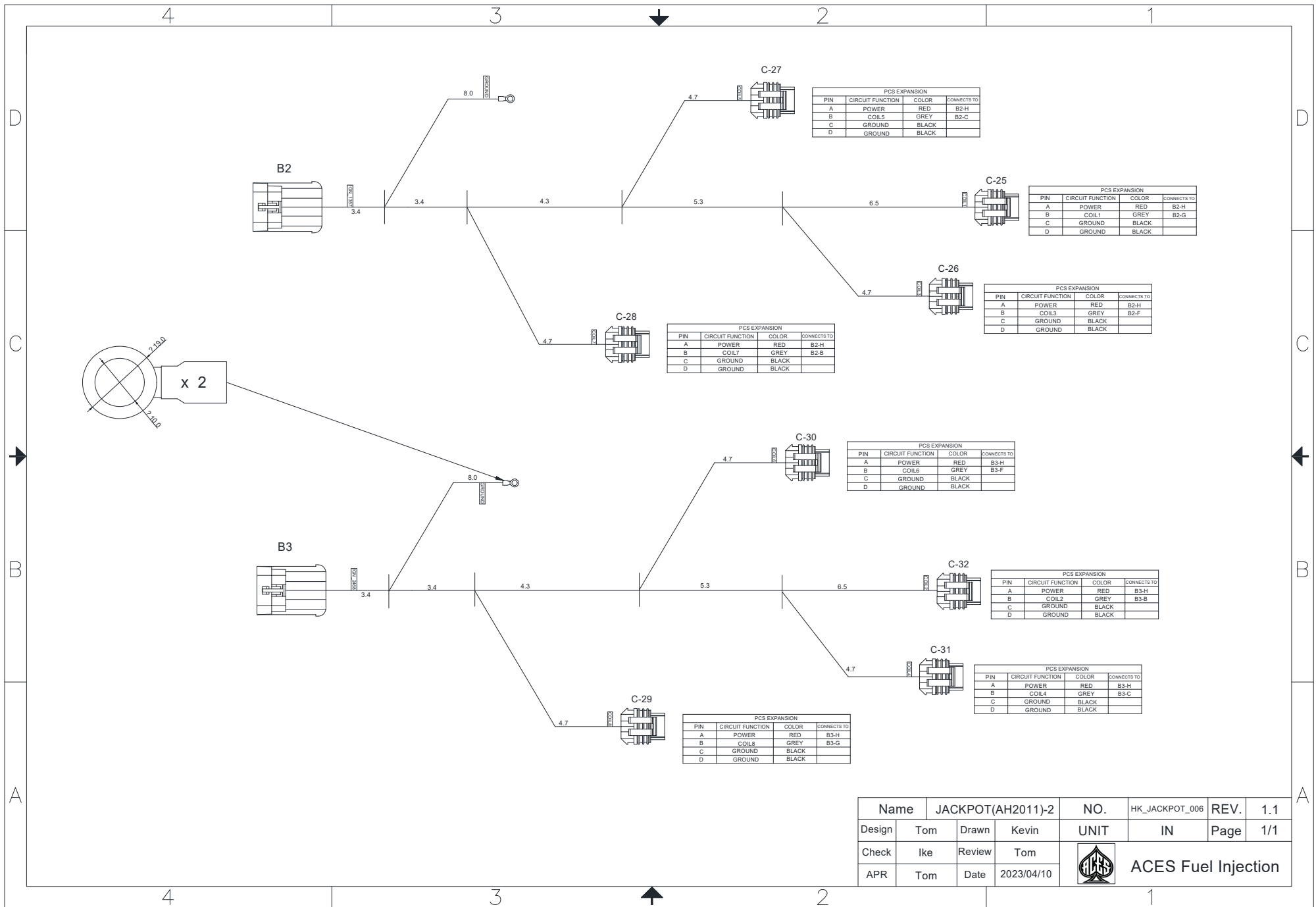

PCS EXPANSION			
PIN	CIRCUIT FUNCTION	COLOR	CONNECTS TO
A	POWER	RED	B2-H
B	COIL5	GREY	B2-C
C	GROUND	BLACK	
D	GROUND	BLACK	

PCS EXPANSION			
PIN	CIRCUIT FUNCTION	COLOR	CONNECTS TO
A	POWER	RED	B2-H
B	COIL1	GREY	B2-G
C	GROUND	BLACK	
D	GROUND	BLACK	

PCS EXPANSION			
PIN	CIRCUIT FUNCTION	COLOR	CONNECTS TO
A	POWER	RED	B2-H
B	COIL3	GREY	B2-F
C	GROUND	BLACK	
D	GROUND	BLACK	

PCS EXPANSION			
PIN	CIRCUIT FUNCTION	COLOR	CONNECTS TO
A	POWER	RED	B2-H
B	COIL7	GREY	B2-B
C	GROUND	BLACK	
D	GROUND	BLACK	

PCS EXPANSION			
PIN	CIRCUIT FUNCTION	COLOR	CONNECTS TO
A	POWER	RED	B3-H
B	COIL6	GREY	B3-F
C	GROUND	BLACK	
D	GROUND	BLACK	

PCS EXPANSION			
PIN	CIRCUIT FUNCTION	COLOR	CONNECTS TO
A	POWER	RED	B3-H
B	COIL2	GREY	B3-B
C	GROUND	BLACK	
D	GROUND	BLACK	

PCS EXPANSION			
PIN	CIRCUIT FUNCTION	COLOR	CONNECTS TO
A	POWER	RED	B3-H
B	COIL5	GREY	B3-G
C	GROUND	BLACK	
D	GROUND	BLACK	

PCS EXPANSION			
PIN	CIRCUIT FUNCTION	COLOR	CONNECTS TO
A	POWER	RED	B3-H
B	COIL4	GREY	B3-C
C	GROUND	BLACK	
D	GROUND	BLACK	

Name	JACKPOT(AH2011)-2		NO.	HK_JACKPOT_006	REV.	1.1
Design	Tom	Drawn	Kevin	UNIT	IN	Page 1/1
Check	Ike	Review	Tom	 ACES Fuel Injection		
APR	Tom	Date	2023/04/10			

Injector Harness AH2011-3

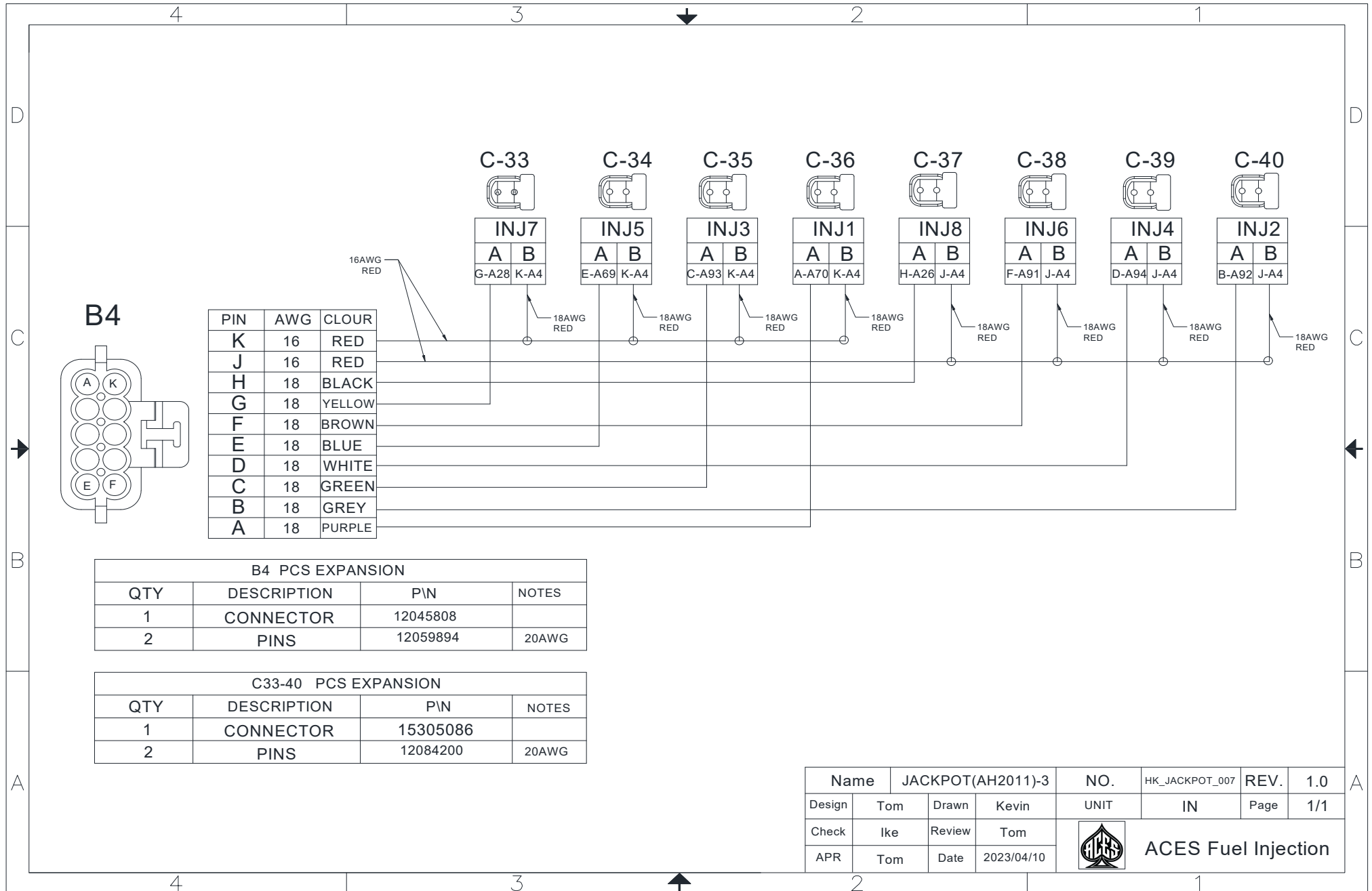

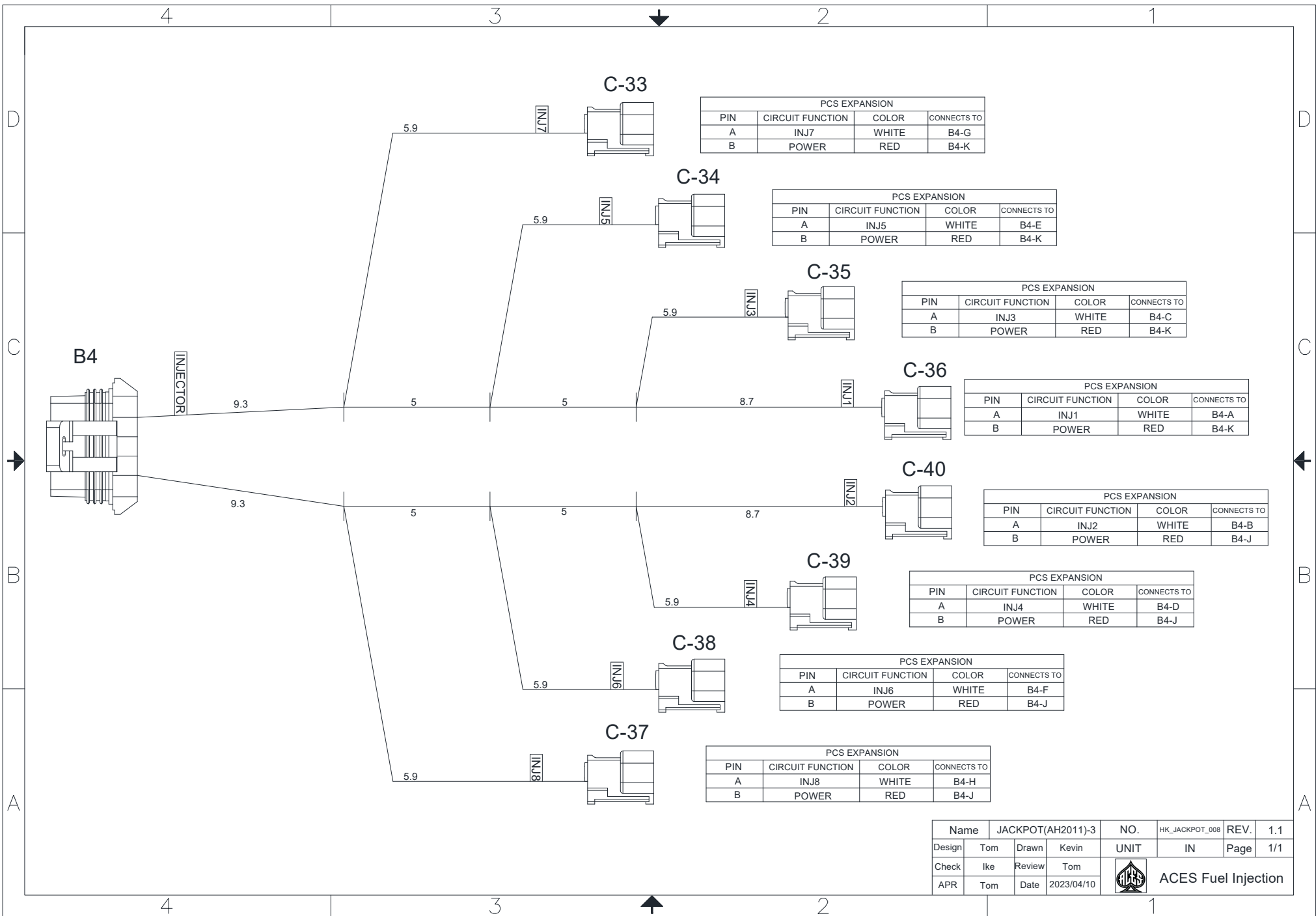

PCS EXPANSION			
PIN	CIRCUIT FUNCTION	COLOR	CONNECTS TO
A	INJ7	WHITE	B4-G
B	POWER	RED	B4-K

PCS EXPANSION			
PIN	CIRCUIT FUNCTION	COLOR	CONNECTS TO
A	INJ5	WHITE	B4-E
B	POWER	RED	B4-K

PCS EXPANSION			
PIN	CIRCUIT FUNCTION	COLOR	CONNECTS TO
A	INJ3	WHITE	B4-C
B	POWER	RED	B4-K

PCS EXPANSION			
PIN	CIRCUIT FUNCTION	COLOR	CONNECTS TO
A	INJ1	WHITE	B4-A
B	POWER	RED	B4-K

PCS EXPANSION			
PIN	CIRCUIT FUNCTION	COLOR	CONNECTS TO
A	INJ2	WHITE	B4-B
B	POWER	RED	B4-J

PCS EXPANSION			
PIN	CIRCUIT FUNCTION	COLOR	CONNECTS TO
A	INJ4	WHITE	B4-D
B	POWER	RED	B4-J

PCS EXPANSION			
PIN	CIRCUIT FUNCTION	COLOR	CONNECTS TO
A	INJ6	WHITE	B4-F
B	POWER	RED	B4-J

PCS EXPANSION			
PIN	CIRCUIT FUNCTION	COLOR	CONNECTS TO
A	INJ8	WHITE	B4-H
B	POWER	RED	B4-J

Name	JACKPOT(AH2011)-3		NO.	HK_JACKPOT_008	REV.	1.1
Design	Tom	Drawn	Kevin	UNIT	IN	Page 1/1
Check	Ike	Review	Tom	 ACES Fuel Injection		
APR	Tom	Date	2023/04/10			

DBW and Pedal Harness AH2011-4

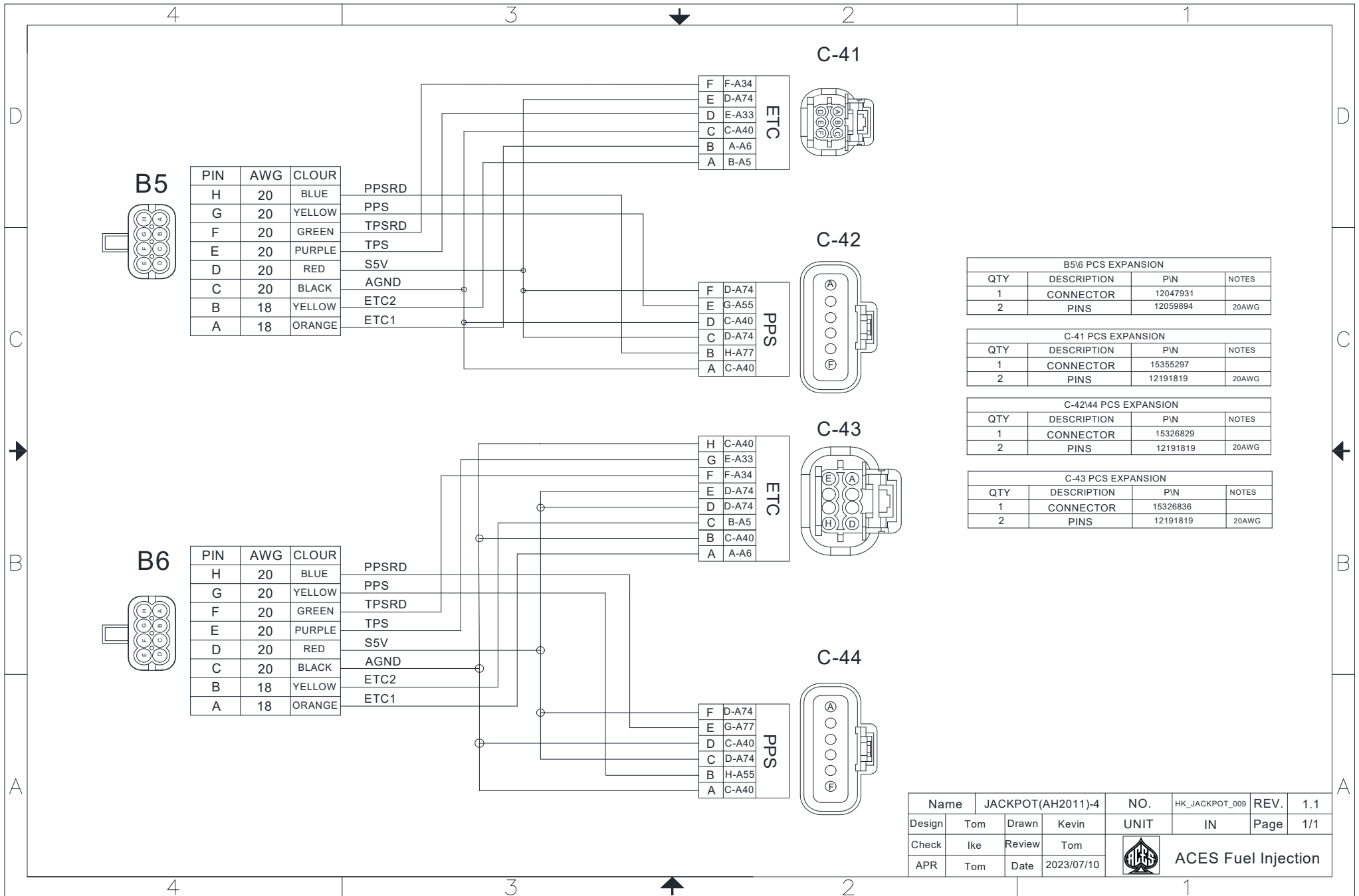

Name	JACKPOT(AH2011)-4	NO.	HK_JACKPOT_009	REV.	1.1
Design	Tom	Drawn	Kevin	UNIT	IN
Check	Ike	Review	Tom	Page	1/1
APR	Tom	Date	2023/07/10	 ACES Fuel Injection	

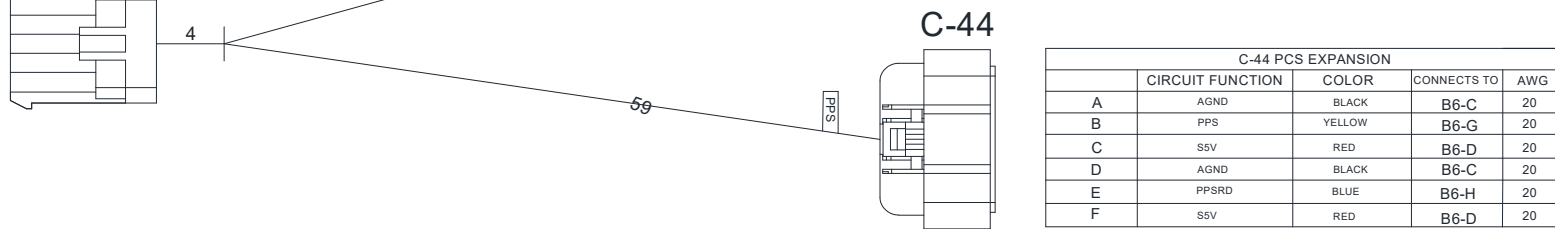
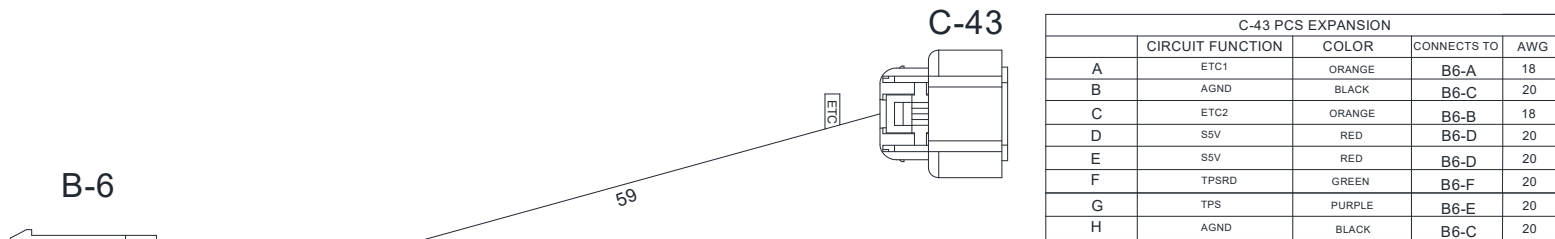
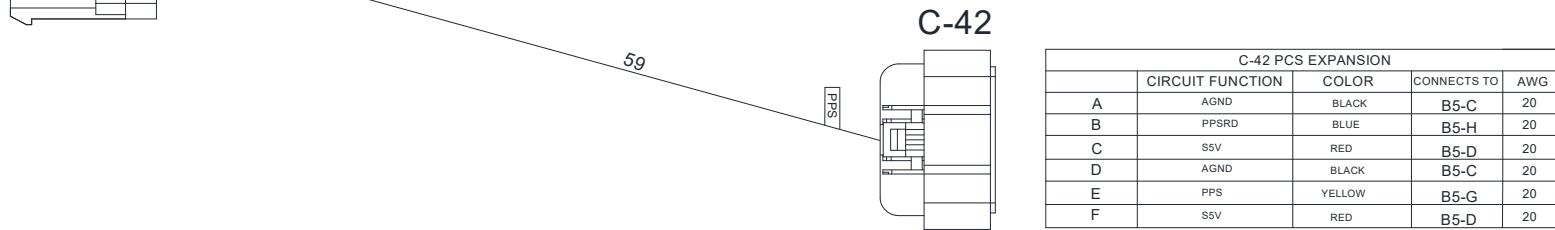
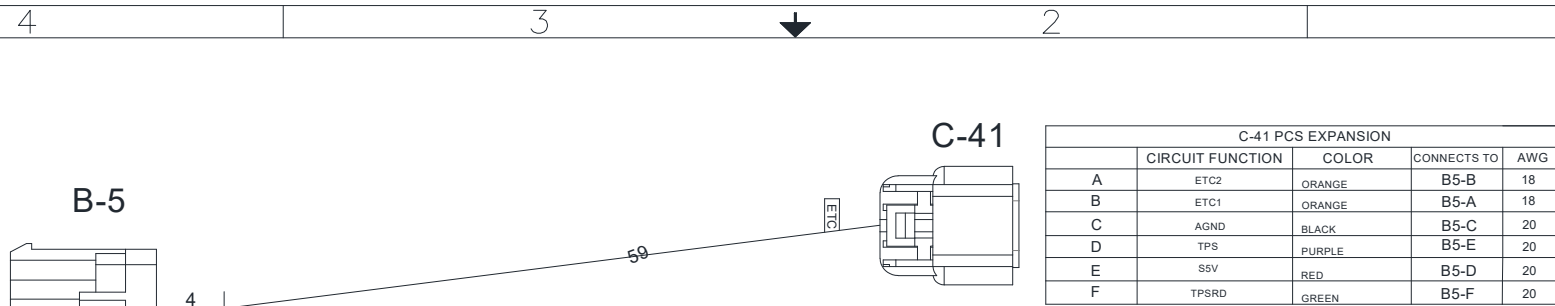

Name		JACKPOT(AH2011)-4		NO.	HK_JACKPOT_010	REV.	1.1
Design	Tom	Drawn	Kevin	UNIT	IN	Page	1/1
Check	Ike	Review	Tom		ACES Fuel Injection		
APR	Tom	Date	2023/07/10				

Crank and Cam Harness AH2011-5

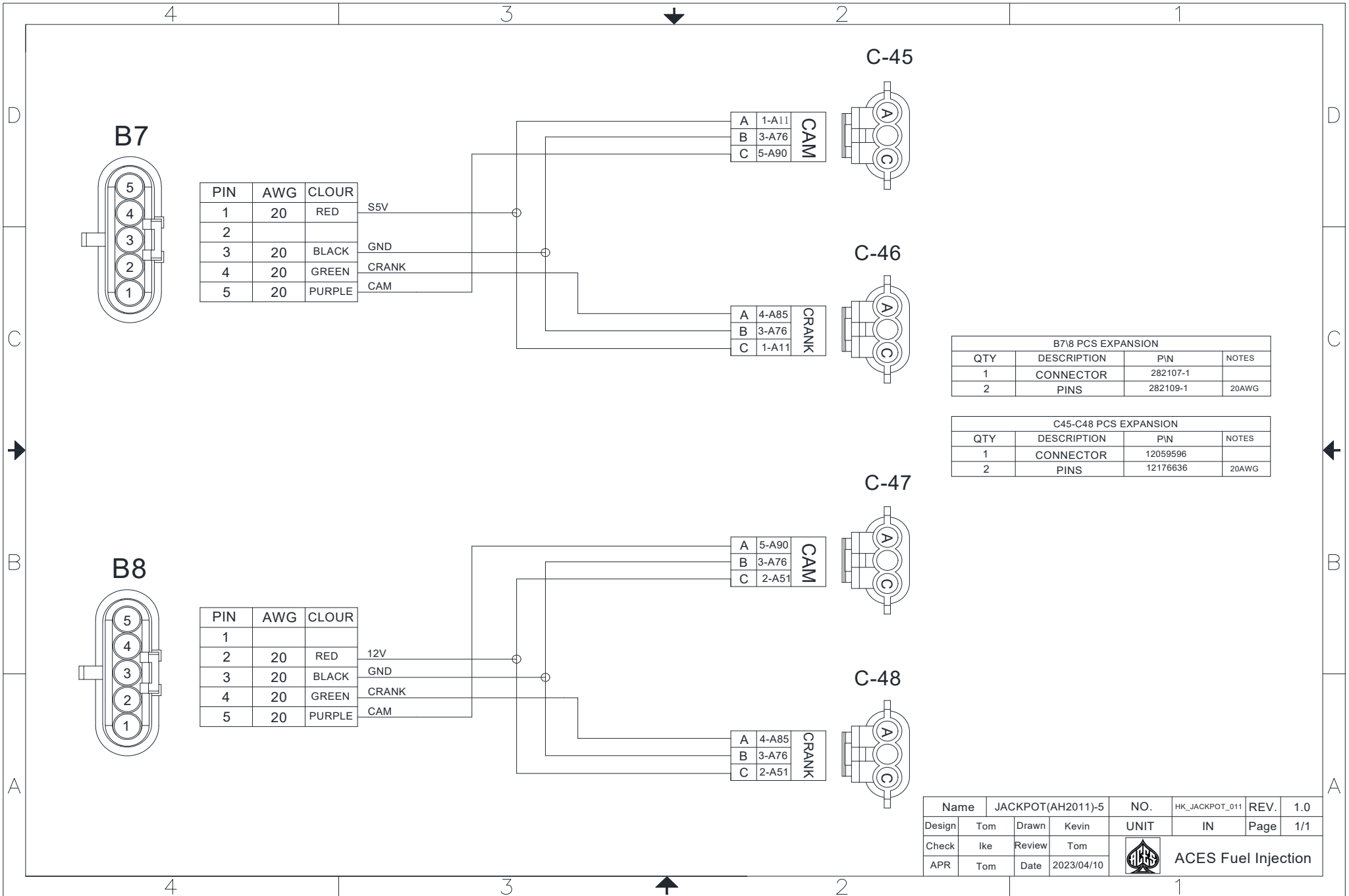

B7/8 PCS EXPANSION			
QTY	DESCRIPTION	PIN	NOTES
1	CONNECTOR	282107-1	
2	PINS	282109-1	20AWG

C45-C48 PCS EXPANSION			
QTY	DESCRIPTION	PIN	NOTES
1	CONNECTOR	12059596	
2	PINS	12176636	20AWG

Name	JACKPOT(AH2011)-5	NO.	HK_JACKPOT_011	REV.	1.0
Design	Tom	Drawn	Kevin	UNIT	IN
Check	Ike	Review	Tom	Page	1/1
APR	Tom	Date	2023/04/10	 ACES Fuel Injection	

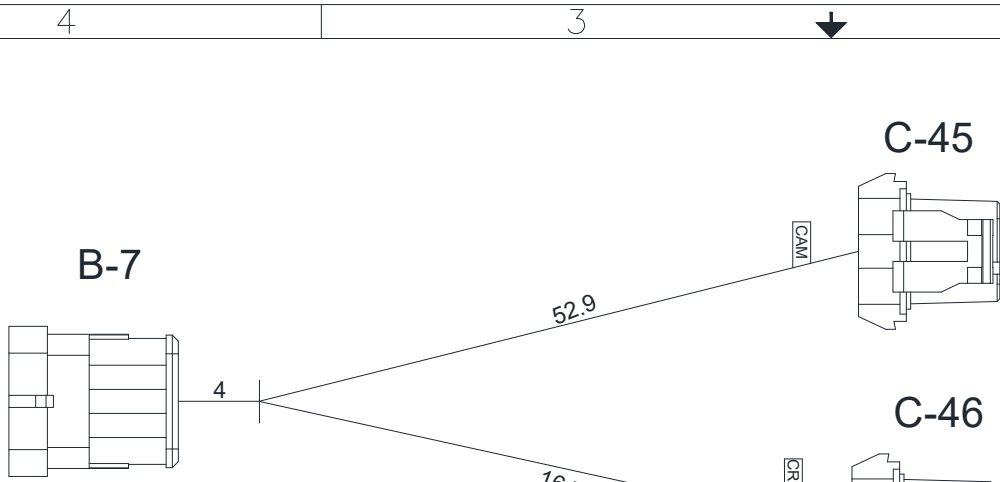

C-45 PCS EXPANSION				
	CIRCUIT FUNCTION	COLOR	CONNECTS TO	AWG
A	S5V	RED	B7-1	20
B	GND	BLACK	B7-3	20
C	CAM	PURPLE	B7-5	20

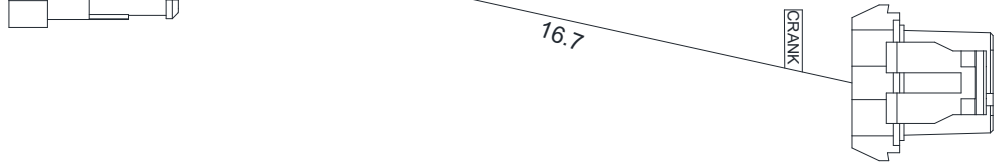

C-46 PCS EXPANSION				
	CIRCUIT FUNCTION	COLOR	CONNECTS TO	AWG
A	CRANK	GREEN	B7-4	20
B	GND	BLACK	B7-3	20
C	S5V	RED	B7-1	20

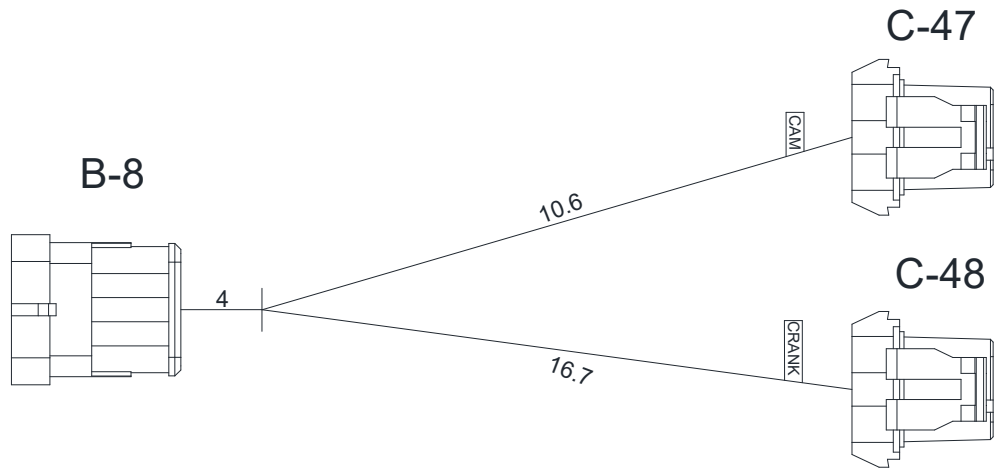

C-47 PCS EXPANSION				
	CIRCUIT FUNCTION	COLOR	CONNECTS TO	AWG
A	CAM	PURPLE	B8-5	20
B	GND	BLACK	B8-3	20
C	VMAIN	RED	B8-2	20

C-48 PCS EXPANSION				
	CIRCUIT FUNCTION	COLOR	CONNECTS TO	AWG
A	CRANK	GREEN	B8-4	20
B	GND	BLACK	B8-3	20
C	VMAIN	RED	B8-2	20

Name		JACKPOT(AH2011)-5		NO.	HK_JACKPOT_012	REV.	1.0
Design	Tom	Drawn	Kevin	UNIT	IN	Page	1/1
Check	Ike	Review	Tom	 ACES Fuel Injection			
APR	Tom	Date	2023/04/10				

Knock sub harness AH2011-6

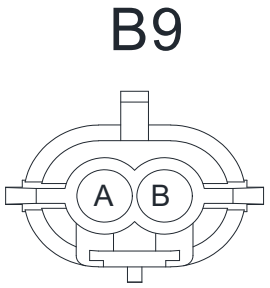
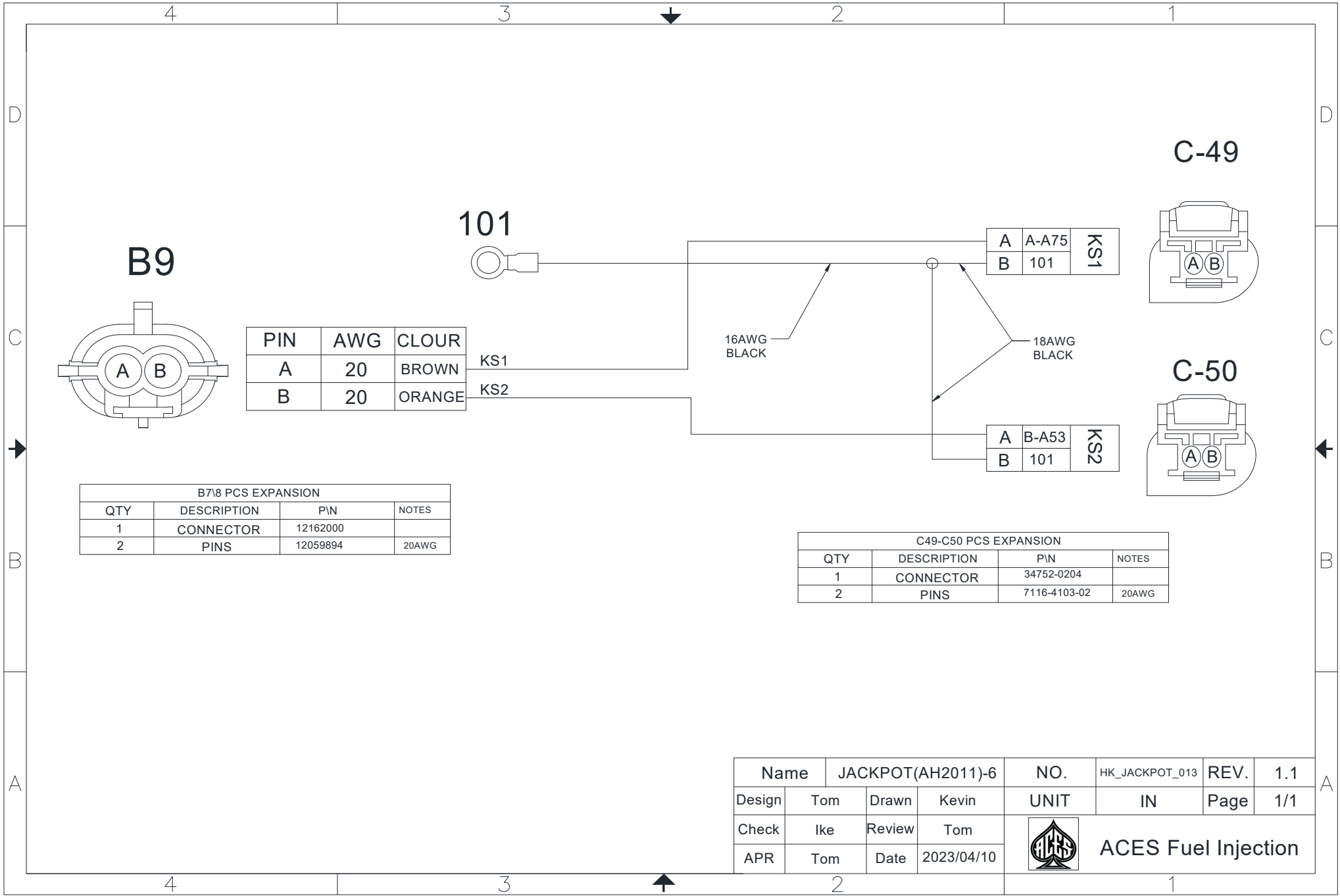

PIN	AWG	CLOUR
A	20	BROWN
B	20	ORANGE



PIN	AWG	CLOUR
A	A-A75	
B	101	

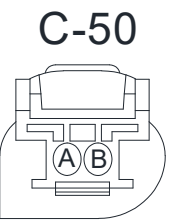
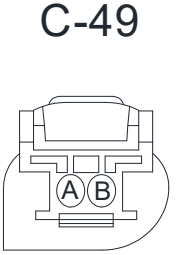

B78 PCS EXPANSION			
QTY	DESCRIPTION	PIN	NOTES
1	CONNECTOR	12162000	
2	PINS	12059894	20AWG

C49-C50 PCS EXPANSION			
QTY	DESCRIPTION	PIN	NOTES
1	CONNECTOR	34752-0204	
2	PINS	7116-4103-02	20AWG

Name	JACKPOT(AH2011)-6			NO.	HK_JACKPOT_013	REV.	1.1
Design	Tom	Drawn	Kevin	UNIT	IN	Page	1/1
Check	Ike	Review	Tom	 ACES Fuel Injection			
APR	Tom	Date	2023/04/10				

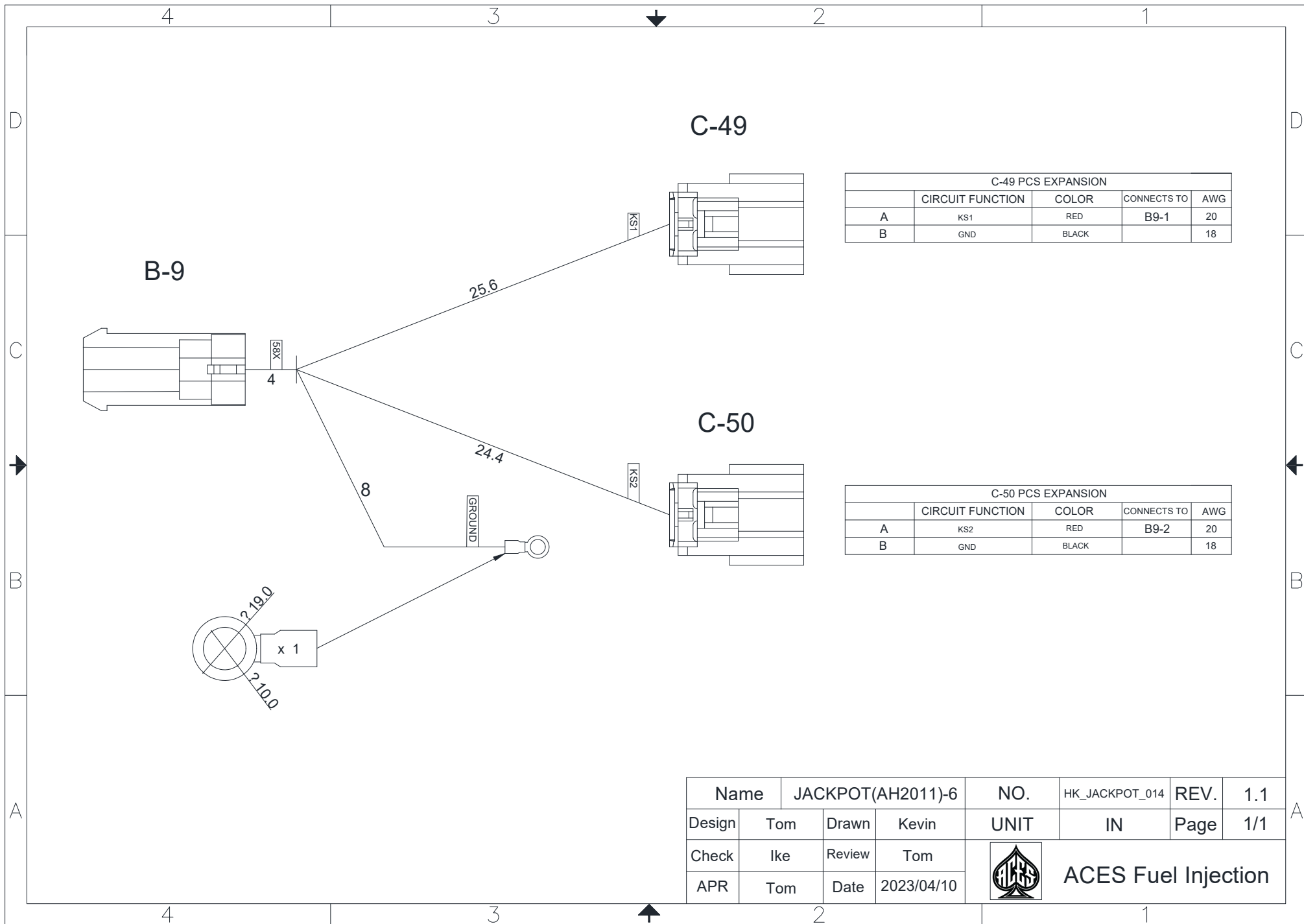

Name	JACKPOT(AH2011)-6			NO.	HK_JACKPOT_014	REV.	1.1
Design	Tom	Drawn	Kevin	UNIT	IN	Page	1/1
Check	Ike	Review	Tom		ACES Fuel Injection		
APR	Tom	Date	2023/04/10				

Sensor sub harness AH2011-7

C55 PCS EXPANSION			
QTY	DESCRIPTION	PIN	NOTES
1	CONNECTOR	15354716	
2	PINS	12191819	20AWG

C52 PCS EXPANSION			
QTY	DESCRIPTION	PIN	NOTES
1	CONNECTOR	12059596	
2	PINS	12176636	20AWG

C53 PCS EXPANSION			
QTY	DESCRIPTION	PIN	NOTES
1	CONNECTOR	15335987	
2	PINS	12191819	20AWG

C54 PCS EXPANSION			
QTY	DESCRIPTION	PIN	NOTES
1	CONNECTOR	15397275	
2	PINS	12191819	20AWG

B10 PCS EXPANSION			
QTY	DESCRIPTION	PIN	NOTES
1	CONNECTOR	12045808	
2	PINS	12059894	20AWG

PIN	AWG	CLOUR	
K	20	RED	S5V
J	20	PURPLE	TPS
H	20	BLACK	AGND
G	20	BLUE	MAP
F	20	WHITE	IAT
E	20	BLACK	AGND
D	20	GREEN	OUTD
C	20	PURPLE	OUTC
B	20	YELLOW	OUTB
A	20	ORANGE	OUTA

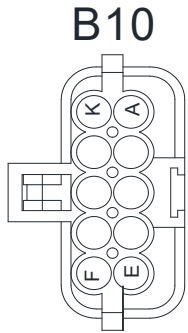
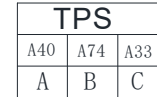
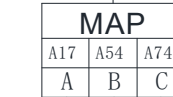
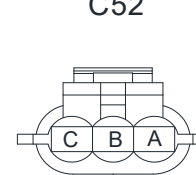
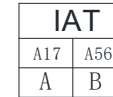
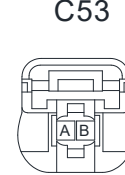
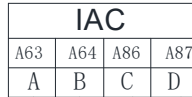
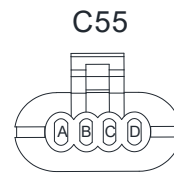

Name		JACKPOT(AH2011)-7		NO.	HK_JACKPOT_015	REV.	1.2
Design	Tom	Drawn	Kevin	UNIT	IN	Page	1/1
Check	Ike	Review	Tom	 ACES Fuel Injection			
APR	Tom	Date	2023/04/10				

C55 PCS EXPANSION			
PIN	CIRCUIT FUNCTION	COLOR	CONNECTS TO
A	OUTA	PURPLE	A1-A
B	OUTB	GREEN	A1-B
C	OUTC	BLUE	A1-C
D	OUTD	YELLOW	A1-D

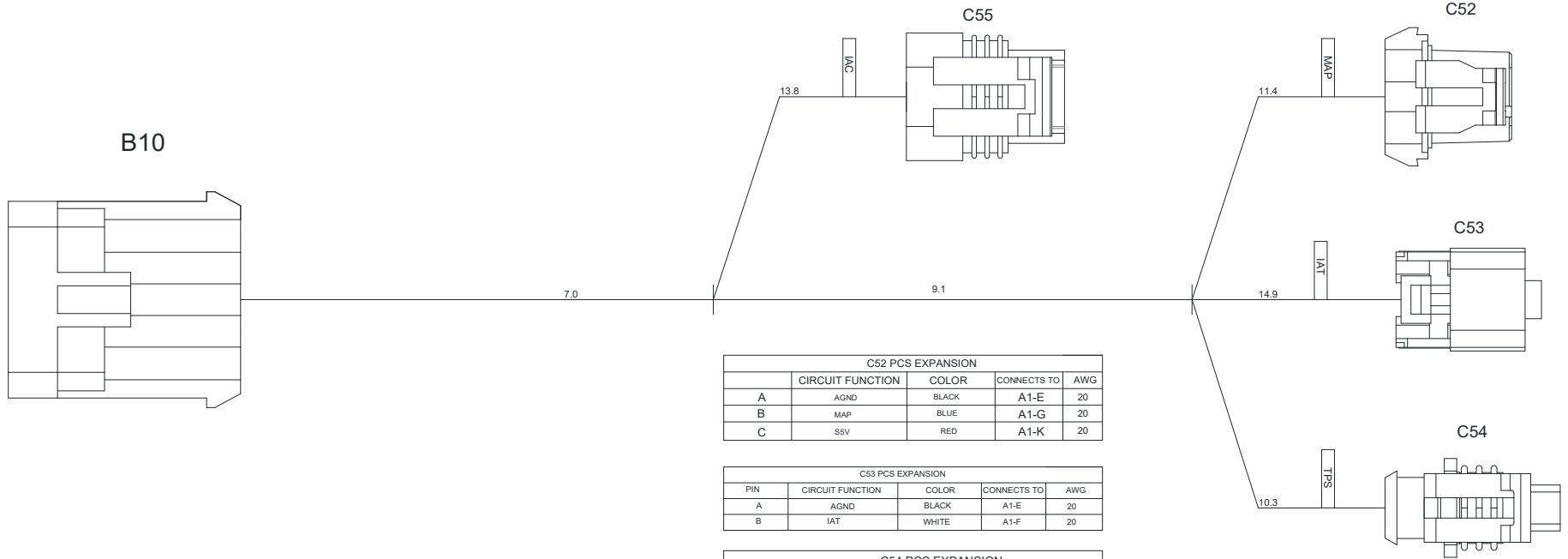

C52 PCS EXPANSION				
	CIRCUIT FUNCTION	COLOR	CONNECTS TO	AWG
A	AGND	BLACK	A1-E	20
B	MAP	BLUE	A1-G	20
C	S5V	RED	A1-K	20

C53 PCS EXPANSION				
PIN	CIRCUIT FUNCTION	COLOR	CONNECTS TO	AWG
A	AGND	BLACK	A1-E	20
B	IAT	WHITE	A1-F	20

C54 PCS EXPANSION			
PIN	CIRCUIT FUNCTION	COLOR	CONNECTS TO
A	S5V	RED	A1-K
B	AGND	BLACK	A1-H
C	TPS	BROWN	A1-J

Name		JACKPOT(AH2011)-7		NO.	HK_JACKPOT_016	REV.	1.2
Design	Tom	Drawn	Kevin	UNIT	IN	Page	1/1
Check	Ike	Review	Tom	 ACES Fuel Injection			
APR	Tom	Date	2023/04/10				

Sensor sub harness AH2011-8

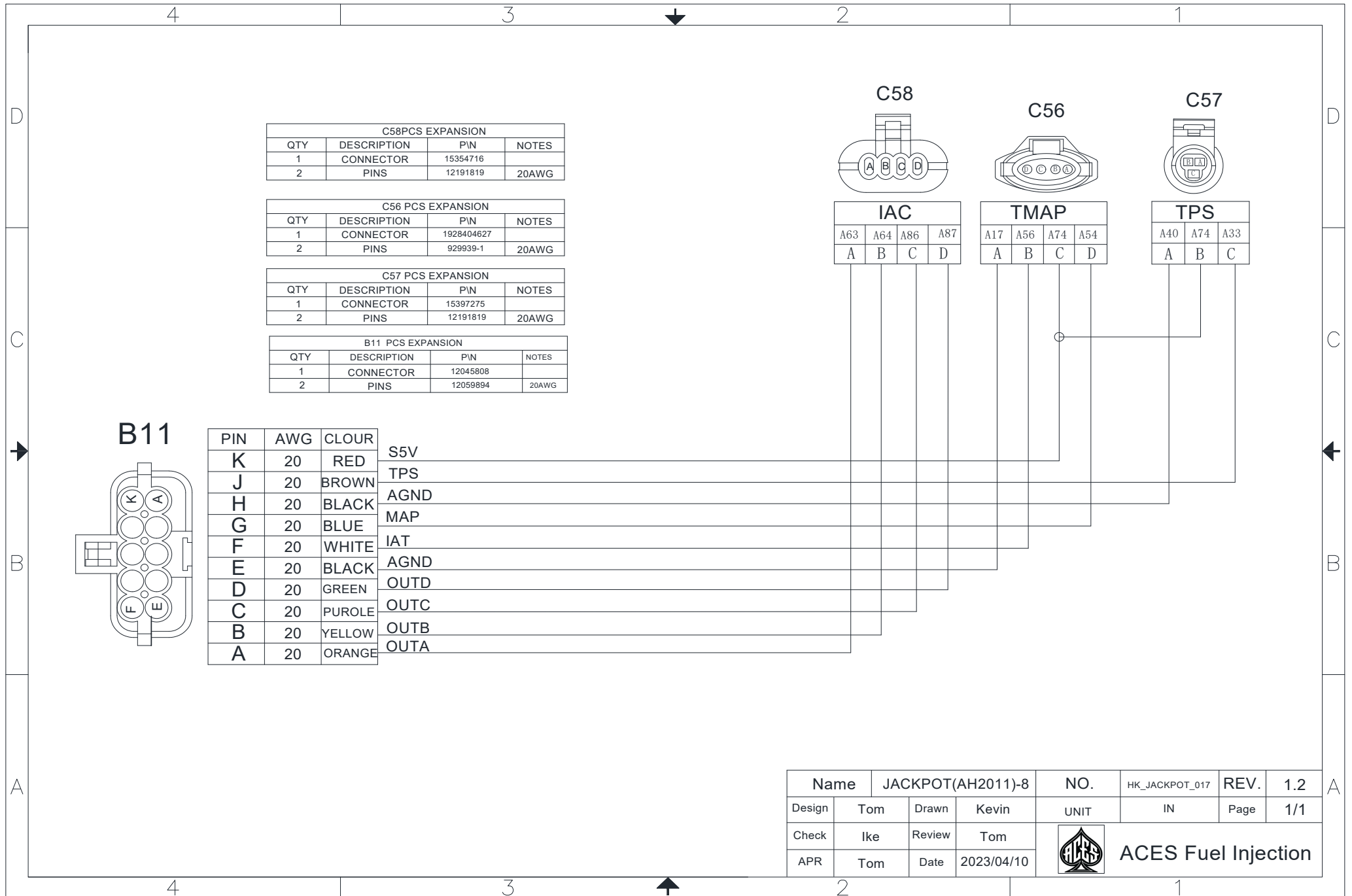

C58PCS EXPANSION			
QTY	DESCRIPTION	PIN	NOTES
1	CONNECTOR	15354716	
2	PINS	12191819	20AWG

C56 PCS EXPANSION			
QTY	DESCRIPTION	PIN	NOTES
1	CONNECTOR	1928404627	
2	PINS	929939-1	20AWG

C57 PCS EXPANSION			
QTY	DESCRIPTION	PIN	NOTES
1	CONNECTOR	15397275	
2	PINS	12191819	20AWG

B11 PCS EXPANSION			
QTY	DESCRIPTION	PIN	NOTES
1	CONNECTOR	12045808	
2	PINS	12059894	20AWG

PIN	AWG	CLOUR	
K	20	RED	S5V
J	20	BROWN	TPS
H	20	BLACK	AGND
G	20	BLUE	MAP
F	20	WHITE	IAT
E	20	BLACK	AGND
D	20	GREEN	OUTD
C	20	PURPLE	OUTC
B	20	YELLOW	OUTB
A	20	ORANGE	OUTA

Name		JACKPOT(AH2011)-8		NO.	HK_JACKPOT_017	REV.	1.2
Design	Tom	Drawn	Kevin	UNIT	IN	Page	1/1
Check	Ike	Review	Tom	 ACES Fuel Injection			
APR	Tom	Date	2023/04/10				

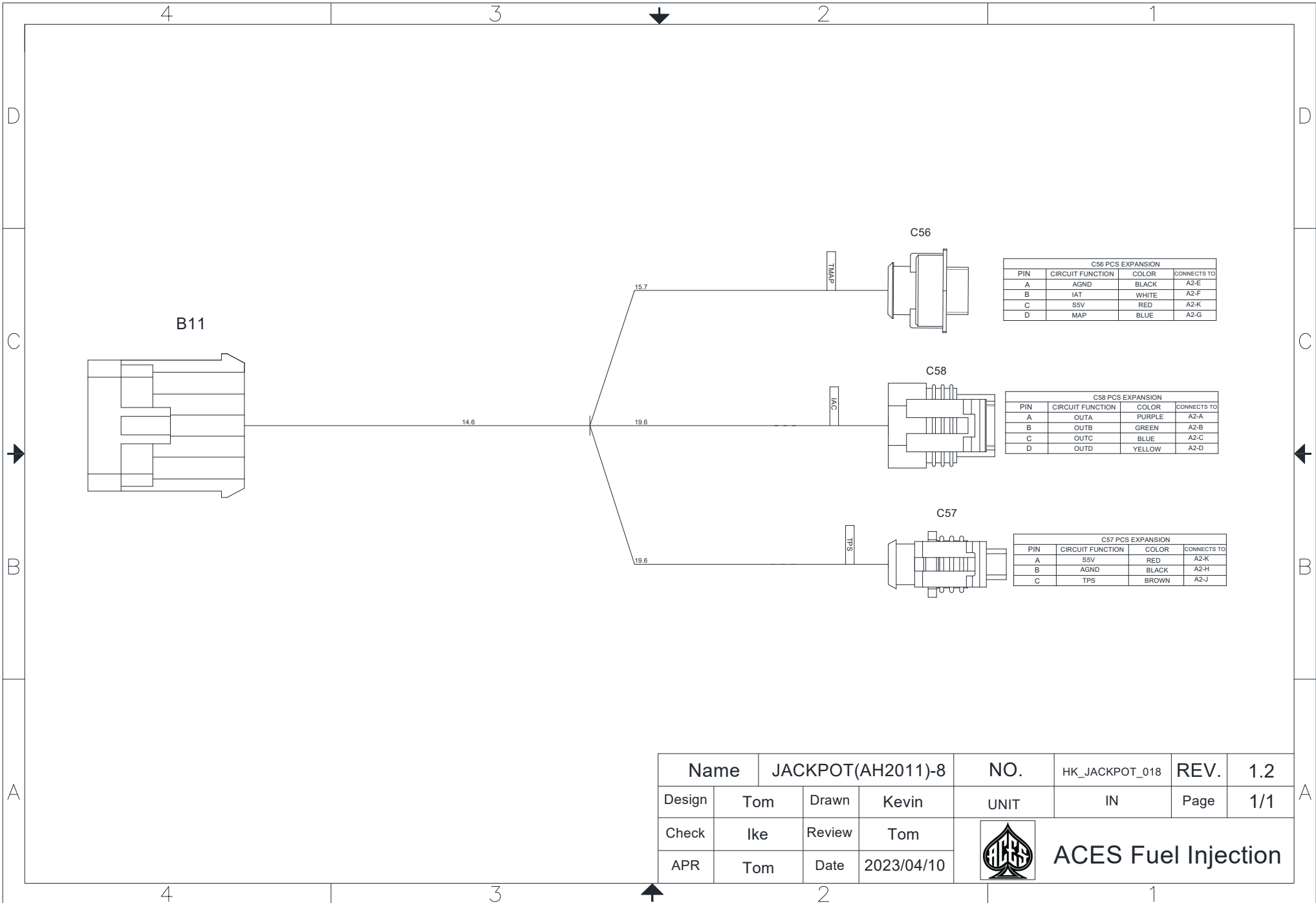

Name		JACKPOT(AH2011)-8		NO.	HK_JACKPOT_018	REV.	1.2
Design	Tom	Drawn	Kevin	UNIT	IN	Page	1/1
Check	Ike	Review	Tom	 ACES Fuel Injection			
APR	Tom	Date	2023/04/10				

Additional wire AH2011-9

4 3 2 1

D C B A

D C B A

B12

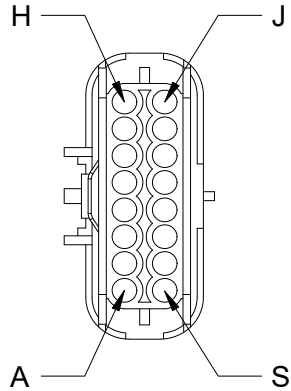

PIN	AWG	COLOUR
A	14	RED
B	20	BLUE
C	20	YELLOW
D	20	YELLOW
E	20	PURPLE
F	20	BULE
G	20	BROWN
H	20	GREY
J	20	GREEN
K	20	RED
L	20	BROWN
M	20	BLUE
N	18	BROWN
P	18	BLACK
R	20	PURPLE
S	20	BROWN

VMAIN
LAUNCH
AC-REQ
BURN
FAN1
REV
STEP
TACH-OUT
FAN2
POWER-EN
BRAKE SWITCH
VSS
WASTE1
WASTE2
FULE LEVEL 1
FULE LEVEL 2

B1 PCS EXPANSION

QTY	DESCRIPTION	PIN	NOTES
1	CONNECTOR	15326084	
2	PINS	15326398	20AWG
3	PINS	15304720	14AWG

Name		JACKPOT(AH2011)-9		NO.	HK_JACKPOT_019	REV.	1.1
Design	Tom	Drawn	Kevin	UNIT	IN	Page	1/1
Check	Ike	Review	Tom	 ACES Fuel Injection			
APR	Tom	Date	2023/08/04				

4 3 2 1

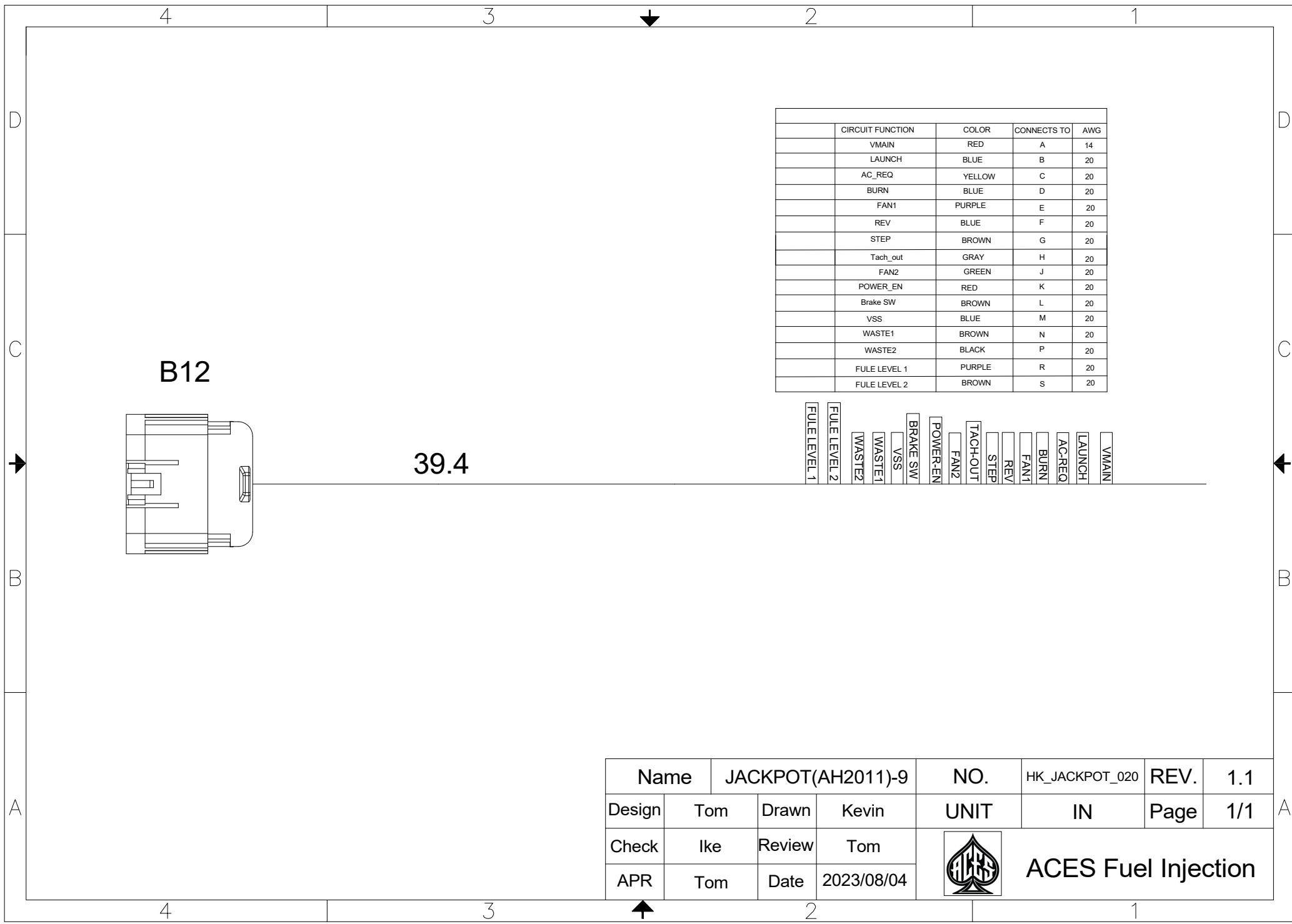

CIRCUIT FUNCTION	COLOR	CONNECTS TO	AWG
VMAIN	RED	A	14
LAUNCH	BLUE	B	20
AC_REQ	YELLOW	C	20
BURN	BLUE	D	20
FAN1	PURPLE	E	20
REV	BLUE	F	20
STEP	BROWN	G	20
Tach_out	GRAY	H	20
FAN2	GREEN	J	20
POWER_EN	RED	K	20
Brake SW	BROWN	L	20
VSS	BLUE	M	20
WASTE1	BROWN	N	20
WASTE2	BLACK	P	20
FULE LEVEL 1	PURPLE	R	20
FULE LEVEL 2	BROWN	S	20

B12

39.4

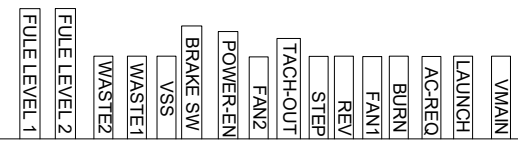

Name		JACKPOT(AH2011)-9		NO.	HK_JACKPOT_020	REV.	1.1
Design	Tom	Drawn	Kevin	UNIT	IN	Page	1/1
Check	Ike	Review	Tom	 ACES Fuel Injection			
APR	Tom	Date	2023/08/04				

Sensor sub harness AH2011-10

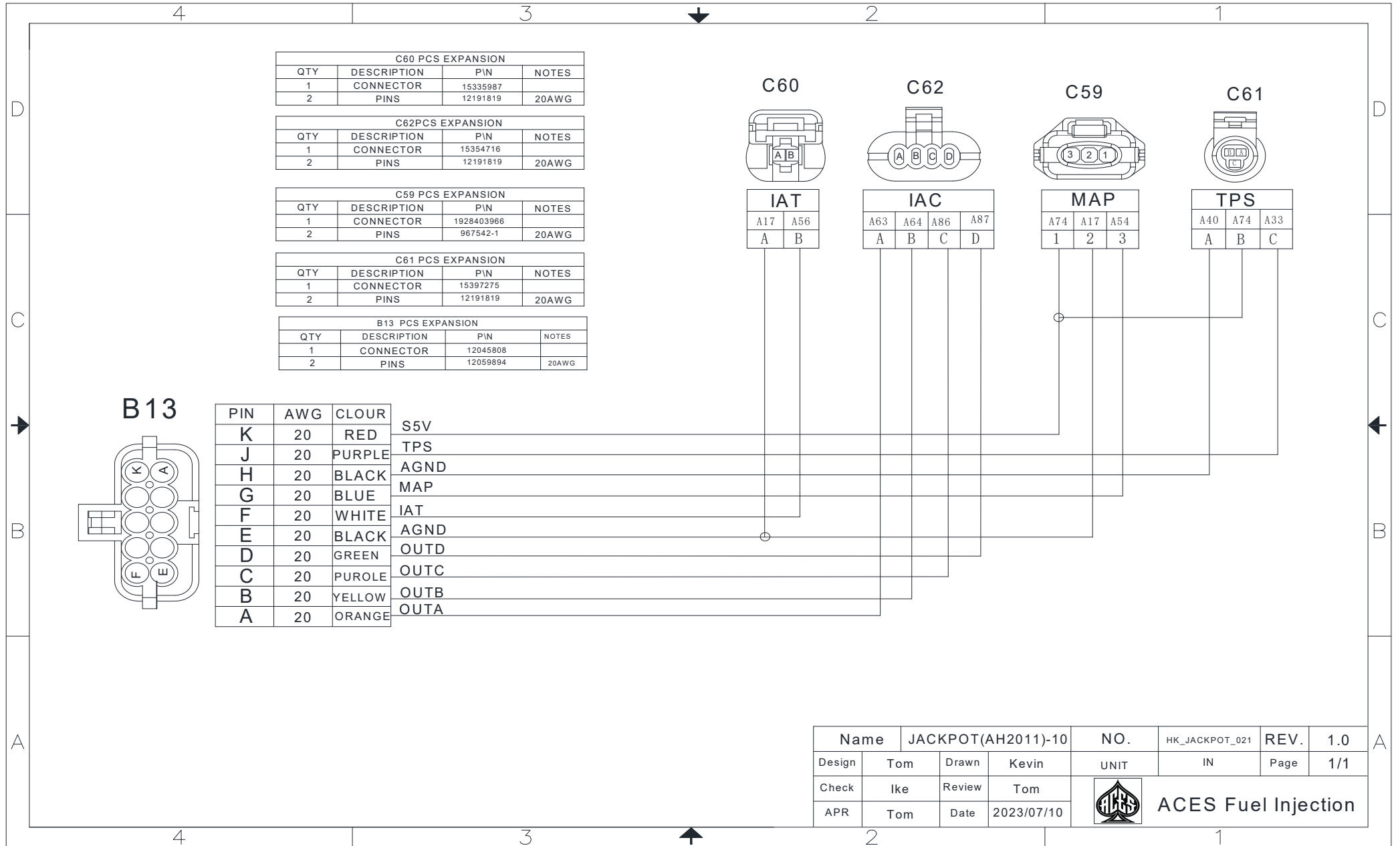

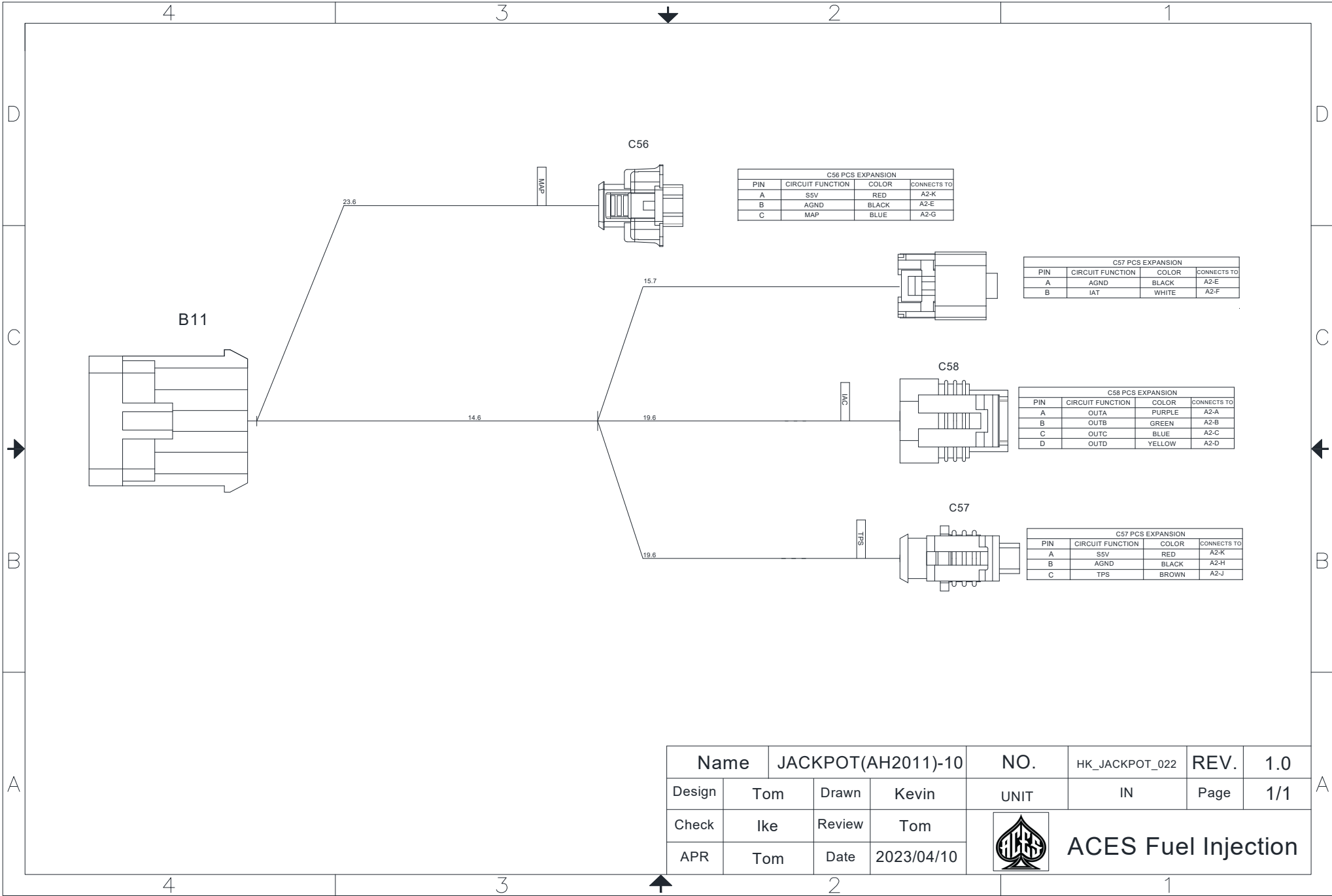

Name		JACKPOT(AH2011)-10		NO.	HK_JACKPOT_022	REV.	1.0
Design	Tom	Drawn	Kevin	UNIT	IN	Page	1/1
Check	Ike	Review	Tom	 ACES Fuel Injection			
APR	Tom	Date	2023/04/10				

ACES FUEL INJECTION TECHNICAL SUPPORT

10188 Dayton Pike

Soddy-Daisy, TN 37379

(423) 590-2237

www.acesefi.com