

SHP-DS705

USER MANUAL

Samsung SDS Digital Door Lock

Pairing with your Smart phone (3 page)
Conveniently open the door through the Bluetooth function of a smart phone.

Welcome Mode (4 page)
When a user gets close to the door lock, The authorization standby mode will automatically activate.

Silent Mode (5 page)
When going in or out, the sound of the key entering and door opening will be suspended.

Double Security (6 page)
Security check with the card and the password can be optionally applied.

At-home Security (7 page)
When someone is inside the house, authorization for entry from the outside will be prohibited.

High temperature Detection (8 page)
Generates alarm in case of a fire

Using the Emergency Battery (9 page)
Using the Emergency Battery

Setting guide (10, 11 page)

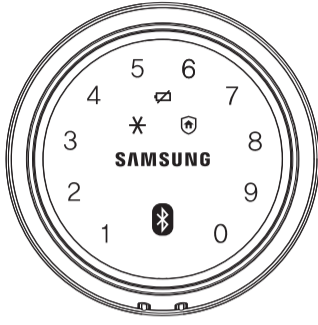

Product Components

The product components used may vary depending on the installation environment.

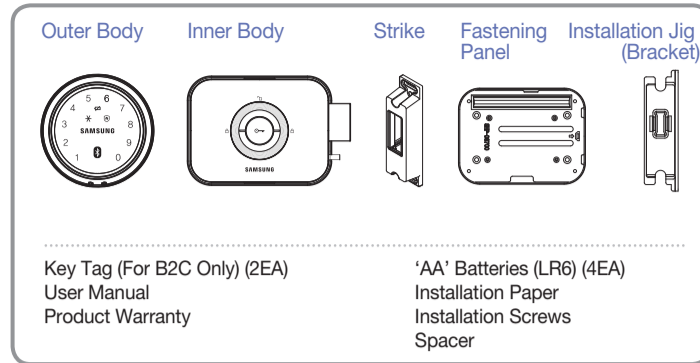

Outer Body Part

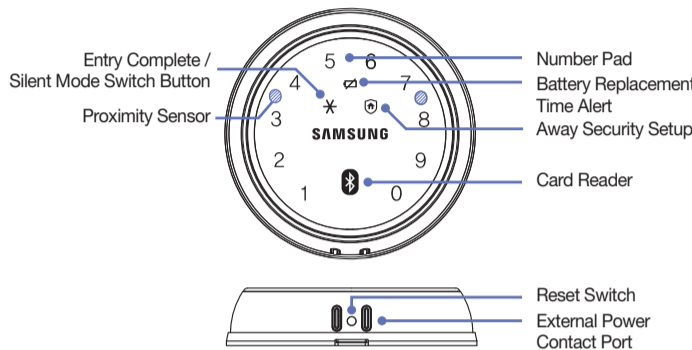

Inner Body Parts

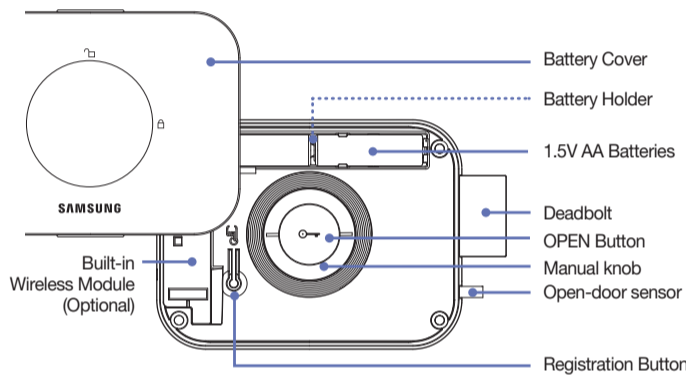

※ All registration and settings operate only when the door opens.

Pairing with your Smart phone

Download 'sHome Doorlock' from App Store / Google Play Store. For the more information about registering, please refer the description of application use.

Note

- Up to **eight** compatible smart phones can be paired.
- To pair multiple smart phones, turn off the Bluetooth of a paired smart phone, and pair another smart phone.
- If a registered Bluetooth enabled smart phone is lost or repaired, your registration information cannot be deleted from the door lock. It is recommend that the door lock should be initialized. (Refer page 7)
- Please check support smart phone model on the web page.

Password Register/ Change

The password can be 4~12 digits number. Only one password can be registered. The initial password is set to '1234'.

1. Pressing the [Register] Button 2. Entering the Current Password



Success:
DING DONG DENG
→ DING DING
Fail:
DING DONG DING DONG

Open the battery cover of the inner body and briefly press the [Register] button.

When the number pad is lighted, enter the current password('1234' after initialization) and then press the [*] button.

3. Entering a New Password



Enter the new password (4 to 12 digits) and then press the [*] button.

Warning

- To prevent an intrusion, it is recommended to make a password with 6 or more digits (from 0 to 9 can be set).
- Manage your password with care so that unauthorized people will not have access to it. Regularly changing your password can reduce the risk of it being leaked.
- A registered password cannot be deleted. Register a new password.

www.samsungsds-nss.com/en

PTSP22400NTA ED:01

Card and Key Tag Registration

When a new card or key tag is registered, those already registered are not deleted but additionally registered. If you do not want to register the existing card, delete all cards and register a new card. Up to 20 cards, including the key tag, can be registered.(Only ISO14443 A Type is available.)

1. Pressing the [Register] Button 2. Entering the Password



Success:
DING DONG DENG
→ DING DING
Fail:
DING DONG DING DONG

Open the battery cover of the inner body and briefly press the [Register] button.

When the number pad is lighted, enter the password and then press the [*] button.

3. Placing the Card or Key Tag on the Card Reader



4. Registration Done



To terminate registration, press the [Registration] button.

Warning

- To register multiple cards or key tags, lightly place another card or key tag on the card reader within 20 seconds after registering the previous card or key tag.
- To make sure the card and key tag has been properly registered, and close the door.
- Please, be aware that the only provided card and key tag by Samsung SDS Co. Ltd. shall work properly on the regular use for this door lock.

Welcome Mode

The Welcome mode is a convenient function that automatically activates the authorization standby mode when a user approaches the door, even before touching the number pad.

Welcome mode on: The mode will automatically activate the authorization standby mode when a user approaches the door lock.

Welcome mode off: The mode will activate the authorization standby mode when user touches the number pad.

One-minute alarm function on / off: When someone remains in front of the door lock for more than a minute, this mode will sound the tamper prevention alarm.

Warning

- The factory defaults are set with the welcome mode on and the one-minute alarm function off.
- The working distance of the infrared sensor can differ depending on light conditions and other environments. When the front door is exposed to sun light or constant bright lights it is advised to limit the usage of the sensor as it might sound the alarm.

Opening the Door from Outside with a Password

When purchased, the product is set to Randomizer mode initially.

1. Randomizer Mode

When approached the door lock (When applying the "welcome function") or if the number pad is touched, a lighting will appear on the number pad.



When two Random buttons are lighted, press the buttons in order.



When the numbers on the number pad are lighted, enter the password and press the [*] button.

2. Common Mode

When approached the door lock (When applying the "welcome function") or if the number pad is touched, a lighting will appear on the number pad.



Success:
DING DONG DENG DONG
Fail:
DING DONG DING DONG

Enter the password when the number pad is lighted, and press the [*] button.

※ Silent Mode

Before entering the password, press the [*] button and enter the password, then both the sound of the key entering and the door opening will be suspended. It is a useful function if you do not want to disturb neighbors when you go in and out at night.

Note

- Password must be entered after the light is on, and if does not, touch [Number Pad] and re-enter.
- To cancel, press [⏻] button and re-enter.
- If the password is wrong 5 times, "peep" warning alarm will sound 20 times and the system will shut-down for about 3 minutes. When malfunction happens, "beep" will sound every 10 seconds, and stop mode will be turned off automatically after 3 minutes with multiple 'beeps'.

Opening the Door from Outside with a Card or Key Tag

The door can be opened from outside using a card or key tag. Place the registered card or key tag on the card reader.

Placing the Card or Key Tag on the Card Reader



Success:
DING DONG DENG DONG
Fail:
DING DONG DING DONG

Place the card or key tag on the card reader. The door will be opened after 1 second.

Note

- When the welcome function is deactivated, touch the number pad and place the card to open the door.

Double Security

Double Security mode requires both card and password to open the door, ensuring more security. To setup the Double Security mode, more than 1 card must be registered.



Touching [Number Pad].



Enter the password when the number pad is lighted, and press the [*] button.

Success:
DING DONG DENG
Fail:
DING DONG DING DONG



Place the card on to the [Card Reader]. If the authentication is successful, the door will open.

Success:
DING DONG DENG DONG
Fail:
DING DONG DING DONG

Warning

- Take your card when going out after the Double Security mode is set. You cannot open the door if there is no card.

Opening the Door from the Inside

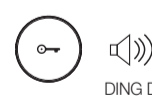

OR
DING DONG DENG DONG

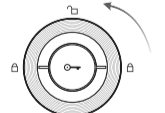

When the door is locked, press the [OPEN] button on the Inner Body to open the door.

When the door is locked, turn the [Manual knob] in the direction of [↻] to open the door.

Closing the Door from the Inside

Automatic Locking Setting

The door is automatically locked 1 seconds after the door is closed.

Manual Locking Setting

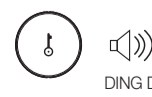

OR
DING DONG DENG DONG



When the door is locked, press the [OPEN] button on the Inner Body to open the door.

When the door is locked, turn the [Manual knob] in the direction of [↻] to lock the door.

At-home Security

At-home security mode is to prevent opening of the door from outside while someone is inside.



Press the [Number Pad] or touch with a card, then the sound for action unavailable will be heard.

At-home security Mode Activation



While the door is locked, press [OPEN] button on the inner body or press the [OPEN] button on the inner body part for 3 seconds.

At-home security Mode Deactivation



Briefly press the [OPEN] button on the inner body to release it or set the manual locking switch to [] and open the door to release it.

Warning When the At-home security mode is activated, the door cannot be unlocked from the outside, so please be careful. Be especially careful not to allow children to set this mode accidentally from the inside.

Deleting Registered Cards

You can delete all registered cards.

1. Pressing the [Register] Button



Open the battery cover of the inner body and press the [Register] button for 3 seconds.

2. Entering the Password

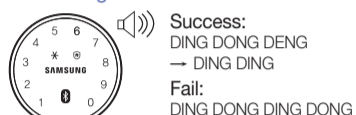

When the number pad is lighted, enter the password and then press the [*] button.

3. Entering the Number

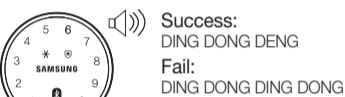

Enter the '88' and then press the [*] button.

Initialization (Password, Bluetooth, Card, Key Tag)

All registered data (password, Bluetooth, card, key tag) are deleted. After initialization, the password is set to '1234', and the registered card, key tag, Bluetooth data are erased. Please change password as a new one after initialization.

Pressing the [Register] Button



Open the battery cover of the inner body and press the [Register] button for 5 seconds.

Entering the Numbers for Initialization



When the number pad is lighted, enter '4567890123' and then press the [*] button.

[Settings] ※ All settings operate only when the door opens.

Bluetooth Mode

After the Bluetooth mode is activated, can authenticate the registered Bluetooth smartphone to open the door. The Bluetooth mode is activated by default.



Open the battery cover of the inner body and briefly press the [Register] button.

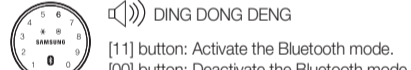

Enter [11] or [00] and then press the [*] button to activate or deactivate the Bluetooth mode.

Welcome Mode

The welcome function is a convenient function that automatically activates the authorization standby mode when a user approaches the door, even before touching the number pad.



Open the battery cover of the inner body and briefly press the [Register] button.

[1]+[*] button: Welcome function on, the one-minute alarm function on
[2]+[*] button: Welcome function on, the one-minute alarm function off
[3]+[*] button: Welcome function off

Randomizer Mode

Press two random button before enter the password.



Open the battery cover of the inner body and briefly press the [Register] button.

Press the [*] button after pressing [7] or [9] button, and the security mode will be set.

Double Authorization Mode

Double authorization mode requires both card and password to open the door, ensuring more security. To setup the double authorization mode, more than 1 card must be registered.



Open the battery cover of the inner body and briefly press the [Register] button.

Press the [*] button after pressing the [4] or [6] button, and the double authorization mode will be set.

Set up Instructions for Alarm functions

This is a basic function of the lock when a user goes out. This function generates the alarm sound when an attempt is made to forcefully open the door from the inside. In the alarm function, if someone tries to open the door from the inside, 'beep- beep-' sound is generated for 5 minute

Set up the Alarm function

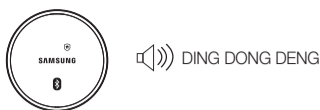

When the door is closed, user can set up the alarm function by pressing and holding the [] button for 3 seconds until sound confirmation.

Release the Alarm function



Place the registered card or key tag on the card reader, or enter the password and then press the [*] button.

Prank Prevention

This function generates an alarm sound and deactivates lock operation when it is improperly handled from the outside.

This alarm will sound if an attempt is made to open the door with an invalid card, or if a wrong password is entered five times in a row. The alarm sound is generated, and the lock is deactivated for 3 minutes. While the door is in this inactive mode, a single "DING" sound is generated every 10 seconds and seven consecutive "DINGS" will sound after 3 minutes. Following this, the lock is released from inactive mode.

Releasing the alarm sound or emergency sound

This function releases an alarm sound or emergency sound

Inside



Open the battery cover of the inner body and then press the [Register] button or take out batteries.

Outside



Place the registered card or key tag on the card reader, or enter the password and then press the [*] button.

High temperature Detection

This function generates the alarm sound when fire is detected so that the residence can quickly respond.

High temperature Detection is operational at about 70°C±10°C ; this can vary depending on the installation environment. When a fire breaks out, the temperature sensor detects it. The LED of the [OPEN] button on the inner body flashes while the alarm sound is generated for 15 seconds. After the alarm sound stops, the door is automatically opened. (The lock resumes normal operation if the inside temperature returns to a normal level.)

※ The High temperature Detection is a basic function of the lock, and cannot be released by the user.

Automatic/Manual Locking

The Automatic Locking mode allows for automatic locking of the door when it is closed.



Open the battery cover of the inner body and briefly press the [Register] button.

[21] + [*] Button: Automatic Locking
[22] + [*] Button: Manual Locking

Automatic Locking: The door is automatically locked 1 seconds after being closed. This mode is not activated when the batteries are completely discharged.

Manual Locking: The door does not lock automatically, and [OPEN] button must be pressed from the inside, touch [Number Pad] to close the door.

Warning Regardless of the Automatic/Manual locking setting, If the door is not open after unlocked the door, the door will lock automatically after 7 seconds.

Door Lock Time Setup

This function sets the time interval between the moment the open-door sensor recognizes the door as closed and the moment deadbolt locks the door. In an environment that the door closes slowly and the deadbolt jams before the door is fully closed, the situation can be fixed by adjusting the door lock time.



Open the battery cover of the inner body and briefly press the [Register] button.

Enter [51] ~ [59] button, and then press [*] button.

Sound Setting and Releasing

The sound that is generated when the number buttons are pressed, when the door is locked or when the locked door is unlocked, can be set according to the user's preference. The product is set to generate all sounds at the factory. (Set in 1 Step)



Open the battery cover of the inner body and briefly press the [Register] button.

[31] + [*] buttons: The sound of door opening/closing and key entering is not generated (except an alarm sound).
[32] + [*] Button: 1 Step
[33] + [*] Button: 2 Step

Replacing the Batteries

Battery Replacement Alarm Generation

If the melody of "Blues for Elise" sounds when opening the door with the password or a card (key tag), it is time to replace the batteries. (The low battery indicator () is lighted when the melody sounds.)

Replacing the Battery

- After put up a battery holder, insert two batteries in the lower section.
- After put down a battery holder, insert two batteries in the upper section.

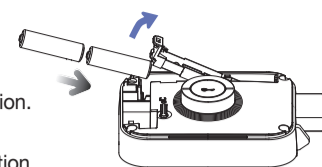

AA Alkaline Batteries X 4EA

Warning Depending on battery manufacturer, date of manufacture and the user environment, the duration of use may vary. (In the case of average use, given as 10 times a day with a wireless module not mounted, 4 AA Alkaline 1.5V batteries can last for 10 months.)
Liquid leaks from batteries can damage the product. Check the batteries regularly (every 6 months).
After the battery replacement alarm has sounded, password/card (key tag) information cannot be registered, changed, deleted, initialized or configured until the batteries are replaced.

Using the Emergency Battery

If the batteries are not replaced after their replacement time comes, they will be completely discharged and the lock will not operate.

Opening the Door Using an Emergency Battery

Purchase an emergency battery (9V) at the nearest store. As the alkaline batteries offer longer life, they are recommended over the manganese batteries or rechargeable ones.

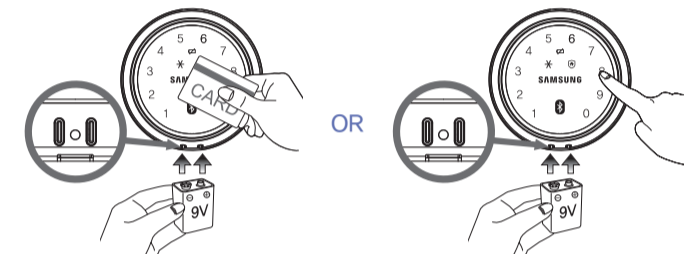

While contacting a 9V battery to the external power (emergency battery) contact on the outer body for 2 seconds or longer, place the card or key tag or enter the password.

Product Specifications

Item	Specifications
Voltage	AA Alkaline 1.5V Batteries (LR6) 4EA (6V)
Emergency Power Source	9V Battery (6LF22) (Separately sold)
Operation Method	Electronic Control Method (Password entry or card or key tag reading or bluetooth)
Weight	0.8 kg (including both inner and outer bodies)
Product Dimensions	Outer Body 82.8mm(D) x 19mm(H)
	Inner Body 140mm(W) x 106mm(L) x 44mm(H)

• The contents of this user guide are subject to change without prior notice to the user in order to enhance performance of the product.

Safety Cautions

Warning This section contains important information to ensure the user's safety and prevent potential damage to property. Please, read this section carefully and use the product accordingly.

- The user shall not install or repair the product without authorization.
- Do not install the product in the place where the gap between the door and the frame is 5mm or more.
- Make sure that no unauthorized person has the access to the password.
- Do not operate the product with wet hands, and keep liquids such as water or drinks away from the product, or the product may malfunction or be damaged.
- Do not use the excessive force or sharp objects to push the lockbuttons, as this can damage the product.
- Make sure that the door is completely closed when going outside. The manufacturer does not assume the responsibility for any harm caused by engagement of the lock on an improperly closed door.
- Long-term exposure to direct sunlight may cause a crack on its touch pad. Avoid exposure to direct sunlight during installation.
- Be sure to correctly match the poles (+/-) when installing the batteries. Install the batteries with the correct poles (+/-).
- Do not use water, benzene or alcohol when cleaning the product, as these fluids can cause product malfunction.
- Replace the batteries immediately after the battery replacement alarm sounds.
- Interference in wireless communication may occur when this product is used.
- According to the wireless communication environment, its battery may consume much.
- During battery replacement, use a new one instead of the existing battery.

Caution

This product is a keyless door lock. Thus, if it does not work, you can damage a part of the door lock. You need to fully understand how to use the manual locking switch to prepare for an emergency.