

*xdobo*

Upgraded

# X8 II

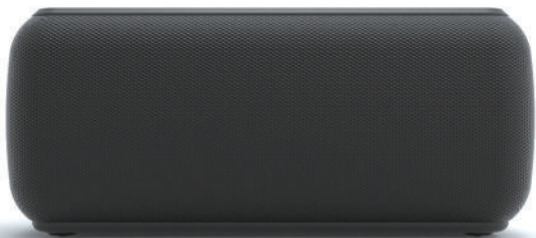

— MANUAL —

# X8 II

## Quick Start Guide

---

### 1 / Warning

- \* Do not use any fast charger or PD charger or GaN charger or quick charger exceed 5V-2A output.
- \* XODOBO X8 is IPX5 waterproof. Do not expose XODOBO X8 to water while charging.
- \* As doing so may result in permanent damage to the speaker or power source.

### 2 / What is TWS?

TWS means true wireless stereo. Let's say two Bluetooth speaker are able to be paired and playing music synchronously.







How to pair your device?

- 1: Please make sure these two speakers to be paired disconnect from your Bluetooth device before you turn them on. Then please turn on two speakers.
- 2: Select either of the speaker. Double click "power" button to enter TWS status.
- 3: When successfully paired, The LED indication light on either speaker will stay yellow, and the other speaker will flash blue.
- 4: Find X8 on your device, select it and connect.
- 5: Once the speakers are well paired at the first time, they will be automatically paired next time without the above pairing operation.
- 6: If the speaker used to be paired, it is suggested to press "voice" button for 5 seconds to forcibly cut off the power. Then restart and have same speaker re-paired with required new speaker according to the above instruction item 1- item 4.
- 7: When speakers are paired, only the "master" speaker will answer the phone.
- 8: EQ (M button) sound effects can be used when TWS mode.

# X8 II

## Quick Start Guide

### 3 / Function key

Key	Operation	Instruction
	Short press	Turn on
	Long press	Turn off
	Double click	Double-click the button to enter the TWS mode.
	Short press	Mode change: BT-TF-AUX
	Long press	Sound change: Bass-Vocal-Full frequency
	Short press	1:Play /Stop 2:Answer calls/Hang up 3:Quick double click to dial the last number
	Long press	Disconnected/ reject answering
	Short press	Volume down, 16 degrees in total
	Long press	Previous track
	Short press	Volume up, 16 degrees in total
	Long press	Next Track
	Short press	Turn on the phone voice assistant feature
	Long press	Restart

# X8 II

Quick Start Guide



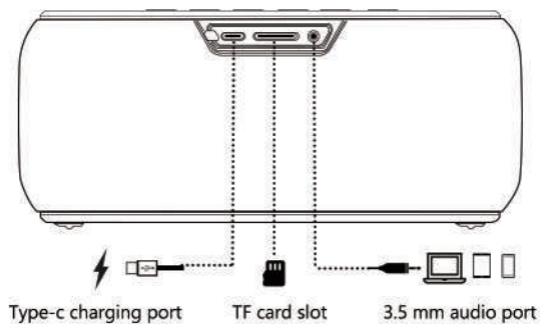
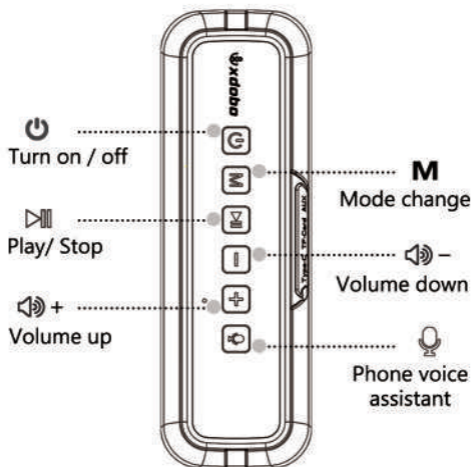



## 4/Overview



# X8 II

## Quick Start Guide

### 5/LED indication

Status	LED indication
 Pairing mode	 Fast blinking
 Bluetooth connected	 On
 TF card / Aux play	 On
 Charging	 OFF
 Super bass	 On
 Vocal	  On
 Full frequency	   On
 Full Charged	 OFF
 TWS Mode	 Fast blinking

### 6/Bluetooth pairing

When speaker is powered on, the blue LED will blink. Find "X8" on your device and select to pair.

## 7 / Specifications

- Bluetooth version:5.0
- Output Power:60W RMS
- Frequency response:80hz-18kHz
- Signal-to-noise ratio:80±2dB
- Battery type:3.7V/6600mAh
- Battery charge time:about 3 hours
- Input Power: Type-c 5V / 2A
- Music playing time:up to 8 hours(varies by volume level and audio content)
- Dimensions(H×W×D):220×95×72(mm)/8.7"×3.7" ×2.8"
- Weight: 860g / 1.9 lbs

## 8 / Performance optimization

\*The speaker usage time will vary depending on the volume and song.

\*Playing loudest and playing heavy bass songs will speed up battery consumption.

(1) When the X8 is tuned to the maximum sound, it will protect the speaker components, including the optimization of battery durability and playback time.

(2)That is, in order to play longer and reduce battery consumption, the balance of the tone will be adjusted appropriately, including the adjustment of the bass, treble and vocal parts.

(3)Therefore, the loudest and medium-volume heavy bass levels are different.

\*XDOBO recommends that the X8 be adjusted to a medium volume for listening, this will maintain the best sound and battery performance.

*xdobo*

升级版

# X8 II



— MANUAL —

# X8 II

## Quick Start Guide

### 1 / 警告

\*喜多宝X8具有5级防水。不要把插口暴露在水中充电。

\*不能使用任何种类超过5V-2A的快充，如PD快充，手机快充头，高通快充，氮化镓快充等。这些充电头的电压不能被主板识别和兼容。

\*以上两种操作，如果执行下去会损坏喇叭或烧坏电路板，造成永久损坏，不能继续充电。

### 2 / TWS串联功能

TWS 的意思是两台音箱无线串联，形成环绕立体音。  
怎么配对？

1:将两台音箱开机（如果有其他设备连接，必须先断开音箱与其他设备的连接）；

2:双击其中一台音箱“POWER”键，即进入TWS配对模式；

3:TWS配对成功并有提示音，两台黄灯变长亮；

4:此时打开蓝牙设备（手机）的蓝牙功能，会搜索到一个蓝牙设备名为X8，并连接；

5:TWS配对成功的机器，以后每次开机即可自动快速TWS配对连接；

6:如果机器曾经有配对过TWS的，建议开机后首先长按5秒“Voice”键（恢复出厂设置）并重启机器后，再参照以上1-3操作即可TWS配对成功；

7:在TWS模式下通话时只有主音箱有免提功能，副音箱为无声；







8:在TWS模式下，EQ（M 键）音效可以使用。



# X8 II

## Quick Start Guide

### 3 / 按键功能

按键	操作	功能说明
	短按	音箱开机，进入蓝牙模式，等待设备连接
	长按	音箱关机
	双击	音箱开机未连接其他设备，双击“POWER”键可以进入TWS串联模式
	短按	短按一下“MODE”键可以切换：蓝牙、TF卡、AUX音频连接模式
	长按	音效模式转换：重低音-人声-全频
	短按	1.音乐播放状态下，短按可以播放/暂停音乐； 2.在来电的状态时，短按可以接通电话； 3.在已接听电话时，短按可以挂断电话； 4. 蓝牙已连接手机的状态下：双击“PLAY/PAUSE”键，可以回拨手机最后拨出的电话
	长按	1.在来电的状态下：长按“PLAY或PAUSE”键2s可以拒绝电话； 2.在蓝牙连接状态下，长按“PLAY或PAUSE”键2S可以断开蓝牙连接。
	短按	音量减小，共16级。
	长按	切换至上一首歌曲。
	短按	音量增大，共16级。
	长按	切换至下一首歌曲。
	短按	短按一下“Voice”键唤醒语音助手功能。
	长按	重启

# X8 II

Quick Start Guide

## 4/Overview

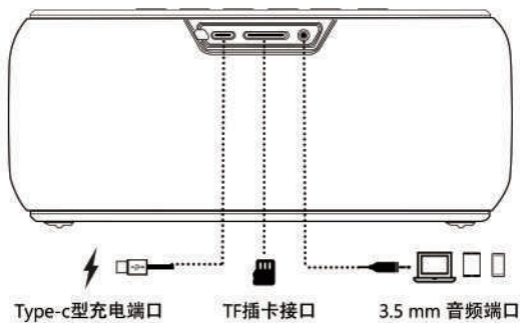
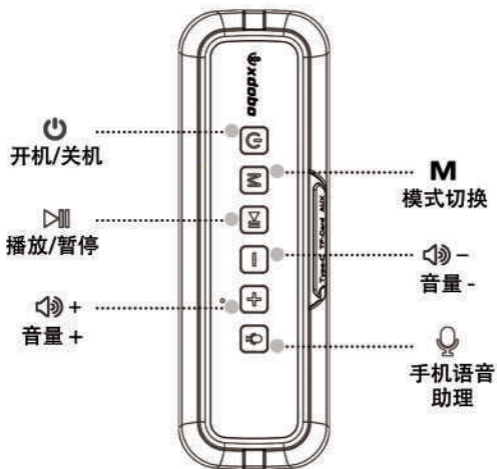

# X8 II

## Quick Start Guide

### 5 / 指示灯

音箱状态	指示灯状态
 音箱连接中	 闪烁
 音箱连接成功	 常亮
 TF 卡 / 音频播放中	 常亮
 充电中	 熄灭
 重低音	 常亮
 人声	 常亮
 全频	 常亮
 充满电	 熄灭
 TWS串联状态中	 闪烁

### 6 / 蓝牙连接

音箱打开，蓝灯会闪烁。

在你的设备上找到“X8”蓝牙名字，然后选择配对。

# X8 II

## Quick Start Guide

### 7 / 产品参数

- 蓝牙版本：5.0
- 输出功率：60瓦
- 有效频宽：80hz-18kHz
- 输出声压水平：80±2dB
- 电池规格：3.7V/6600mah
- 充电时间：约3小时
- 输入电源：Type-c 5V/2A
- 播放时间：大于8小时（根据音量大小有所不同）
- 尺寸：(长×宽×高) 220×95×72(mm)/8.7"×3.7"×2.8"
- 重量：860克 / 1.9磅

### 8 / 性能优化

\*音箱使用时间会根据音量和歌曲的不同而有所不同。

\*最大声播放和播放重低音歌曲将会加快电量的消耗。

\*喜多宝X8调到最大音时，会对音箱部件做出保护，包括对电池的耐久性和播放时间的优化。

即为了播放时间更长，降低电池的损耗，会适当地调整音色的均衡，包括低音，高音和人声部分的调整。因此，最大声和中等音量的重低音程度有所不同。

\*喜多宝建议把X8调到中等音量聆听，这样做将会保持最佳音色和电量性能。



# 产品保修卡

生产企业：深圳喜多宝电子有限公司

企业地址：深圳市龙华新区龙城工业区C栋

邮政编码：518110

# 合格证

QUALIFIED CERTIFICATE

型号： \_\_\_\_\_  
(MODEL)

检验员： \_\_\_\_\_  
(CHECKER)



出厂日期： \_\_\_\_\_  
(DATE)

## 产品保修卡

用户档案 \_\_\_\_\_年\_\_月\_\_日

用户姓名	
通讯地址	
联系电话	
产品型号	
产品问题	

### 保修条款

- \*非特别标注,用户购买之日起, 所有产品因自身品质问题(非产品软件故障),用户可选择的退货期限为7日,换货期限为15日,保修期限为12月;
- \*用户遇到产品质量问题, 均可向我司制定的服务部要求提供三包服务。如需要运费, 客户自行承担运送等相关费用;
- \*用户要求三包服务时, 需主动提供此有效的保障服务凭证及发票;
- \*超出产品三包服务的额外服务, 需按照相关的规定收取费用, 收费维修后的产品保修期限为自取件之日或发货之日起3个月;
- \*我司提供的三包服务, 仅限于出现品质问题的产品, 不包括赔偿购买者的利益损失, 意外情况导致的损失以及其他任何间接或直接的损失;
- \*用户应主动在购买的销售处按照要求填写此凭证, 我司不承担因为未按要求填写凭证带来的后果, 也不承担销售商对用户超出保修服务条例以外的承诺。

*xdobo*

Mis à jour

# X8 II



— MANUAL —

# X8 II

## Quick Start Guide

---

### 1 / Attention

\* N'utilisez pas de chargeur rapide ou de chargeur PD ou de chargeur GaN ou de charge rapide excédant la sortie 5V-2A.

\* XODOBO X8 est étanche IPX5. N'exposez pas le XODOBO X8 à l'eau pendant le chargement.

\* Cela pourrait entraîner des dommages permanents au haut-parleur ou à la source d'alimentation.

### 2 / Qu'est-ce que TWS?

TWS signifie véritable stéréo sans fil. Supposons que deux haut-parleurs Bluetooth puissent être associés et lire de la musique de manière synchrone.

Comment coupler votre appareil?

1: Veuillez vous assurer que ces deux enceintes à coupler se déconnectent de votre appareil Bluetooth avant de les allumer. Veuillez ensuite allumer deux haut-parleurs.

2: Sélectionnez l'une des enceintes. Double-cliquez sur le bouton «power» pour entrer dans l'état TWS.

3: Une fois le couplage réussi, le voyant LED de l'une des enceintes restera jaune et l'autre haut-parleur clignotera en bleu.

4: Trouvez X8 sur votre appareil, sélectionnez-le et connectez-vous.

5: Une fois que les haut-parleurs sont bien couplés la première fois, ils seront automatiquement couplés la prochaine fois sans l'opération de couplage ci-dessus.

6: Si l'enceinte était jumelée, il est suggéré d'appuyer sur le bouton «voix» pendant 5 secondes pour couper l'alimentation de force. Ensuite, redémarrez et faites réappairer le même haut-parleur avec le nouveau haut-parleur requis conformément au point d'instruction 1 ci-dessus, élément 4.

7: Lorsque les haut-parleurs sont appairés, seul le haut-parleur «principal» répondra au téléphone.







8: Les effets sonores EQ (bouton M) peuvent être utilisés en mode TWS.



# X8 II

## Quick Start Guide

### 3 / Clé de fonction

Clé	Opération	Instruction
	Presse courte	Allumer
	Appui long	Éteindre
	Double clic	Double-cliquez sur le bouton pour accéder au mode TWS.
	Presse courte	Changement de mode: BT-TF-AUX
	Appui long	Changement de son: Fréquence Bass-Vocal-Full
	Presse courte	1: lecture / arrêt 2: Répondre aux appels / Raccrocher 3: double-clic rapide pour composer le dernier numéro
	Appui long	Déconnecté / rejeter la réponse
	Presse courte	Baisser le volume, 16 degrés au total
	Appui long	Piste précédente
	Presse courte	Augmentation du volume, 16 degrés au total
	Appui long	Next Track
	Presse courte	Activer la voix du téléphone fonction assistant
	Appui long	Redémarrer

# X8 II

Quick Start Guide



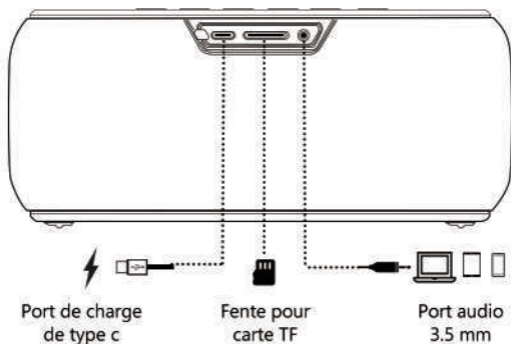
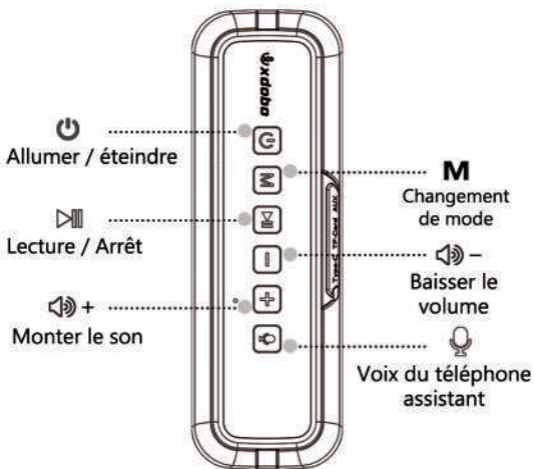

















## 4/Aperçu



# X8 II

## Quick Start Guide

### 5/ Indication LED

Statut	Indication LED
 Mode d'appariement	 Clignotement rapide
 Bluetooth connecté	 Sur
 Carte TF / Lecture Aux	 Sur
 Mise en charge	 DE
 Super basse	 Sur
 Vocal	  Sur
 Fréquence complète	   Sur
 Complètement chargé	 DE
 Mode TWS	 Clignotement rapide

### 6/ Couplage Bluetooth

Lorsque le haut-parleur est sous tension, le voyant bleu clignote.

Recherchez «X8» sur votre appareil et sélectionnez pour le coupler.

# X8 II

## Quick Start Guide

---

### 7 / Caractéristiques

- Version Bluetooth: 5.0
- Puissance de sortie: 60 W RMS
- Réponse en fréquence: 80hz-18kHz
- Rapport signal / bruit: 80 ± 2 dB
- Type de batterie: 3.7 V / 6600 mAh
- Temps de charge de la batterie: environ 3 heures
- Puissance d'entrée: Type-c 5V/2A
- Durée de lecture de la musique: jusqu'à 8 heures (varie selon le niveau de volume et le contenu audio)
- Dimensions(H×L×P):220×95×72(mm)/8.7"×3.7"×2.8"
- Poids: 860g/1.9lbs

### 8 / Performance optimization

\* La durée d'utilisation du haut-parleur varie en fonction du volume et de la chanson.

\* La lecture des morceaux les plus forts et la lecture des morceaux de basse intense accélèrent la consommation de la batterie.

(1) Lorsque le X8 est réglé sur le son maximum, il protégera les composants du haut-parleur, y compris l'optimisation de la durabilité de la batterie et de la durée de lecture.

(2) Autrement dit, afin de jouer plus longtemps et de réduire la consommation de la batterie, l'équilibre de la tonalité sera ajusté de manière appropriée, y compris le réglage des parties graves, aiguës et vocales.

(3) Par conséquent, les niveaux de graves lourds les plus forts et les volumes moyens sont différents.

\* XDOBO recommande que le X8 soit ajusté à un volume moyen pour l'écoute, cela maintiendra le meilleur son et les meilleures performances de la batterie.

*xdobo*

Actualizado

# X8 II



— MANUAL —

# X8 II

Quick Start Guide

## 1 / Advertencia

- \* No use ningún cargador rápido o cargador PD o cargador GaN o la carga rápida exceda la salida de 5V-2A.
- \* XODOBO X8 es resistente al agua IPX5. No exponga el XODOBO X8 al agua durante la carga.
- \* Si lo hace, puede provocar daños permanentes en el altavoz o la fuente de alimentación.

## 2 / ¿Qué es TWS?

TWS significa verdadero estéreo inalámbrico. Supongamos que se pueden emparejar dos altavoces Bluetooth y reproducir música de forma sincrónica.



¿Cómo emparejar su dispositivo?

- 1: asegúrese de que estos dos altavoces para emparejar se desconecten de su dispositivo Bluetooth antes de encenderlos. Luego, encienda dos altavoces.
- 2: Seleccione cualquiera de los altavoces. Haga doble clic en el botón de "encendido" para ingresar al estado de TWS.
- 3: Cuando se empareja correctamente, la luz indicadora LED en cualquiera de los altavoces permanecerá amarilla y el otro altavoz parpadeará en azul.
- 4: Busque X8 en su dispositivo, selecciónelo y conéctese.
- 5: Una vez que los altavoces estén bien emparejados por primera vez, se emparejarán automáticamente la próxima vez sin la operación de emparejamiento anterior.
- 6: Si el altavoz solía estar emparejado, se sugiere presionar el botón de "voz" durante 5 segundos para cortar la alimentación por la fuerza. Luego reinicie y vuelva a emparejar el mismo altavoz con el nuevo altavoz requerido de acuerdo con la instrucción anterior, punto 1, punto 4.
- 7: Cuando los altavoces están emparejados, solo el altavoz "maestro" contestará el teléfono.
- 8: Los efectos de sonido EQ (botón M) se pueden usar en el modo TWS.

# X8 II

## Quick Start Guide

### 3 / Tecla de función

Llave	Operación	Instrucción
	Pulsación corta	Encender
	Pulsación larga	Apagar
	Haga doble clic	Haga doble clic en el botón para ingrese al modo TWS.
<b>M</b>	Pulsación corta	Cambio de modo: BT-TF-AUX
	Pulsación larga	Cambio de sonido: Bass-Vocal-Full frecuencia
	Pulsación corta	1: Reproducir / Detener 2: responder llamadas / colgar 3: doble clic rápido para marcar el ultimo numero
	Pulsación larga	Desconectado / rechazar respuesta
<b>-</b>	Pulsación corta	Bajar volumen, 16 grados en total
	Pulsación larga	Pista anterior
<b>+</b>	Pulsación corta	Subir volumen, 16 grados en total
	Pulsación larga	Siguiente pista
	Pulsación corta	Enciende la voz del teléfono función asistente
	Pulsación larga	Reiniciar

# X8 II

Quick Start Guide

## 4 / Visión general

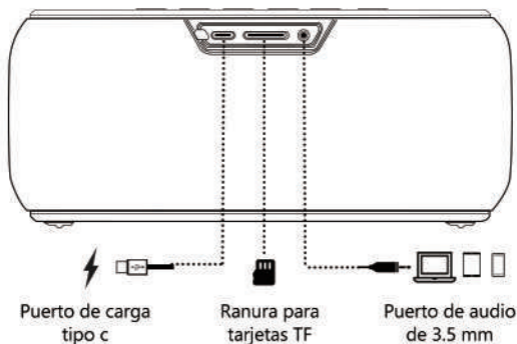
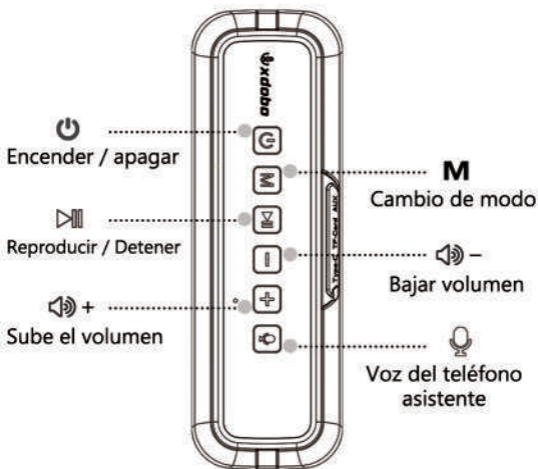



# X8 II

## Quick Start Guide

### 5/Indicación LED

Estado	Indicación LED
 Modo de emparejamiento	 Parpadeo rápido
 Bluetooth conectado	 On
 Tarjeta TF / juego auxiliar	 On
 Cargando	 OFF
 Súper bajo	 On
 Vocal	  On
 Frecuencia completa	   On
 Completamente cargado	 OFF
 Modo TWS	 Parpadeo rápido

### 6/Emparejamiento bluetooth

Cuando el altavoz está encendido, el LED azul parpadeará. Busque "X8" en su dispositivo y seleccione emparejar.

# X8 II

Quick Start Guide

---

## 7 / Especificaciones

- Versión de Bluetooth: 5.0
- Power Potencia de salida: 60W RMS
- Respuesta de frecuencia: 80hz-18kHz
- Relación señal / ruido:  $80 \pm 2$ dB
- Tipo de batería: 3.7V / 6600mAh
- Tiempo de carga de la batería: aproximadamente 3 horas.
- Energía de entrada: Tipo-c 5V / 2A
- Time Tiempo de reproducción de música: hasta 8 horas (varía según el volumen nivel y contenido de audio)
- Dimensiones(H×W×D): 220×95×72(mm)/8.7"×3.7"×2.8"
- Peso: 860g / 1.9 lbs

## 8 / Optimización del rendimiento

\* El tiempo de uso de los altavoces variará según el volumen y la canción.

\* Tocar más alto y tocar canciones de bajo peso acelerará el consumo de batería.

(1) Cuando el X8 está sintonizado al máximo de sonido, protegerá los componentes del altavoz, incluida la optimización de la duración de la batería y el tiempo de reproducción.

(2) Es decir, para tocar durante más tiempo y reducir el consumo de batería, el equilibrio del tono se ajustará adecuadamente, incluido el ajuste de las partes de graves, agudos y vocales.

(3) Por lo tanto, los niveles de graves pesados más altos y de volumen medio son diferentes.

\* XDOBO recomienda que el X8 se ajuste a un volumen medio para escuchar, esto mantendrá el mejor sonido y rendimiento de la batería.

*xdobo*

Aktualisiert

# X8 II



— MANUAL —

# X8 II

## Quick Start Guide

---

### 1 / Warnung

- \* Verwenden Sie kein Schnellladegerät oder PD-Ladegerät oder GaN-Ladegerät oder Schnellladegerät mit einer Ausgangsleistung von mehr als 5 V bis 2 A.
- \* XODOBO X8 ist IPX5 wasserdicht. Setzen Sie XODOBO X8 während des Ladevorgangs keinem Wasser aus.
- \* Dies kann zu dauerhaften Schäden am Lautsprecher oder an der Stromquelle führen.

### 2 / Was ist TWS?

TWS bedeutet echte drahtlose Stereoanlage. Angenommen, zwei Bluetooth-Lautsprecher können gekoppelt werden und synchron Musik abspielen.







Wie kopple ich mein Gerät?

- 1: Stellen Sie sicher, dass diese beiden zu koppelnden Lautsprecher nicht mit Ihrem Bluetooth-Gerät verbunden sind, bevor Sie sie einschalten. Dann schalten Sie bitte zwei Lautsprecher ein.
- 2: Wählen Sie einen der Lautsprecher aus. Doppelklicken Sie auf die Ein- / Aus-Taste, um den TWS-Status einzugeben.
- 3: Nach erfolgreicher Kopplung bleibt die LED-Anzeigelampe an einem der Lautsprecher gelb und der andere Lautsprecher blinkt blau.
- 4: Suchen Sie X8 auf Ihrem Gerät, wählen Sie es aus und stellen Sie eine Verbindung her.
- 5: Sobald die Lautsprecher beim ersten Mal gut gekoppelt sind, werden sie beim nächsten Mal automatisch ohne die oben beschriebene Kopplungsoperation gekoppelt.
- 6: Wenn der Lautsprecher früher gekoppelt war, wird empfohlen, die „Voice“ -Taste 5 Sekunden lang zu drücken, um die Stromversorgung gewaltsam zu unterbrechen. Starten Sie dann neu und lassen Sie denselben Lautsprecher gemäß der obigen Anweisung Punkt 1 - Punkt 4 erneut mit dem erforderlichen neuen Lautsprecher koppeln.
- 7: Wenn die Lautsprecher gekoppelt sind, geht nur der „Master“ -Lautsprecher ans Telefon.
- 8: EQ-Soundeffekte (M-Taste) können im TWS-Modus verwendet werden.

# X8 II

## Quick Start Guide

### 3 / Funktionstaste

Schlüssel	Operation	Anweisung
	Kurz drücken	Schalte ein
	Lange drücken	Ausschalten
	Doppelklick	Doppelklicken Sie auf die Schaltfläche zu Rufen Sie den TWS-Modus auf.
	Kurz drücken	Moduswechsel: BT-TF-AUX
	Lange drücken	Klangveränderung: Bass-Vocal-Full Frequenz
	Kurz drücken	1: Spielen / Stoppen 2: Anrufe entgegennehmen / Auflegen 3: Doppelklicken Sie zum Wählen die letzte Nummer
	Lange drücken	Antwort getrennt / ablehnen
	Kurz drücken	Lautstärke verringern, 16 Grad insgesamt
	Lange drücken	Vorheriges Lied
	Kurz drücken	Lautstärke erhöhen, 16 Grad insgesamt
	Lange drücken	Nächster Titel
	Kurz drücken	Aktivieren Sie die Sprachassistentenfunktion des Telefons
	Lange drücken	Neustart

# X8 II

Quick Start Guide

## 4 / Überblick

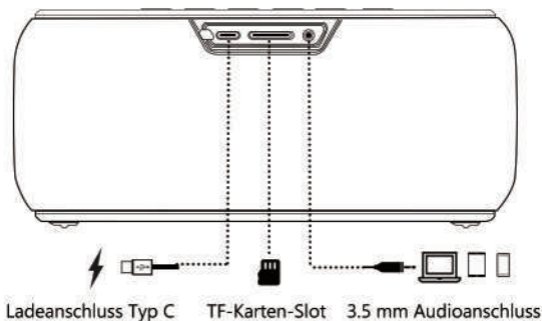
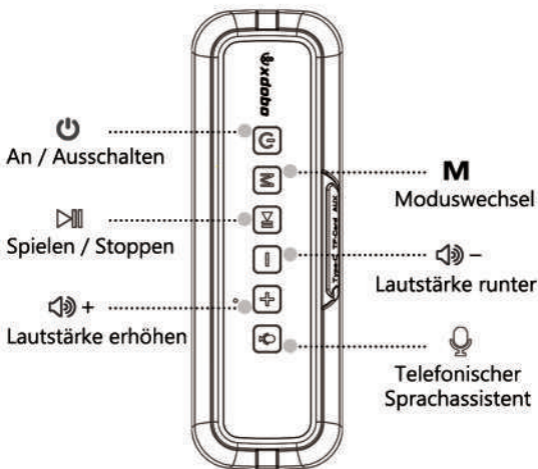

## 5 / LED-Anzeige

Status	LED-Anzeige
 Verbindungsmodus	 Schnelles Blinken
 Bluetooth verbunden	 Auf
 TF-Karte / Aux-Spiel	 Auf
 Aufladen	 AUS
 Super bass	 Auf
 Vokal	  Auf
 Volle Frequenz	   Auf
 Voll aufgeladen	 AUS
 TWS-Modus	 Schnelles Blinken

## 6 / Bluetooth-Kopplung

Wenn der Lautsprecher eingeschaltet ist, blinkt die blaue LED.

Suchen Sie auf Ihrem Gerät nach „X8“ und wählen Sie das Pairing aus.

## 7 / Spezifikationen

- Bluetooth-Version: 5.0
- Ausgangsleistung: 60 W RMS
- Frequenzgang: 80 Hz - 18 kHz
- Signal-Rausch-Verhältnis:  $80 \pm 2$  dB
- Batterietyp: 3.7 V / 6600 mAh
- Ladezeit des Akkus: ca. 3 Stunden
- Eingangsleistung: Typ C 5V / 2A
- Musikspielzeit: bis zu 8 Stunden (variiert je nach Lautstärke)
- Pegel und Audioinhalt) Abmessungen (H × B × T):  
220 × 95 × 72 (mm) / 8.7 " × 3.7 " × 2.8 "
- Gewicht: 860 g / 1.9 lbs

## 8 / Leistungsoptimierung

\* Die Nutzungsdauer der Lautsprecher hängt von der Lautstärke und dem Titel ab.

\* Wenn Sie am lautesten spielen und schwere Bass-Songs spielen, wird der Batterieverbrauch beschleunigt.

(1) Wenn der X8 auf den maximalen Klang eingestellt ist, werden die Lautsprecherkomponenten geschützt, einschließlich der Optimierung der Batterielebensdauer und der Wiedergabezeit.

(2) Das heißt, um länger zu spielen und den Batterieverbrauch zu reduzieren, wird die Klangbalance entsprechend angepasst, einschließlich der Einstellung der Bässe, Höhen und Gesangsteile.

(3) Daher sind die lautesten und mittelstarken schweren Basspegel unterschiedlich.

\* XDOBO empfiehlt, das X8 zum Hören auf eine mittlere Lautstärke einzustellen, um den besten Klang und die beste Akkuleistung zu erzielen.



*xdobo*

Aggiornato

# X8 II

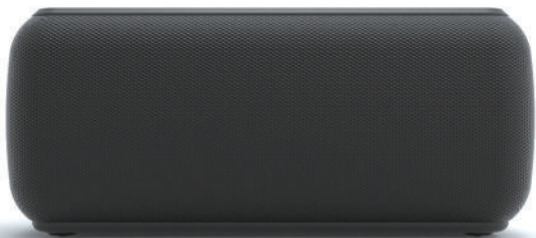

— MANUAL —

# X8 II

Quick Start Guide

## 1 / avvertimento

- \* Non utilizzare alcun caricatore rapido o caricatore PD o caricatore GaN o carica rapida oltre l'uscita 5V-2A.
- \* XODOBO X8 è impermeabile IPX5. Non esporre XODOBO X8 all'acqua durante la ricarica.
- \* Ciò potrebbe causare danni permanenti all'altoparlante o alla fonte di alimentazione.

## 2 / Cos'è TWS?

TWS significa vero stereo wireless. Supponiamo che due altoparlanti Bluetooth possano essere accoppiati e riprodurre musica in modo sincrono.







Come accoppiare il tuo dispositivo?

- 1: Assicurati che questi due altoparlanti siano accoppiati e scollegati dal tuo dispositivo Bluetooth prima di accenderli. Quindi accendi due altoparlanti.
- 2: selezionare uno degli altoparlanti. Fare doppio clic sul pulsante "accensione" per accedere allo stato TWS.
- 3: Una volta accoppiato con successo, la luce di indicazione del LED su uno degli altoparlanti rimarrà gialla e l'altro altoparlante lampeggerà in blu.
- 4: Trova X8 sul tuo dispositivo, selezionalo e connetti.
- 5: Una volta che gli altoparlanti sono ben accoppiati per la prima volta, verranno automaticamente accoppiati la volta successiva senza l'operazione di accoppiamento sopra.
- 6: Se l'altoparlante era accoppiato, si consiglia di premere il pulsante "voce" per 5 secondi per interrompere forzatamente l'alimentazione. Quindi riavviare e riaccoppiare lo stesso altoparlante con il nuovo altoparlante richiesto in base alle istruzioni di cui sopra 1 - articolo 4.
- 7: Quando gli altoparlanti sono accoppiati, solo l'altoparlante "principale" risponderà al telefono.
- 8: Gli effetti sonori EQ (pulsante M) possono essere utilizzati in modalità TWS.

# X8 II

## Quick Start Guide

### 3 / Tasto funzione

Chiave	Operazione	Istruzioni
	Pressione breve	Accendere
	Premere a lungo	Spegni
	Doppio click	Fare doppio clic sul pulsante per accedere alla modalità TWS.
	Pressione breve	Cambio di modalità: BT-TF-AUX
	Premere a lungo	Modifica del suono: Bass-Vocal-Full frequenza
	Pressione breve	1: Riproduci / Interrompi 2: rispondere alle chiamate / riagganciare 3: Doppio clic rapido sull'ultimo numero
	Premere a lungo	Disconnesso / rifiuta la risposta
	Pressione breve	Volume giù, 16 gradi in totale
	Premere a lungo	Traccia precedente
	Pressione breve	Volume su, 16 gradi in totale
	Premere a lungo	Prossima traccia
	Pressione breve	Attiva la funzione dell'assistente vocale del telefono
	Premere a lungo	Ricomincia

# X8 II

Quick Start Guide

## 4/Panoramica

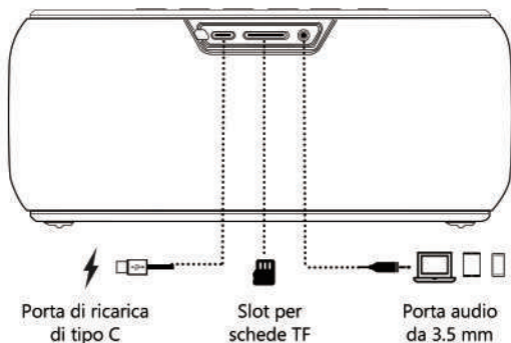
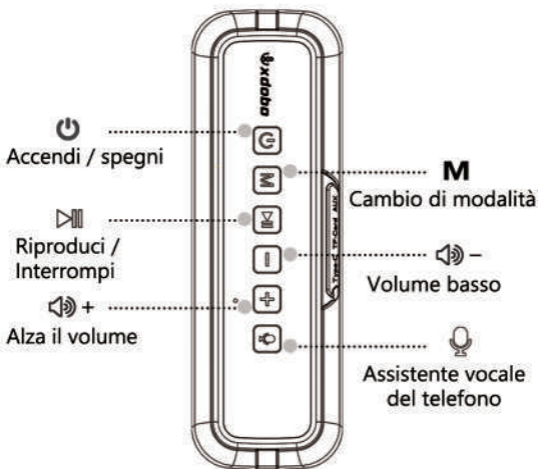

# X8 II

## Quick Start Guide

### 5/Indicazione LED

Stato	Indicazione LED
 Modalità di accoppiamento	 Lampeggiante veloce
 Bluetooth connesso	 On
 Carta TF / gioco Aux	 On
 Ricarica	 OFF
 Super bassi	 On
 Vocale	  On
 Frequenza piena	   On
 Completamente carico	 OFF
 Modalità TWS	 Lampeggiante veloce

### 6/Bluetooth pairing

Quando l'altoparlante è acceso, il LED blu lampeggia.  
Trova "X8" sul tuo dispositivo e seleziona per accoppiare.

## 7 / Specifiche

- Versión de Bluetooth: 5.0
- Power Potenza de salida: 60W RMS
- Respuesta de frecuencia: 80hz-18kHz
- Relación señal / ruido: 80 ± 2dB
- Tipo de batería: 3.7V / 6600mAh
- Tempo di ricarica della batteria: circa 3 ore
- Potenza in ingresso: Type-c 5V / 2A
- Time Tiempo de reproducción de música: hasta 8 horas (varía según el volumen nivel y contenido de audio)
- Dimensiones(H×W×D):220×95×72(mm)/8.7"×3.7"×2.8"
- Peso: 860g / 1.9 lbs

## 8 / Ottimizzazione delle prestazioni

\* Il tempo di utilizzo dell'altoparlante varia a seconda del volume e del brano.

\* Suonare al volume più alto e riprodurre brani con bassi pesanti accelererà il consumo della batteria.

(1) Quando l'X8 è sintonizzato sul massimo suono, proteggerà i componenti dell'altoparlante, inclusa l'ottimizzazione della durata della batteria e del tempo di riproduzione.

(2) Cioè, per suonare più a lungo e ridurre il consumo della batteria, il bilanciamento del tono verrà regolato in modo appropriato, inclusa la regolazione delle parti dei bassi, degli acuti e delle voci.

(3) Pertanto, i livelli dei bassi più alti e di medio volume sono diversi.

\* XDOBO consiglia di regolare l'X8 su un volume medio per l'ascolto, questo manterrà il miglior suono e le migliori prestazioni della batteria.

*xdobo*

Обновлено

# X8 II



— РУКОВОДСТВО —

# X8 II

## Quick Start Guide

### 1 / Предупреждение

\* Не используйте быстрое зарядное устройство, зарядное устройство PD, зарядное устройство GaN или выход быстрой зарядки более 5 В-2 А.

\* XODOBO X8 имеет водонепроницаемость IPX5. Не подвергайте XODOBO X8 воздействию воды во время зарядки.

\* Это может привести к необратимому повреждению динамика или источника питания.

### 2 / Что такое TWS?

TWS означает настоящее беспроводное стерео. Допустим, два динамика Bluetooth могут быть сопряжены и воспроизводить музыку синхронно.

Как подключить ваше устройство?

1: Перед включением убедитесь, что эти два динамика отключены от устройства Bluetooth. Тогда включите, пожалуйста, два динамика.

2: Выберите любой из динамиков. Дважды щелкните кнопку «питание», чтобы войти в статус TWS.

3: После успешного сопряжения светодиодный индикатор на любом динамике будет гореть желтым, а другой динамик будет мигать синим.

4: Найдите X8 на своем устройстве, выберите его и подключитесь.

5: Как только динамики будут правильно сопряжены в первый раз, они будут автоматически сопряжены в следующий раз без указанной выше операции сопряжения.







6: Если раньше динамик был сопряжен, рекомендуется нажать кнопку «голос» в течение 5 секунд, чтобы принудительно отключить питание. Затем перезапустите и повторно подключите тот же динамик к требуемому новому динамику в соответствии с приведенными выше инструкциями, пункт 1 - пункт 4.

7: Когда динамики спарены, только «главный» динамик ответит на звонок.

8. Звуковые эффекты эквалайзера (кнопка M) можно использовать в режиме TWS.



## 3 / Функциональная клавиша

Ключ	Операция	Инструкция
	Короткое нажатие	Включить
	Долгое нажатие	Выключи
	Двойной клик	Дважды щелкните кнопку, чтобы войти в режим TWS.
	Короткое нажатие	Смена режима: BT-TF-AUX
	Долгое нажатие	Изменение звука: Бас-вокал-полная частота
	Короткое нажатие	1: воспроизведение /остановка 2: отвечать на звонки / повесить трубку 3: Быстрый двойной щелчок для набора последнего номера
	Долгое нажатие	Отключено / отклонить ответ
	Короткое нажатие	Уменьшение громкости, всего 16 градусов
	Долгое нажатие	Предыдущий трек
	Короткое нажатие	Увеличение громкости, всего 16 градусов
	Долгое нажатие	Следующий трек
	Короткое нажатие	Включите функцию голосового помощника на телефоне
	Долгое нажатие	Начать сначала

# X8 II

Quick Start Guide

## 4 / Обзор

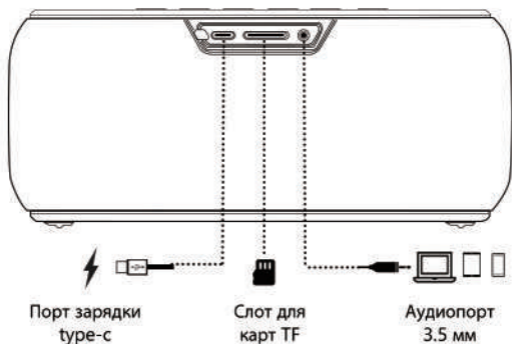
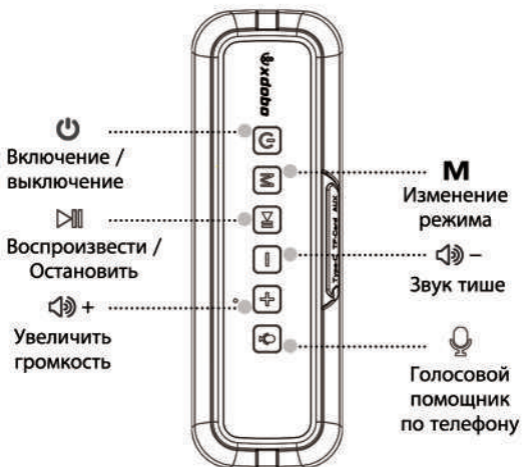

## 5 / Светодиодная индикация

Положение дел	Светодиодная индикация
 Режим сопряжения	 Быстро мигает
 Bluetooth подключен	 На
 TF-карта / Aux play	 На
 Зарядка	 ВЫКЛ.
 Супер бас	 На
 Вокал	  На
 Полная частота	   На
 Полностью заряжена	 ВЫКЛ.
 Режим TWS	 Быстро мигает

## 6 / Bluetooth-соединение

Когда динамик включен, синий светодиод будет мигать. Найдите «X8» на своем устройстве и выберите для сопряжения.

# X8 II

Quick Start Guide

## 7 / Характеристики

- Версия Bluetooth: 5.0
- Выходная мощность: 60 Вт RMS
- Частотный диапазон: 80 Гц-18 кГц
- Соотношение сигнал / шум:  $80 \pm 2$  дБ
- Тип батареи: 3.7 В / 6600 мАч
- Время зарядки аккумулятора: около 3 часов
- Входная мощность: Type-c 5 В / 2 А
- Время воспроизведения музыки: до 8 часов (зависит от уровня громкости и аудиоконтента)
- Размеры (В × Ш × Г): 220 × 95 × 72 (мм) / 8.7 дюйма × 3.7 дюйма × 2.8 дюйма
- Вес: 860 г / 1.9 фунта

## 8 / Оптимизация производительности

\* Время использования динамика зависит от громкости и композиции.

\* Играя на максимальной громкости и играя тяжелые басовые песни, вы ускоряете расход заряда батареи.

(1) Когда X8 настроен на максимальный звук, он защищает компоненты динамика, в том числе оптимизирует срок службы батареи и время воспроизведения.

(2) То есть для того, чтобы играть дольше и снизить расход заряда батареи, баланс тона будет соответствующим образом отрегулирован, включая регулировку низких, высоких и вокальных партий.

(3) Следовательно, уровни самых громких и средних басов различаются.

\* XDOVO рекомендует настроить X8 на средний уровень громкости для прослушивания, это позволит сохранить наилучший звук и производительность аккумулятора.

*xdobo*

アップグレード

# X8 II



— マニュアル —

# X8 II

## Quick Start Guide

### 1 / 警告

- \*急速充電器、PD充電器、GaN充電器、または5V-2A出力を超える急速充電は使用しないでください。
- \* XODOBO X8はIPX5防水です。充電中はXODOBO X8を水にさらさないでください。
- \* そのため、スピーカーまたは電源に恒久的な損傷を与える可能性があります。

### 2 / TWSとは何ですか？

TWSは真のワイヤレスステレオを意味します。2つのBluetoothスピーカーをペアリングして、音楽を同期して再生できるとしましょう。



デバイスをペアリングする方法は？

- 1：ペアリングするこれら2つのスピーカーをオンにする前に、Bluetoothデバイスから切断されていることを確認してください。次に、2つのスピーカーをオンにしてください。
- 2：スピーカーのいずれかを選択します。「電源」ボタンをダブルクリックして、TWSステータスを入力します。
- 3：ペアリングに成功すると、一方のスピーカーのLED表示ライトが黄色のままになり、もう一方のスピーカーが青色に点滅します。
- 4：デバイスでX8を見つけ、選択して接続します。
- 5：スピーカーが最初に適切にペアリングされると、上記のペアリング操作なしで、次回自動的にペアリングされます。
- 6：スピーカーをペアリングしていた場合は、「音声」ボタンを5秒間押し、強制的に電源を切ることをお勧めします。次に、再起動し、上記の指示項目1-項目4に従って、同じスピーカーが必要な新しいスピーカーと再ペアリングします。
- 7：スピーカーがペアリングされている場合、「マスター」スピーカーのみが電話に応答します。
- 8：TWSモードでEQ（Mボタン）効果音を使用できます。

# X8 II

## Quick Start Guide

### 3 / ファンクションキー

キー	操作	命令
	短押し	オンにする
	長押し	消す
	ダブルクリック	ボタンをダブルクリックしてTWSモードに入ります。
M	短押し	モード変更：BT-TF-AUX
	長押し	音の変化： バス-ボーカル-フル周波数
	短押し	1: 再生/停止 2: 電話に出る/電話を切る 3: クイックダブルクリックして最後の番号をダイヤルします
	長押し	切断/応答を拒否
-	短押し	音量を下げ、合計16度
	長押し	前のトラック
+	短押し	ボリュームアップ、合計16度
	長押し	次のトラック
	短押し	電話の音声アシスタント機能をオンにする
	長押し	再起動

# X8 II

## Quick Start Guide

### 4 / 概要概要

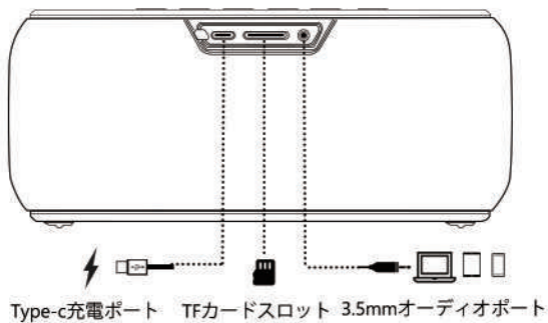
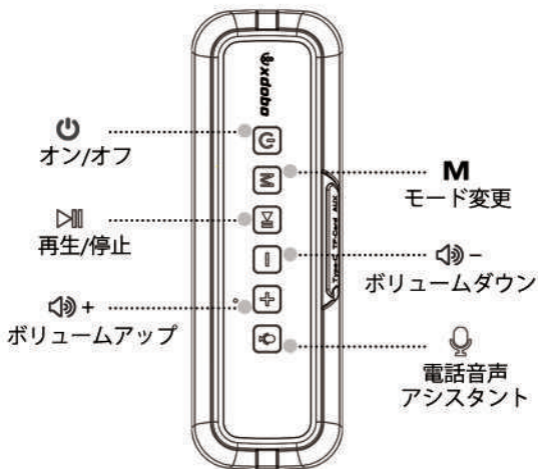



# X8 II

## Quick Start Guide

### 5 / LED表示

状態	LED表示
 ペアリングモード	 速い点滅
 Bluetooth接続	 オン
 TFカード/補助プレイ	 オン
 充電	 オフ
 スーパーベース	 オン
 ボーカル	  オン
 フル周波数	   オン
 フル充電済み	 オフ
 TWSモード	 速い点滅

### 6 / Bluetoothペアリング

スピーカーの電源がオンになると、青いLEDが点滅します。

デバイスで「X8」を見つけて、ペアリングすることを選択します。

# X8 II

## Quick Start Guide

### 7 / 仕様

- Bluetoothバージョン：5.0
- 出力電力：60W RMS
- 周波数応答：80hz-18kHz
- 信号対雑音比：80±2dB
- バッテリータイプ：3.7V / 6600mAh
- バッテリー充電時間：約3時間
- 入力電力：Type-c 5V / 2A
- 音楽の再生時間：最大8時間（音量レベルとオーディオコンテンツによって異なります）
- 寸法(高さ×幅×奥行):220×95×72(mm)/8.7"×3.7"×2.8"
- 重量：860g / 1.9 lbs

### 8 / パフォーマンスの最適化

※スピーカーの使用時間は、音量や曲によって異なります。

\*最も大きな音で再生し、重低音の曲を再生すると、バッテリーの消費が速くなります。

(1) X8を最大音にチューニングすると、バッテリーの耐久性や再生時間の最適化など、スピーカーのコンポーネントを保護します。

(2) つまり、より長く演奏し、バッテリー消費を減らすために、低音、高音、ボーカルのパートの調整を含め、トーンのバランスが適切に調整されます。

(3) したがって、大音量と中音量の重低音のレベルが異なります。

\* XDOBOは、X8を中程度の音量に調整して聞くことをお勧めします。これにより、最高のサウンドとバッテリー性能が維持されます。