

ARZOPA

P101W

10.1 inch WiFi Digital Picture Frame



User Manual

TABLE OF CONTENTS

English -----	(1~7)
Video Tutorial -----	1
Frame Introduction -----	2
Start Setup -----	3
Invite Friends and Start Sharing -----	5
Package Contents -----	7
Deutsch -----	(8~14)
Videoanleitung -----	8
Einführung von Frame -----	9
Starten Sie die Einrichtung -----	10
Laden Sie Freunde ein und beginnen Sie mit dem Teilen -----	12
Packungsinhalt -----	14
Français -----	(15~21)
Didacticiel Vidéo -----	15
Présentation du Cadre -----	16
Démarrer la Configuration -----	17
Invitez des Amis et Commencez à Partager -----	19
Contenu du Colis -----	21
Italiano -----	(22~28)
Esercitazione Video -----	22
Introduzione al Telaio -----	23
Avvia la Configurazione -----	24
Invita Amici e Inizia a Condividere -----	26
Contenuto del Pacco -----	28
Español -----	(29~35)
Video Tutorial -----	29
Introducción al Marco -----	30
Iniciar Configuración -----	31
Invita amigos y Comienza a Compartir -----	33
Contenidos del Paquete -----	35

Thank you for choosing ARZOPA digital photo frame!

After setting up the frame, you can invite your family or friends to connect to it and share to the frame.

Please check out our "Frameo Tutorials" on Youtube where you can learn how to get started with Frameo.

Please scan the QR code below to find the playlist



Frame Introduction

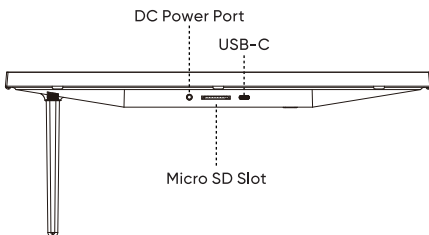
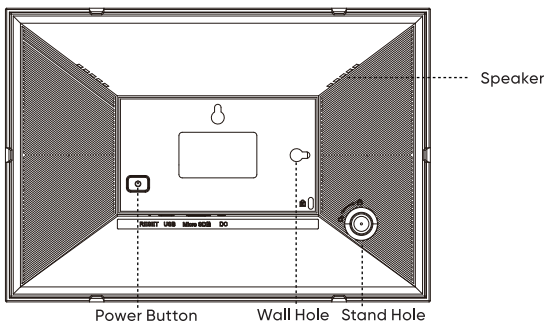
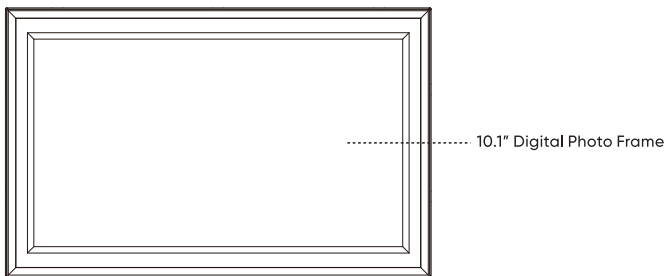

Start Setup

Step 1

Insert the stand into the hole on the frame

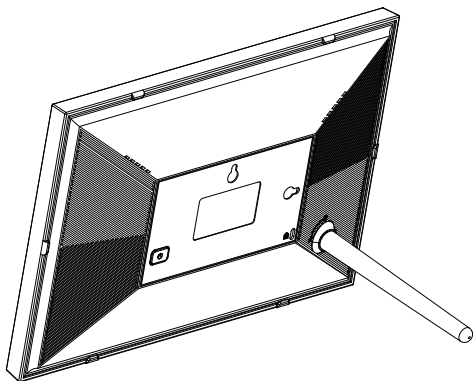

Step 2

Insert power cord firmly

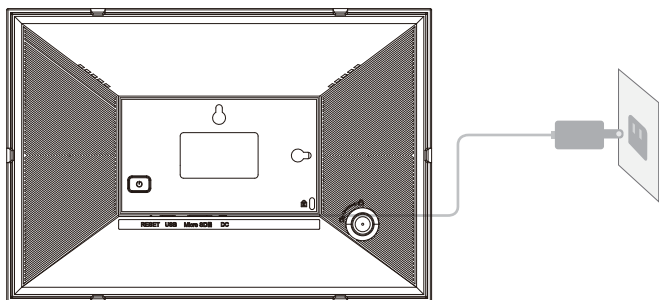

Step 3

Set your frame, language, Wi-Fi, frame naming, time zone, etc.

Step 4

Download and install FRAMEO APP in App Store(IOS) or Google Play(Android)

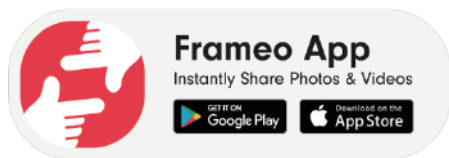

Scan code to find the app

Now you can invite your family and friends to share photos to your frame!

Step 1 Connecting a new friend

- 1.Download and install Frameo APP
- 2.Click the add friend icon to show a sharing code(valid for 12 hours)
- 3.Share the code to your friend
- 4.Enter the code via Frameo APP



Step 2 Send Photos/Videos to The Frame

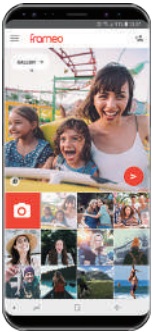

1

Take a picture or
choose from your
gallery



2

Choose one or
more recipients



3

Set the scene with a
caption



4

Choose the right
part and send it

Package Contents



Digital Photo Frame



Stand

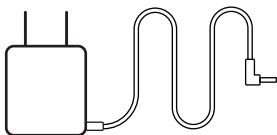

Power Adapter with
Power Cable

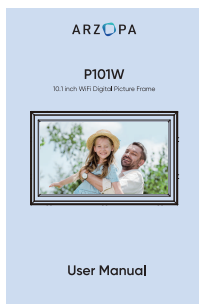

User Manual

Vielen Dank, dass Sie sich für den digitalen Bilderrahmen von ARZOPA entschieden haben!

Nachdem Sie den Rahmen eingerichtet haben, können Sie Ihre Familie oder Freunde einladen, sich mit ihm zu verbinden und Inhalte auf dem Rahmen zu teilen.

Bitte schauen Sie sich unsere „Frameo-Tutorials “ auf Youtube an, in denen Sie lernen können, wie Sie mit Frameo beginnen.
Bitte scannen Sie den QR-Code unten, um die Playlist zu finden



Einführung von Frame

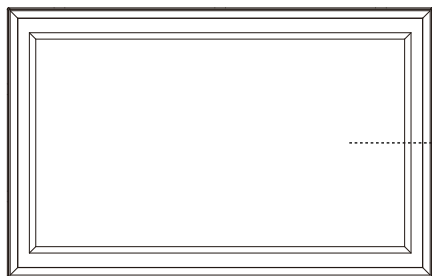

10,1" Digitaler Fotorahmen

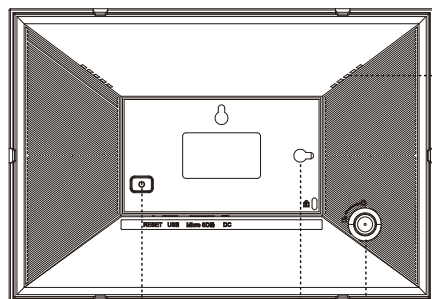

Lautsprecher

Power-Taste

Wandloch

Halterungsloch

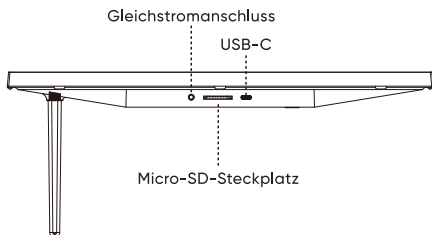

Gleichstromanschluss

USB-C

Micro-SD-Steckplatz

Starten Sie die Einrichtung

Schritt 1

Setzen Sie den Ständer in das Loch am Rahmen ein

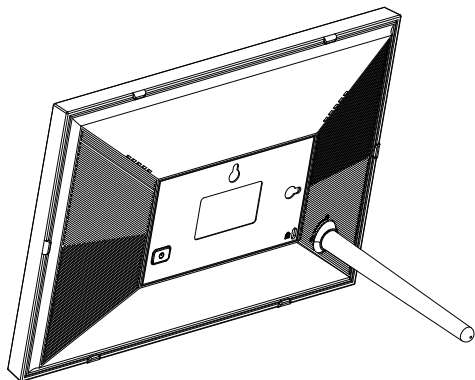

Schritt 2

Netzkabel einstecken

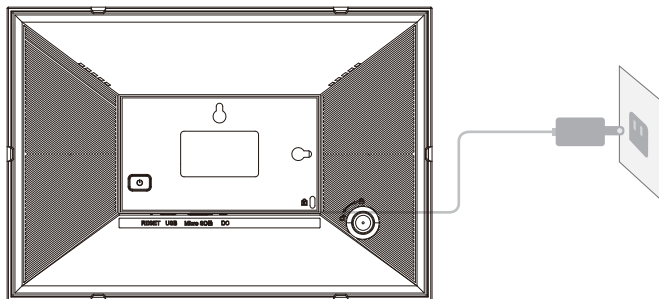

Schritt 3

Stellen Sie Ihren Rahmen mit Sprache, WLAN, Rahmenbenennung, Zeitzone usw. ein.

Schritt 4

Laden Sie die FRAMEO APP im App Store (IOS) oder Google Play (Android) herunter und installieren Sie sie.

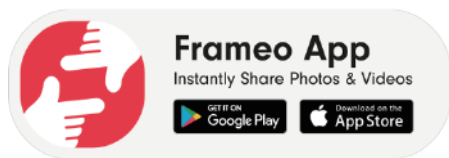

Scan code to find the app

Jetzt können Sie Ihre Familie und Freunde einladen, Fotos auf Ihrem Rahmen zu teilen!

Schritt 1 Einen neuen Freund verbinden

1. Laden Sie die Frameo-App herunter

und installieren Sie sie

2. Klicken Sie auf das Symbol „Freund hinzufügen“,

um einen Freigabecode anzuzeigen

(gültig für 12 Stunden).

3. Teilen Sie den Code Ihrem Freund mit

4. Geben Sie den Code über die Frameo-App ein



Schritt 2: Senden Sie Fotos/Videos an den Rahmen

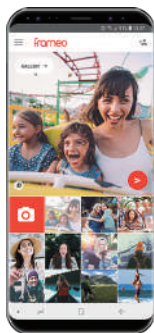

1

Machen Sie ein Foto oder wählen Sie aus Ihrer Galerie



2

Wählen Sie einen oder mehrere Empfänger aus



3

Gestalten Sie die Szene mit einer Bildunterschrift



4

Wählen Sie das richtige Teil aus und senden Sie es

Packungsinhalt

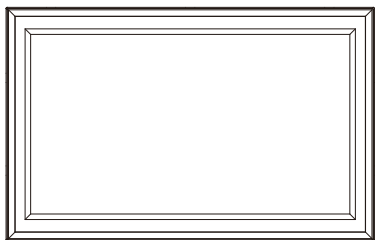

Digitaler Fotorahmen



Halterung

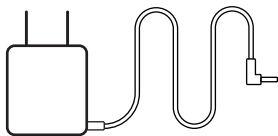

Netzteil mit Netzkabel

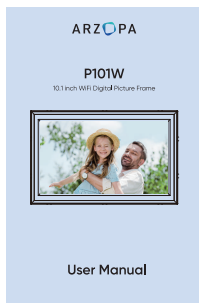

Benutzerhandbuch

Merci d'avoir choisi ARZOPA cadre photo numérique!

Après avoir configuré le cadre, vous pouvez inviter votre famille ou vos amis à s'y connecter et à partager sur le cadre.

Veillez consulter nos « Tutoriels Frameo » sur Youtube où vous pourrez apprendre comment démarrer avec Frameo.
Veillez scanner le code QR ci-dessous pour trouver la playlist



Présentation du cadre

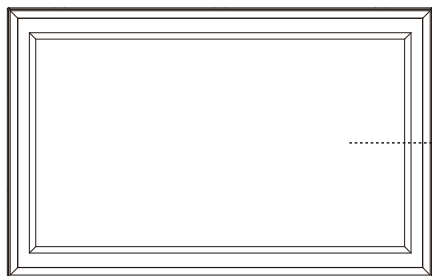

10,1" Cadre photo numérique

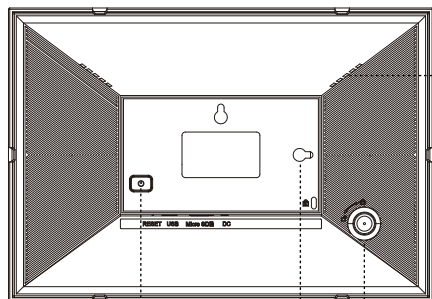

Conférencier

Bouton d'alimentation

Trou de support

Trou de suspension murale

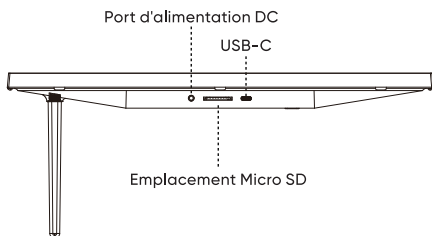

Port d'alimentation DC

USB-C

Emplacement Micro SD

Démarrer La Configuration

Étape 1

Insérez le support dans le trou du cadre

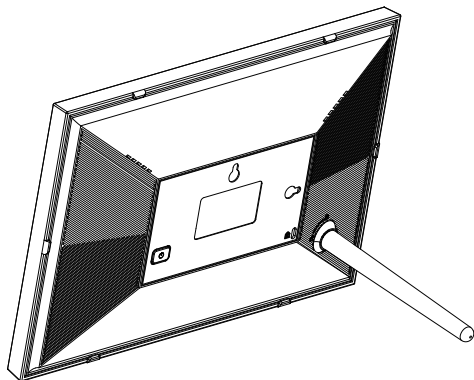

Étape 2

Insérer le cordon d'alimentation

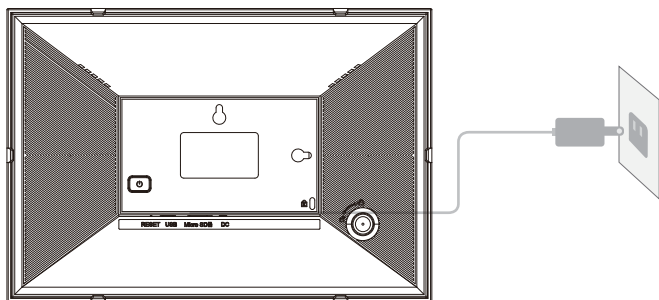

Étape 3

Définissez votre cadre avec la langue, le WiFi, le nom du cadre, le fuseau horaire, etc.

Étape 4

Téléchargez et installez l'application FRAMEO dans l'App Store (IOS) ou Google Play (Android)

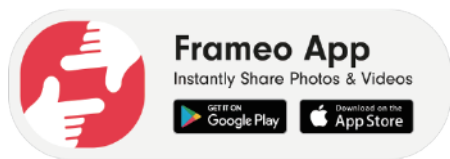

Scan code to find the app

Vous pouvez désormais inviter votre famille et vos amis à partager des photos sur votre cadre!

Étape 1 Connecter un nouvel ami

1. Téléchargez et installez l'application Frameo
2. Cliquez sur l'icône Ajouter un ami pour afficher un code de partage (valable 12 heures)
3. Partagez le code avec votre ami
4. Entrez le code via l'application Frameo



Étape 2 : Envoyez des photos/vidéos au cadre

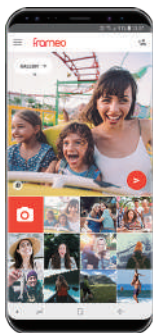

1

Prenez une photo
ou choisissez dans
votre galerie



2

Choisissez un ou
plusieurs
destinataires



3

Plantez le décor
avec une légende



4

Choisissez la bonne
pièce et envoyez-la

Contenu du Colis

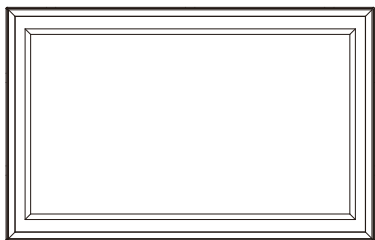

Cadre photo numérique



Support

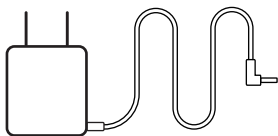

Adaptateur secteur avec
câble d'alimentation

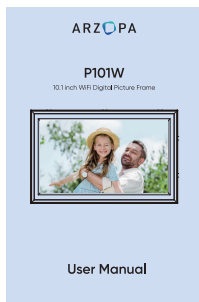

Manuel de l'Utilisateur

Grazie per aver scelto ARZOPA cornice digitale!

Dopo aver configurato la cornice, puoi invitare la tua famiglia o i tuoi amici a connettersi ad essa e condividere sulla cornice.

Consulta i nostri "Tutorial Frameo" su Youtube dove potrai imparare come iniziare con Frameo.

Scansiona il codice QR qui sotto per trovare la playlist



Introduzione al telaio

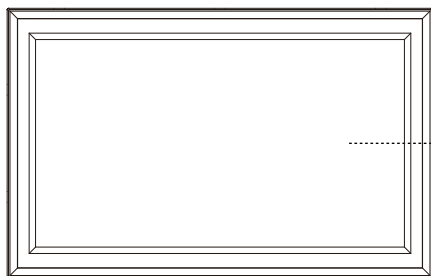

10,1" Cornice digitale

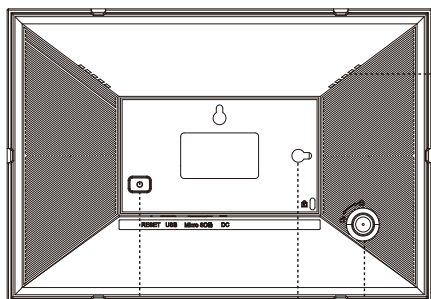

Altoparlante

pulsante di accensione

foro della staffa

Foro per appendere al muro

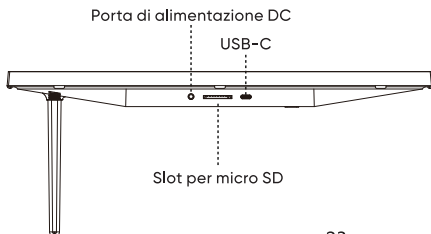

Porta di alimentazione DC

USB-C

Slot per micro SD

Avvia La Configurazione

Passo 1

Inserire il supporto nel foro sul telaio

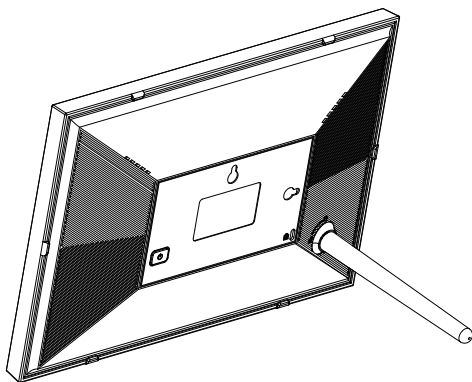

Passo 2

Inserire il cavo di alimentazione

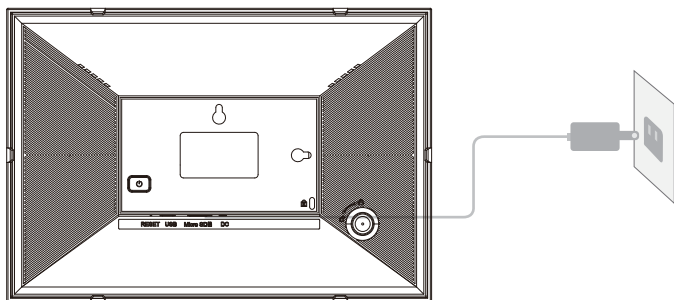

Passo 3

Imposta la cornice con lingua, WiFi, denominazione della cornice, fuso orario, ecc.

Passo 4

Scarica e installa l'APP FRAMEO nell'App Store (IOS) o Google Play (Android)

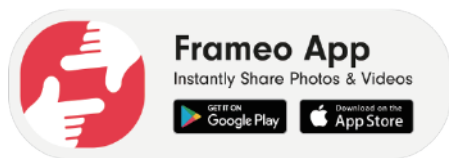

Scan code to find the app

Ora puoi invitare la tua famiglia e i tuoi amici a condividere le foto sulla tua cornice!

Passo 1 Connettersi a un nuovo amico

1. Scarica e installa l'APP Frameo
2. Fare clic sull'icona Aggiungi amico per mostrare un codice di condivisione (valido per 12 ore)
3. Condividi il codice con il tuo amico
4. Inserisci il codice tramite l'APP Frameo



Passaggio 2 Invia foto/video alla cornice

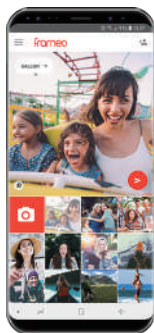

1

Scatta una foto o scegli dalla tua galleria



2

Scegli uno o più destinatari



3

Imposta la scena con una didascalia



4

Scegli la parte giusta e inviala

Contenuto del Pacco

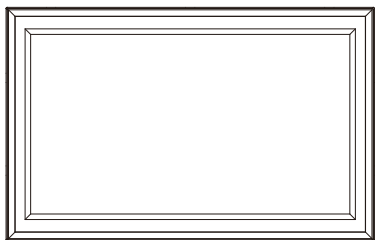

Cornice per foto digitali



Supporto

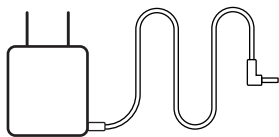

Adattatore di alimentazione con cavo di alimentazione

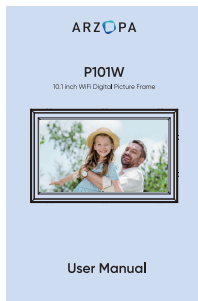

Manuale d'uso

¡Gracias por elegir ARZOPA marco de fotos digital!

Después de configurar el marco, puede invitar a su familia o amigos a conectarse y compartir en el marco.

Consulte nuestros "Tutoriales de Frameo" en Youtube, donde podrá aprender cómo empezar a utilizar Frameo. Escanee el código QR a continuación para encontrar la lista de reproducción.



Introducción al marco

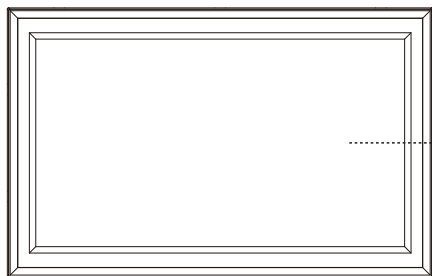

10,1" Marco de fotos digitales

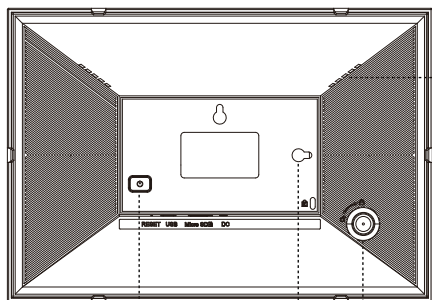

Vocero

botón de encendido

agujero del soporte

Agujero para colgar en la pared

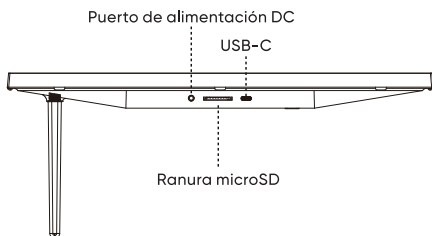

Puerto de alimentación DC

USB-C

Ranura microSD

Iniciar Configuración

Paso 1

Inserte el soporte en el orificio del marco.

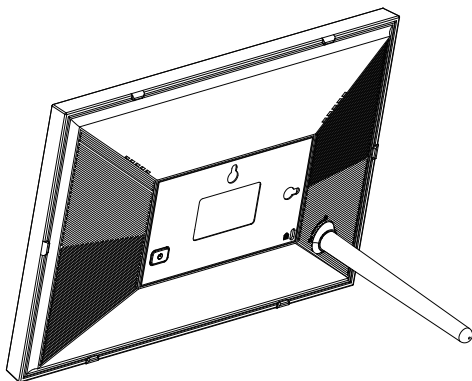

Paso 2

Insertar cable de alimentación

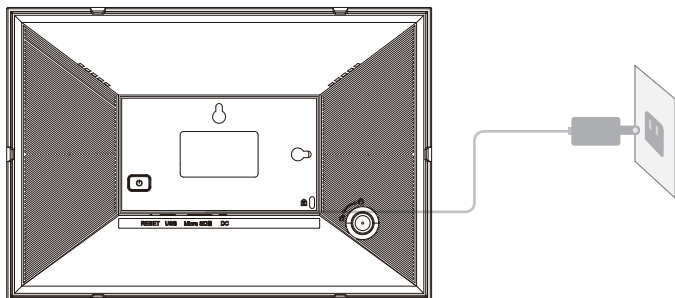

Paso 3

Configure su marco con idioma, WiFi, nombre de marco, zona horaria, etc.

Paso 4

Descargue e instale la APLICACIÓN FRAMEO en App Store (IOS) o Google Play (Android)

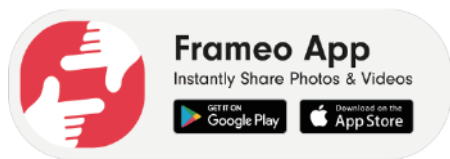

Scan code to find the app

¡Ahora puedes invitar a tus familiares y amigos a compartir fotos en tu marco!

Paso 1 Conéctate con un nuevo amigo

- 1.Descargue e instale la aplicación Frameo
- 2.Haga clic en el icono de agregar amigo para mostrar un código para compartir (válido por 12 horas)
- 3.Comparte el código con tu amigo.
- 4.Ingrese el código a través de la aplicación Frameo



Paso 2 Enviar fotos/vídeos al marco

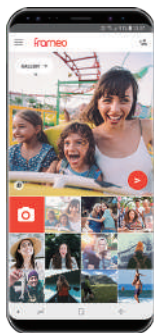

1

Toma una foto o elige de tu galería



2

Elija uno o más destinatarios



3

Prepara la escena con un título



4

Elige la pieza correcta y envíala

Contenidos del Paquete

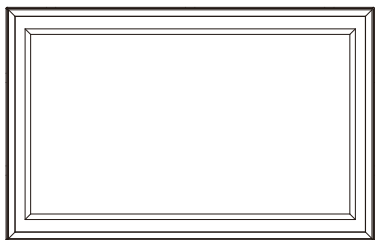

Marco de foto digital



Soporte

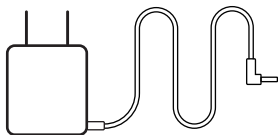

Adaptador de corriente con cable de alimentación

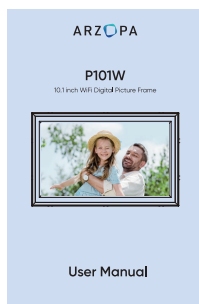

Manual de usuario

We're here to help

ARZOPA is always striving to achieve your total satisfaction! Should you ever have any questions about your item, please feel free to email our Lifetime Service Center.



Recycling & Environmentally Friendly Disposal



In order to protect the environment, after the expiration of the products service life, it should not be discarded in the same way as domestic garbage; Please recycle at a professional recycling center. For further information on the recycling of this product, please consult your local municipality, processing service center, or the store where you purchased the product. You can help protect the environment! Please remember to respect the local regulations, and hand in the non-working electrical equipment to an appropriate waste disposal center.

WEEE-Reg.-Nr. DE 81513723

Email: support@arzopa.com

Website: www.arzopa.com