

Item type

Wall Lamp

Item name

Nuvola S

Item number(s)

116391

Attention!

Turn off the electricity supply at the main circuit panel before installing. Do not connect the electricity supply until your luminaire is fully assembled and installed.

Care instructions:

Wipe with a soft dry cloth, do not use chemicals or abrasive cleaning materials.

Eichholtz B.V.

Delfweg 52
2211 VN Noordwijkerhout
The Netherlands

🏠 www.eichholtz.com
✉ service@eichholtz.com
☎ +31 (0)252 515 850

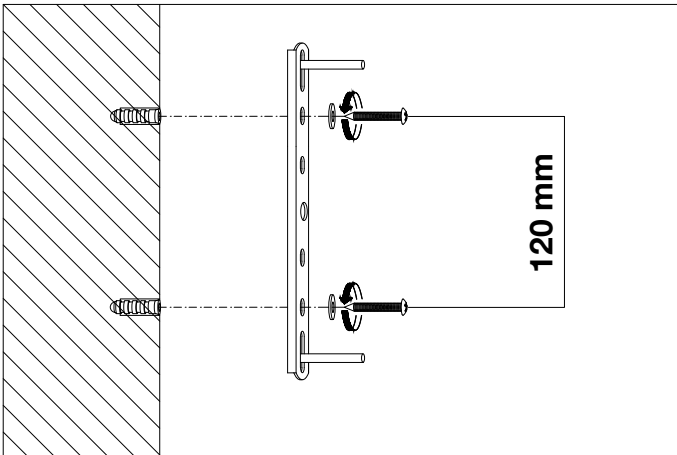

1. Fix the crossbar to the wall by using wall mounting plugs and screws suitable to your wall type.

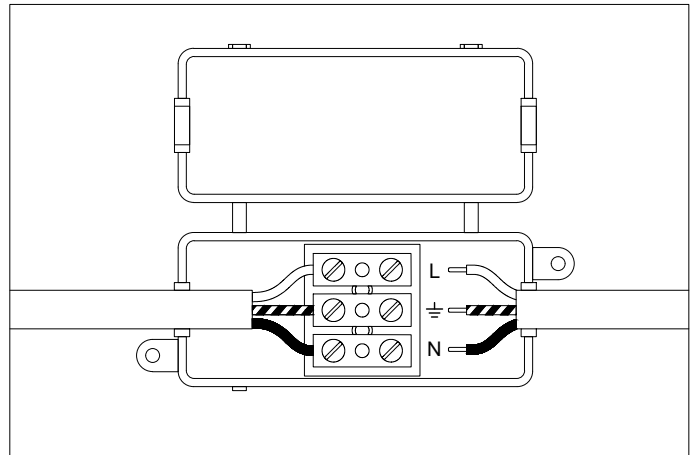

2. Connect the 3 wires according to their colours. Brown is the live wire (L), blue is the neutral wire (N), green/yellow is the earth wire (⊕).

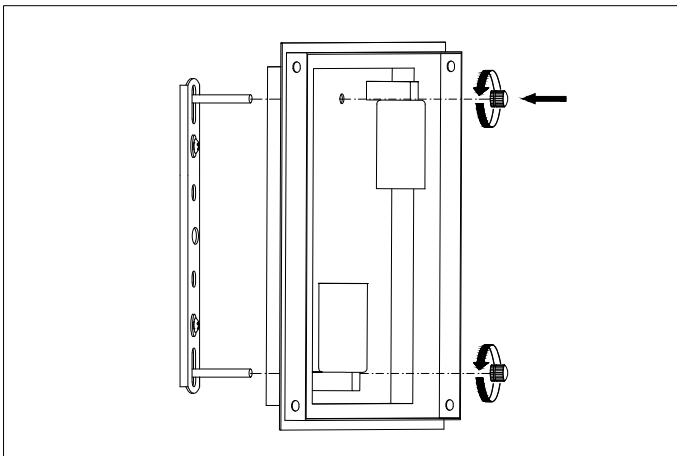

3. Place the lamp over the crossbar and fix it securely with the nuts.

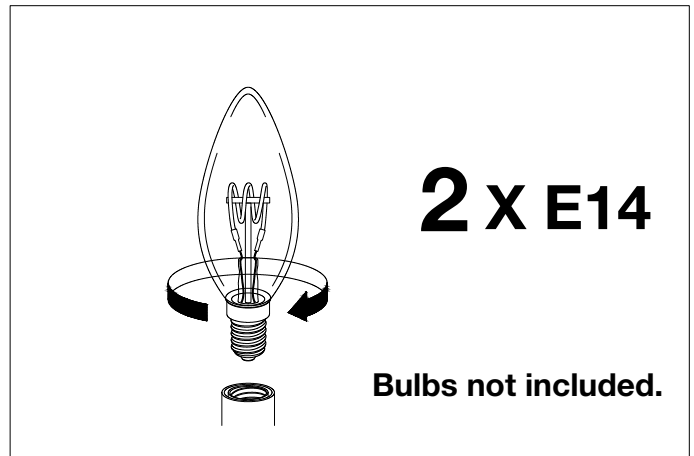

4. Place the bulbs.

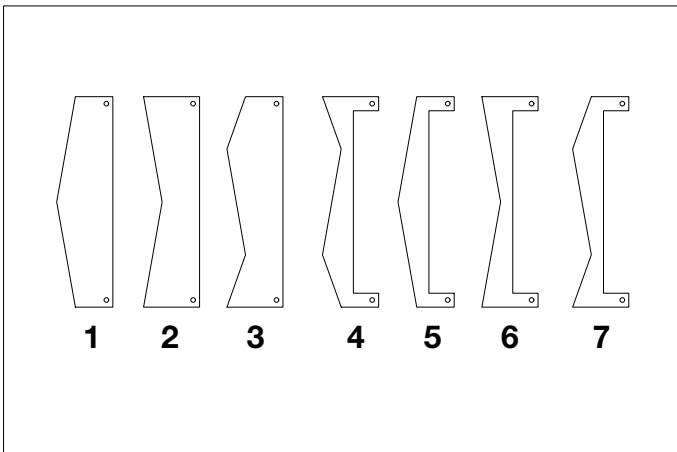

5. Sort the glass.

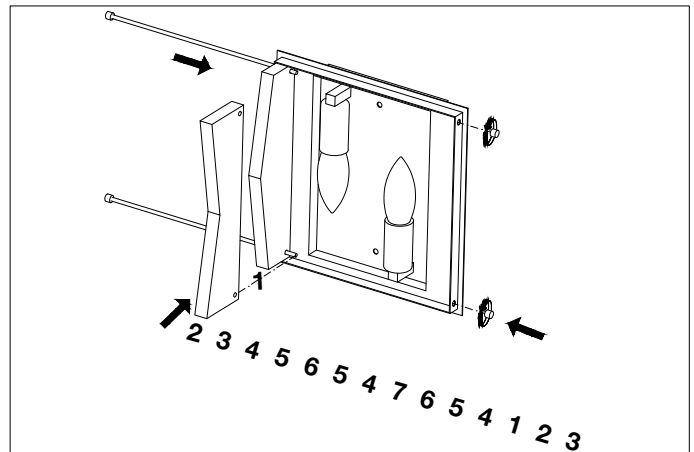

6. Place the glass according to the schedule and fix it with the nuts.