



E I C H H O L T Z

111508 WALL LAMP WESTBROOK

ASSEMBLY INSTRUCTION

PARTS

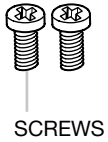

SCREWS

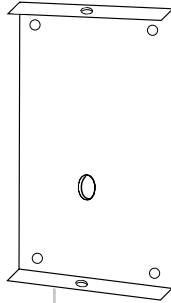

WALL PLATE (A)

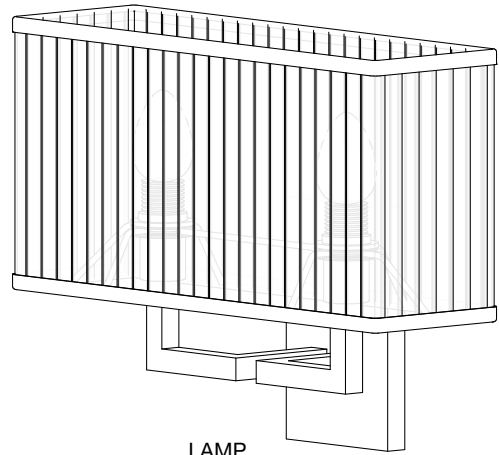

LAMP

1

WALL PLATE (A)

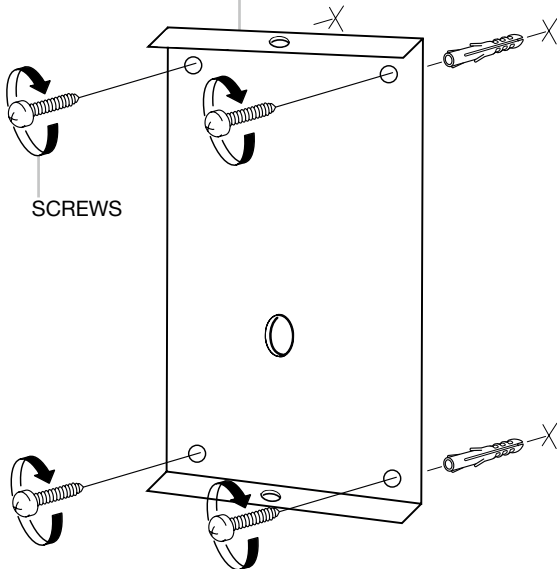

SCREWS

2

SCREWS

CROSSBAR (A)

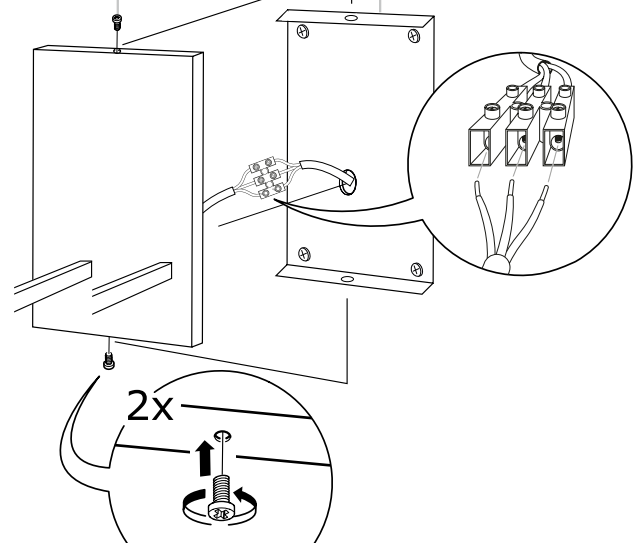

2x

Turn-off the electricity supply at the main circuit panel before installing. Do not connect electricity supply until your wall lamp is fully assembled and installed.

Fix the wall plate (A) to the wall by using wall mounting plugs and screws suitable to your wall type.

Connect the 3 power wires according to their colours. Brown is the live wire, blue is the neutral wire, the green yellow wire is the earthwire.

Place the lamp over the wall plate and fix it securely with the screws supplied.

CARE INSTRUCTION

Wipe clean with soft, dry cloth.
Always avoid the use of harsh chemicals or abrasive cleaners as they may cause damage to the fixture's finish.