



MEDICAL-GRADE
RED LIGHT
THERAPY

300W. 900W. 1800W.





TABLE OF CONTENTS

- 1 – PRODUCT OVERVIEW**
- 2 – UNDERSTANDING RED LIGHT THERAPY**
- 3 – PRODUCT SPECS AND COVERAGE**
- 4 – HOW TO SETUP YOUR DEVICE**
- 5 – FREQUENTLY ASKED QUESTIONS**
- 6 – SAFETY INSTRUCTIONS**
- 7 – MAINTINENCE AND WARRANTY**



SUN HOME SAUNAS RLT SERIES

Congrats on your brand-new Sun Home Saunas series, a high-powered device delivering over 140mw/cm² of light to your body in two different wavelengths: 660 nanometer as well as 850 nanometer. As you may have already learned, these are clinically proven wavelengths of natural light that have been extensively studied and have shown to have the greatest effect on human biology.

Sun Home Saunas RLT series is the most advanced LED therapy system, equipped with a 5W dual-chip light source. The models have smart controls, timer controls, and multiple connections. Please take your time to read this manual to learn everything you need to know to safely and effectively enjoy the benefits that can be derived from the use of daily red and near infrared light therapy. Sun Home Saunas series LED Therapy Light uses 660nm and 850nm light wavelengths. 850nm is infrared which can't be seen by the naked eye, due to the wavelength being outside of the visual spectrum. So please don't worry, they are indeed working!

What's Included:

What's Included

- 1 x LED Therapy Device
- 1x User Manual
- 1 x Power Cord
- 1 x Door Mount
- 1 x Adjustable Rope Clip Hanger
- 1 x Eye Comfortability Glasses
- 1 x Daisy Chain Cable
- 1 x Hanger kit

Understanding RLT

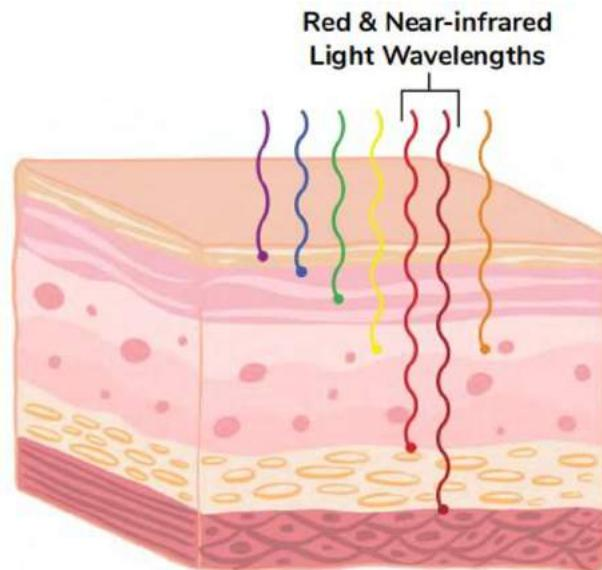

What is LED Light Therapy?

Red and near infrared light therapy is also known as PBM (photobiomodulation). PBM involves the use of specific wavelengths of natural light in the mid 600 and mid 800 nanometer to enhance the health and function of our cells without any harmful UV rays, excess heat, or negative effects. Light therapy is among the earliest recorded healing modalities. Solar therapy was first used by the Egyptians, and forms of light therapy were also practiced by the ancient Greeks, Chinese and Indians. There's no question that light exerts biological effects. In fact, your body needs light to be healthier.

Understanding RLT [Con't]

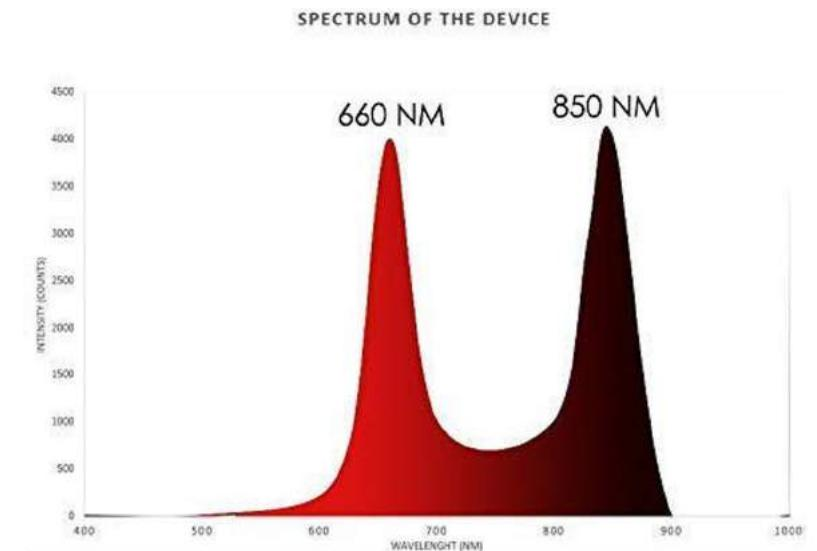

What's the wavelength of RLT?

The new Sun Home Saunas RLT is a combo of red light 660nm and Near Infrared 850nm light. Red light at 660nm is absorbed at higher proportion by skin tissue, making it especially effective for boosting skin health and increasing collagen production. Near Infrared light is at 850nm, and this wavelength is actually outside of the visual spectrum. It appears as if the NIR light is not working, but they just can't be seen by the naked eye. Near infrared light has a particularly strong ability to penetrate deeper into the tissue, organs and joints, making it ideal for enhancing muscle recovery and reducing joint pain.

WHAT ARE THE BENEFITS?

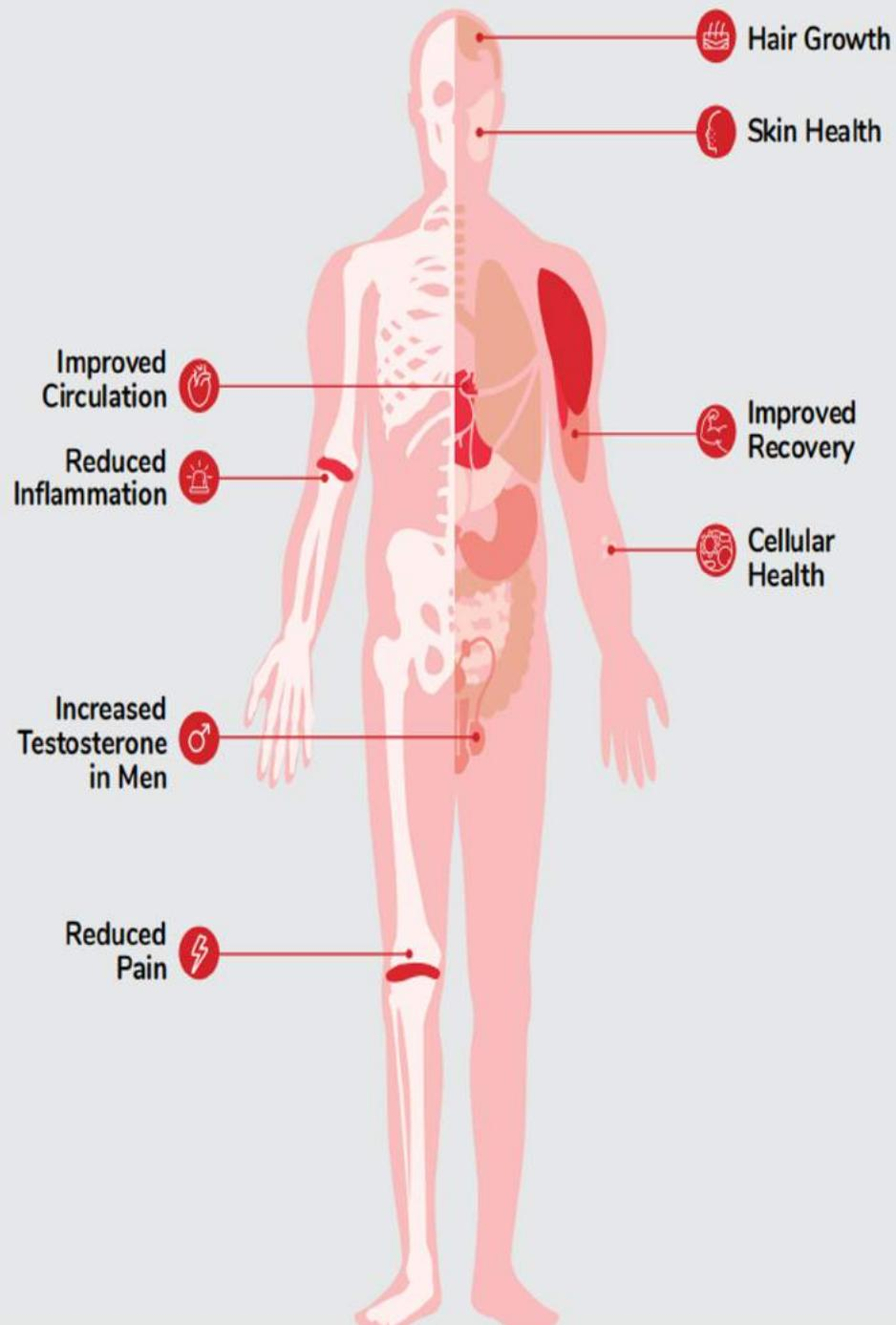

WHAT ARE THE BENEFITS? [CON'T]

| | |
|---|---|
| <p>Reduces Inflammation</p> <p>Near-infrared (NIR) light reduces overall inflammation in the body by decreasing the presence of inflammatory markers. This reduction can help ease the symptoms associated with joint pain, sore muscles, autoimmune diseases, arthritis, traumatic brain injuries, and spinal cord injuries.</p> | <p>Improves Circulation</p> <p>In many studies, LED light therapy has been clinically proven to increase the diameter of blood vessels and to improve circulation. Additionally, LED light therapy protects red blood cells against oxidative stress and limits platelet loss during surgical procedures.</p> |
| <p>Reduces Recovery Time</p> <p>For high-performance athletes (and those who train like them) LED light therapy can help accelerate muscle repair following fatigue and injury. Mitochondria within cells are particularly responsive to LED light therapy, and muscle cells are exceptionally rich in mitochondria. LED light therapy may also stimulate stem cells, further assisting in muscle recovery.</p> | <p>Promotes Healthy Cellular Function</p> <p>The most significant benefit of LED light therapy is the effect it has on the body's cells. One of the most critical outcomes of LED light therapy on cellular function is the stimulation of collagen production. Collagen strengthens hair, is responsible for the health of connective tissue, and provides our skin with firmness and elasticity.</p> |
| <p>Stimulates Hair Growth</p> <p>Alopecia, or hair loss, is a common disorder affecting 50% of males over the age of 40 and 75% of females over 65. Studies have shown that LED light therapy can stimulate hair growth. Red light wavelengths are believed to stimulate epidermal stem cells in the hair follicle, shifting the follicle into the anagen (active growth) stage.</p> | <p>Improves Skin Health</p> <p>LED light therapy can dramatically transform the skin. Red light wavelengths in particular target the mitochondrial chromophores within skin cells, generating production of collagen proteins. Collagen stimulation yields more holistic and enduring benefits than simply resurfacing the outer layers of the skin. Stem cells may also be activated, increasing tissue repair. The result is accelerated healing and wound repair, improved appearance in hypertrophic scars, a reduction in fine lines and wrinkles, and improved skin texture.</p> |
| <p>Increases Fertility</p> <p>Around the age of 30, male testosterone levels naturally start to decrease. Men hope to achieve a natural boost to their sex drives, sexual satisfaction, fertility, and physical performance can reap benefits from LED light therapy. Red and near-infrared wavelengths can stimulate photoreceptor proteins in the testes causing higher testosterone production. Other studies have theorized that low-level light therapy may affect the pineal gland in the brain, which bears a significant impact on reproduction.</p> | <p>Reduces Pain</p> <p>In a clinical study, neuropathic pain caused by a spinal cord injury was dramatically reduced by the application of red light treatment. Near-infrared light wavelengths reduce overall pain by easing joint stiffness and soreness, diminishing inflammation, easing muscle spasms and enhancing blood flow.</p> |

SUN HOME SAUNAS' RED LIGHT THERAPY SERIES



NEXT-LEVEL SELF CARE

Combining powerful wavelengths of light, the Sun Home series features our best spectrum IR+ & NIR+ spectral output, utilizing a perfected blend of deep red light consisting of both 660nm wavelengths and 850nm. Additionally, the Sun Home series includes fully digital controls with a built-in timer. They have also multiple connectors which allowing the ability to connect multiple panels together to create custom sizes, targeted treatment and full body treatment suit your wellness needs.

MODEL SPECIFICATIONS

| Model | 300 Watt | 900 Watt | 1800 Watt |
|---------------|---|--------------------------------|----------------------------------|
| Power | 300W | 900W | 1800W |
| LED | LED 60pcs (30pcs Red / 30pcs NIR) | 180pcs (90pcs Red / 90pcs NIR) | 360pcs (180pcs Red / 180pcs NIR) |
| Wavelength | 660nm:850nm=1:1 | 660nm:850nm=1:1 | 660nm:850nm=1:1 |
| Light Angle | 60 degrees | 60 degrees | 60 degrees |
| Dimensions | 380X235X65mm | 910x235x65mm | 910x412x65mm |
| Irradiance | >140wm/cm2 | >140wm/cm2 | >160wm/cm2 |
| Lifespan | 10,0000 hours | 10,0000 hours | 10,0000 hours |
| Cooling Fans | 1 fans | 5 fans | 8 fans |
| EMF Emission | 0.0μT @10cm | 0.0μT @ 10cm | 0.0μT @ 10cm |
| Device weight | 5KG (with table stand) | 9KG | 15KG |
| Warranty | 5 Years | 5 Years | 5 Years |
| Best For | Target Treatment | Full Body Treatment | Full Body Treatment |
| Max Area | 80cm x 72cm | 140cm x 82cm | 140cm x 127cm |
| Function | Intelligent Timing Control Daisy chain LCD Display MeanWell power driver Flicker free | | |

How To Setup Your Device

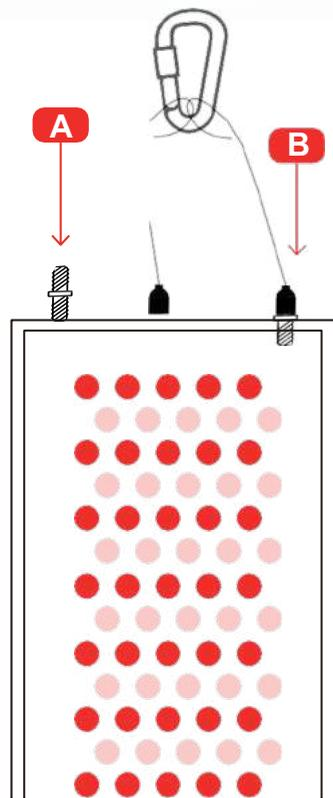

Step 1:

Attach Hanging Hardware. Screw the threaded posts into the top of your light, then screw the cable supports to the top of the threaded posts. If you need to connect multiple light units, please see the following instructions.

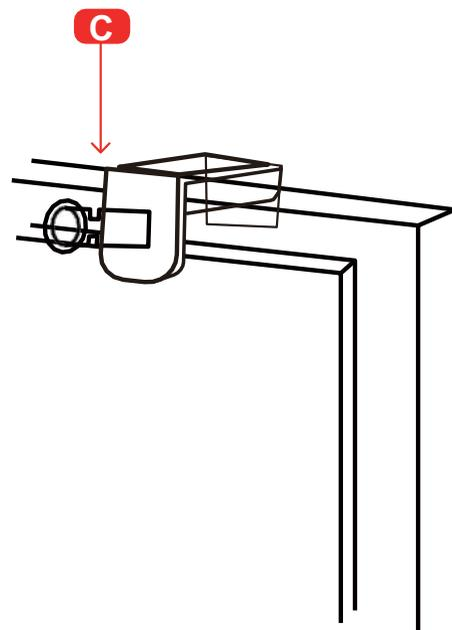

Step 2:

Attach Door Hook(s): Hang the door hook on any standard-size door.

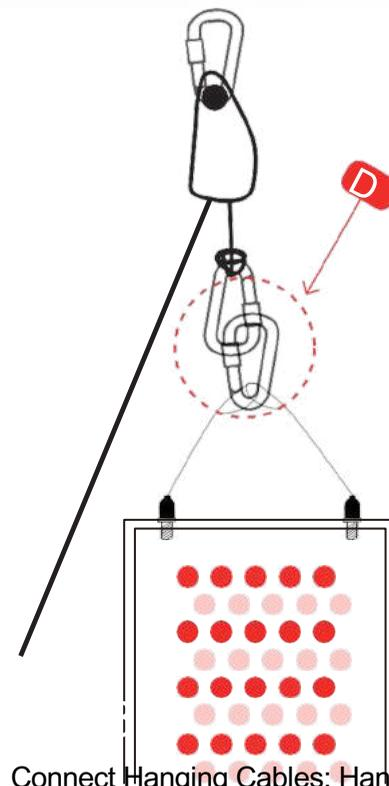

Connect Hanging Cables: Hang the door hook on the top of any standard-sized door. Connect cable supports to the snap link. Then, hang the other end of the cable assembly directly on the door hook. The snap link and attached cable gripper allows you to adjust the height of your therapy light.

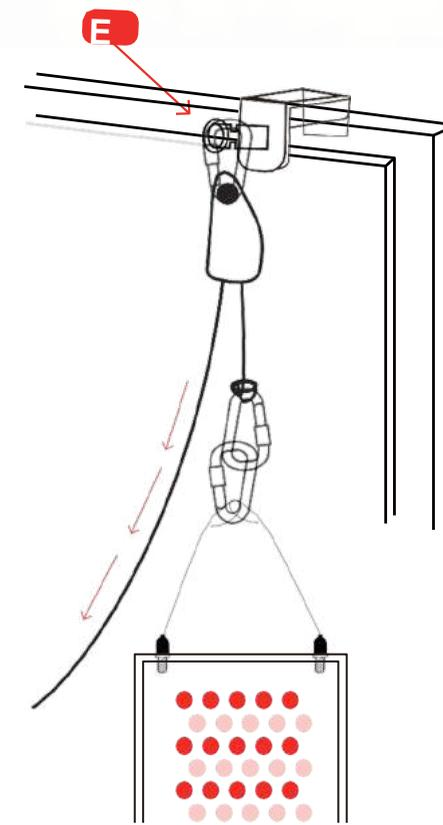

Step 4:

To increase the height of your therapy light, pull down on the height adjustment cable while supporting the bottom of your light with your other hand. To lower your light, press the lever on the cable box. Please adjust it to a height that suits you for better results.

Power Up Your Light:

Step 1: Connect Power Cables

Plug the power cord into the female socket of your therapy light. Next, plug the other end of the power cord into a wall socket. If Connecting Multiple Light Units, Then, connect your Lead unit to your Follow unit using the patch cable. This allows power to flow through both units.

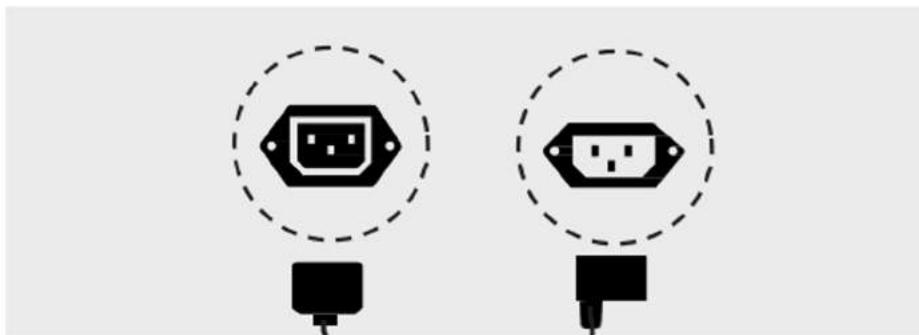

Step 2: Open switch

Power on the red switch and open the lead model black switch and see the display show word. If Connecting Multiple Light Units, the follow unit must close the black switch



Step 3: Connect Power Cables

Plug the power cord into the female socket of your therapy light. Next, plug the other end of the power cord into a wall socket. If only one unit ignore this step .

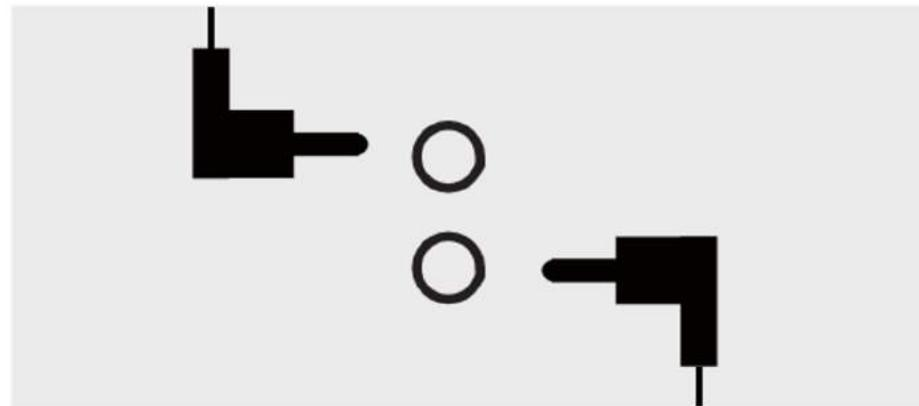

Step 4: Cooling Down

After each treatment session, your device's cooling fans will continue to work. This is to ensure that the LEDs are cooled properly and completely.

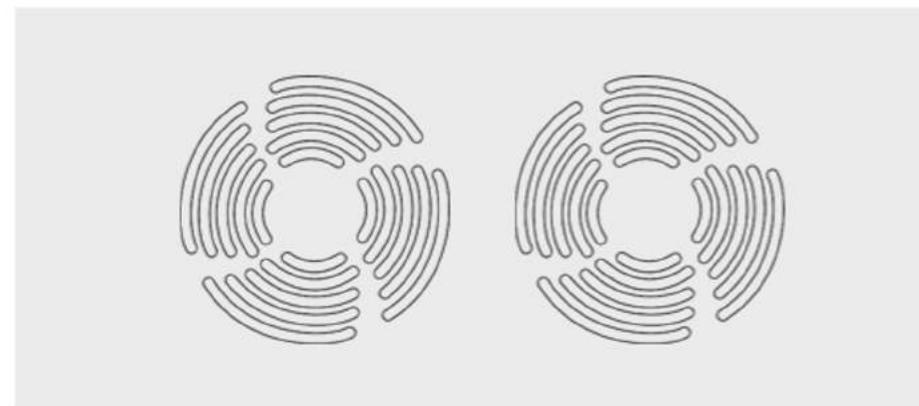



Step 1 **Step 2** **Step 3** **Step 4**

Setting Treatment Time

To adjust your treatment time, press the "T" button to select your desired treatment time. Then press 'OK', and the light is working.

Setting model

Press the "M" button on the control panel to select the wavelengths you want. You can choose red, display "R" or Near infrared, display "I". Or Both, that display "R I". Additionally, the red indicator lights below the control buttons will light up red to indicate which wavelength mode is selected. If Connecting Multiple Light Units, only set the lead model, and other units will follow. Press "OK", and your Sun Home Saunas model will start.

Step 1 **Step 2** **Step 3**

Your Light Settings



FREQUENTLY ASKED QUESTIONS

Q: How long should I use the device for?

A: Consistency and correct use are the keys to effective red light therapy. In order to use the RLT to achieve the best effects, please follow the following basic health benefits:

- Position yourself about 15cm away from the device
- Expose your skin for best results
- Approximately 10 minutes of treatment time per covered area, which can be used every day.

Q: Should I wear eye protection?

A: Eye protection is not required or necessary. However, we don't recommend looking directly at the LEDs because it can sometimes be uncomfortable. With that said, your eyes typically become accustomed to the light and it is then OK to open your eyes, as long as you don't feel uncomfortable.

Q: Why aren't the infrared LEDs working?

A: I can't see them. Near infrared (NIR) light is actually not visible to the naked human eye. It is outside of the visual spectrum, and as a result, it cannot be seen. However, there is a very slight glow that comes from the LEDs, especially in dark conditions, so if you are concerned the NIR LEDs are really not working, you can test them that way .

Q: When can I expect results?

A: Results vary depending on goals and treatment consistency. With that being said, many people will experience benefits such as increased muscle recovery, relief of pain and increased wound healing relatively quickly. However, more systemic benefits such as enhanced skin health, increased energy, improved hormonal health and increased quality of sleep may take 8-12 weeks of consistent use. Using your device every day will maximize the rate of response and healing. It is very important to be consistent with red light therapy.

Q: Does red light therapy interfere with the medications?

A: Red and near infrared light therapy has been proven in thousands of clinical studies and peer reviewed clinical trials to be not only safe but also effective. However, if you use medications such as Tetracycline, Digoxin, Retin A, and/or other photo sensitizing drugs, we recommend consulting with your doctor or health care provider before using the device.

Q: How long should I use the device for?

A: Position yourself about 20cm from the device. Expose your skin for best results. Approximately 10-20 minute treatment times per coverage area. Daily use is ideal, any time of day. 2 - 4 times one week, repeat on areas if desired. Use it for 6-8 weeks until results are felt .

Q: Can I wear clothing during my treatment sessions?

A: Of course, just make sure that the area that you're treating is completely exposed.

SAFETY INSTRUCTIONS, WARNINGS, AND DISCLAIMER3

To preserve the life and functionality of the device, always store it in a cool, dry place when possible. For proper use and safety, please be sure to read this manual and follow all instructions and do not do any of the following with the device:

- DO NOT let children use the device Without adult supervision.
- DO NOT use this device on infants.
- DO NOT let sleeping, disabled, or unconscious persons use the device.
- DO NOT exceed 20 minutes of use in one therapy session.
- DO NOT use your device on open, fresh wounds.
- DO NOT use in combination with liniments, salves, ointments, or balms that contain heat producing ingredients. A skin burn could be the result of doing so.
- DO NOT modify or attempt to repair This equipment. There are no parts that are serviceable by the user. The light is an electrical device. To avoid electric shock and other electricity-related dangers, adhere to the following instructions:
- DO NOT wash electrical parts with water or other liquids.
- DO NOT drop your device in water or other liquids or place it where it may fall into water or other liquids.
- Do NOT expose your device to running water. If your device comes into contact or becomes submerged into water or other liquid, unplug it immediately from the electrical power outlet. If the device is to be used in the vicinity of water, we recommend using an electrical outlet protected by Ground Fault Circuit Interrupter.
- DO NOT directly touch the device or touch the plugs or switches with wet hands.
- DO NOT apply or touch the device to, or with, wet or damp skin.
- DO NOT pull, carry, or lift the device by its cord. If the cord is damaged, don't use the device.
- DO NOT use on or near heated surfaces.
- DO NOT operate this device in areas Where it could be exposed to flammable or combustible products or vapours. Explosion of fire may occur.
- DO NOT store your device in hot temperatures exceeding 60 degrees Celsius.
- DO NOT use your device if it is damaged. Continuous use of a damaged device may result in electric shock or injury .
- DO NOT use extension cords unless they are designed to carry the total wattage of the device being powered.
- DO NOT unplug by pulling directly on the cord. Grasp the plug itself, not the cord, when unplugging from an outlet.
- DO NOT cover the cooling fans while Operating the device.

Cautions

We recommend that you consult your healthcare provider earlier if you think you may are sensitive to light. Some cold and allergy medications, painkillers and medications used to treat infections can cause light sensitivity. We also recommend that you consult your healthcare before using the device if you are pregnant, have a suspicion or cancer lesions, or have recently received a steroid injection or use topical steroids. If you experience discomfort or worry about the device, stop using immediately and contact your healthcare provider. Disconnect the outlet when not in use to avoid tripping hazards.

Disposal

The symbol on the right, which is on the device or in the packaging, indicates that the unit must not be disposed of with other household waste. This device requires disposal via a designated collection point for the recycling of electrical waste. Please recycle your disposal equipment to conserve natural resources and protect humans health and environment.

Disclaimer

This product is not intended to diagnose, cure or prevent any disease. We make no claims either guarantees regarding the ability of this product to cure something physical, skin or mental state from using this product. A qualified healthcare professional should always be consulted before using this product with respect to any conditions that require medical attention.

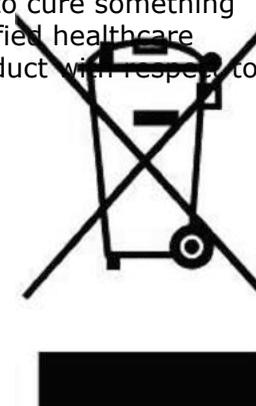

MAINTENANCE, CUSTOMER SERVICE, AND WARRANTY

Maintenance

The device requires no maintenance other than basic maintenance and regular cleaning. It is easy to clean the device, just unplug it and wipe the surface with a damp cloth or paper towel. Do not use harsh cleaning chemicals or bleach as they may damage the device. Make sure the device is dry before using it again. For safety reasons, the device is intended for indoor use only.

Customer Service

We are committed to your well-being by providing you with effective, efficient and affordable light therapy devices. If you have a problem with the device's light therapy device, or if you have any questions or concerns about the device, do not hesitate to contact **Sun Home Saunas** info@sunhomesaunas.com and we will be more than happy to answer your questions.

Warranty

We guarantee that the device works and performs within the specifications for 5 years after the delivery date. The 5 year warranty covers all parts during the warranty period with certain exceptions. If necessary, the buyer is responsible for returning the device to us within a 5 years warranty period. The warranty does not apply to any device that has been abused, misused, modified, damaged or equipped with spare parts other than manufactured parts. We are not responsible for losses or inconveniences caused by defects in our product. After the warranty has ended, the buyer is obliged to pay for all parts and labor costs. If the unit is repaired or replaced, either within or outside the warranty period, we reserve the right to provide parts or replace in colors other than the original unit. To get warranty service, please email us.



www.sunhomesaunas.com
info@sunhomesaunas.com

COPYRIGHT © 2022 SUN HOME SAUNAS.
ALL RIGHTS RESERVED.