

Thank you for purchasing the NE-C28P. This product was developed in conjunction with respiratory therapists for the successful treatment of asthma, chronic bronchitis, allergies and other respiratory disorders. This is a medical device. Operate the device only as instructed by your doctor and/or respiratory therapist.

How the nebulizer kit works

The medication that is pumped up through the medication channel is mixed with compressed air which is generated by a compressor pump. The compressed air mixed with medication is turned into fine particles and sprayed when in contact with the baffle.

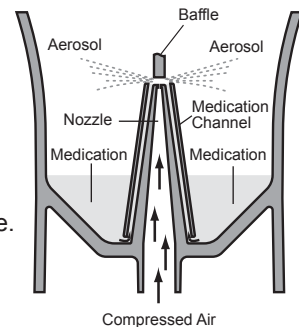

Nebulizer Kit with Virtual Valve Technology

The high efficiency Virtual Valve Technology (V.V.T.) reduces drug wastage while breathing out and maximizes drug availability when breathing in.

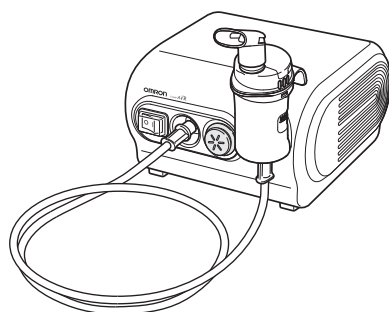

Compressor Nebulizer NE-C28P (NE-C28P-UK)

Instruction Manual

EN

| | |
|----------------------------|--|
| Manufacturer | OMRON HEALTHCARE Co., Ltd. 53, Kunotsubo, Terado-cho, Muko, KYOTO, 617-0002 JAPAN |
| EU-representative | OMRON HEALTHCARE EUROPE B.V. Scorpius 33, 2132 LR Hoofddorp, THE NETHERLANDS |
| Importer in EU | www.omron-healthcare.com |
| Production facility | OMRON DALIAN Co., Ltd. No. 3, Song Jiang Road, Economic and Technical Development Zone, Dalian 116600, China |
| OMRON Subsidiary | OMRON HEALTHCARE UK LTD. Opal Drive, Fox Milne, Milton Keynes, MK15 0DG, UK www.omron-healthcare.com |

Made in China

Important safety instructions

Read all the information in the instruction manual and any other literature included in the box before using the device.

Warning: Indicates a potentially hazardous situation which, if not avoided, could result in serious injury.

(Usage)

- For type, dose, and regime of medication follow the instructions of your doctor or respiratory therapist.
- If you experience any allergic reactions or other difficulties during use, stop using the device immediately and consult your doctor.
- Do not use only water in the nebulizer for inhaling purposes.
- Keep the device out of the reach of unsupervised infants and children. The device may contain small pieces that can be swallowed.
- Do not store the air tube while there is moisture or medication remaining inside.
- Do not use or store the device where it may be exposed to noxious fumes or volatile substances.
- Do not use the device where it may be exposed to flammable gas.
- Do not cover the compressor with a blanket, towel, or any other type of cover during use. The compressor could get hot and there is a possible risk of a burn if touched.
- Always dispose of any remaining medication after use, and use fresh medication each time.
- Do not use in anaesthetic or ventilator breathing circuits.
- Do not block the ventilation slots. Never place the device where the ventilation slots may be obstructed during operation. The compressor could get hot and there is a possible risk of a burn if touched.
- Store the parts in a clean location to avoid infection.

(Risk of electrical shock)

- Never plug or unplug the device with wet hands.
- The compressor and power cord are not waterproof. Do not spill water or other liquids on these parts. If liquid does spill on these parts, immediately unplug the power cord and wipe off the liquid with gauze or other absorbent material.
- Do not immerse the compressor in water or other liquid.
- Do not use or store the device in humid locations.
- Do not operate the device with a damaged power cord or plug.
- Keep the power cord away from heated surfaces.

(Cleaning and disinfecting)

Observe the rules below when cleaning or disinfecting parts. Failure to observe these rules may result in damage, inefficient nebulization or infection. For the instructions, refer to "Cleaning and disinfecting" section.

- Clean and disinfect the nebulizer kit, mask, mouthpiece or nosepiece before using them when as follows:
 - the first time after purchase
 - if the device has not been used for a long period of time
 - if more than one person uses the same device
- Be sure to wash or wipe the parts after use, and ensure that they are thoroughly disinfected and dried, and stored in a clean location.
- Do not leave the cleaning solution to dry on the parts.

Caution: Indicates a potentially hazardous situation which if not avoided, may result in minor or moderate injury, or physical damage.

(Usage)

- In order to prevent strangulation by the power cord or air tube, or injuries caused by mishandling, please provide close supervision when this device is used by, on, or near children or invalids.
- Make sure that the parts are attached correctly.
- Make sure that the air filter is correctly attached.
- Make sure that the air filter is clean. If the air filter has been used for more than 60 days, replace it with a new one.
- Do not tilt the nebulizer kit at an angle of greater than 45 degrees in all directions or shake it while in use.
- Do not use or store the device while the air tube is created.
- Use only original nebulizing parts, air tube, air filter and air filter cover.
- Do not add more than 7 ml of medication to the medication tank.
- Do not carry or leave the nebulizer kit while the medication tank contains medication.
- Do not leave the device unattended with infants or persons who cannot express their consent.
- Do not subject the device or the parts to any strong shocks such as dropping on the floor.
- Do not distort the vaporizer head, or jab the nozzle of the medication tank with a pin or any sharp object.
- Do not insert fingers or objects inside the compressor.
- Do not disassemble or attempt to repair the compressor or power cord.
- Do not leave the device or its parts in extreme hot or cold temperature, or under direct sunlight.
- Do not block the air filter cover.
- Do not use the device while sleeping or if drowsy.
- Approved for human use only.
- The compressor may become hot during operation.
- Do not touch the compressor for other than necessary operation such as turning off the power while nebulizing.
- To avoid the medication residue on the face, be sure to wipe the face after removing the mask.
- To avoid injury to the nose mucosa, do not squeeze the nosepiece into the back of the nose.
- Do not block the slit between the cap and the inhalation air inlet.
- Make sure that the vaporizer head is correctly installed before use.
- Do not use a damaged nebulizer kit, mouthpiece or nosepiece.
- While using this device, make sure that no mobile phone or any other electrical devices that emit electromagnetic fields is within 30cm. This may result in degradation of performance of the device.

(Risk of electrical shock)

- Always unplugging the device from the power outlet after use and before cleaning.
- Plug the device into the appropriate voltage outlet. Do not overload power outlets or use extension cords.
- Do not misuse the power cord.
- Do not wind the power cord around the compressor.
- Changes or modifications not approved by OMRON HEALTHCARE will void the user warranty.
- Do not pull the power cord strongly.

(Cleaning and disinfecting)

Observe the rules below when cleaning or disinfecting parts. Failure to observe these rules may result in damage, inefficient nebulization or infection. For the instructions, refer to "Cleaning and disinfecting" section.

- Do not use a microwave oven, dish dryer or hair dryer to dry the device or the parts.
- Do not use an autoclave, EOG gas sterilizer or low temperature plasma sterilizer.
- When disinfecting parts by boiling, make sure that the container does not boil dry. Otherwise it may also result in a fire.

General Safety Precautions:

- Inspect the device and parts before using them each time, and check that there are no problems. In particular, be sure to check the following:
 - That the vaporizer head, nozzle or air tube are not damaged.
 - That the nozzle is not blocked.
 - That the compressor operates normally.
- When using this device, there will be some noise and vibration caused by the pump in the compressor. There will also be some noise caused by the emission of compressed air from the nebulizer kit. This is normal and does not indicate a malfunction.
- Operate the device only as intended. Do not use the device for any other purpose.
- Do not use the device at temperatures greater than +40°C.
- Make sure that the air tube is securely attached to the compressor and nebulizer kit, and does not come loose. Twist the air tube plug slightly when inserting it into the air tube connectors to avoid the air tube disconnecting during use.
- To completely isolate the device from the power source unplug the plug from the power source.

Keep these instructions for future reference.

Important information regarding Electromagnetic Compatibility (EMC)
NE-C28P-UK manufactured by OMRON HEALTHCARE Co., Ltd. conforms to EN60601-1-2:2015 Electromagnetic Compatibility (EMC) standard. Further documentation in accordance with this EMC standard is available at OMRON HEALTHCARE EUROPE at the address mentioned in this instruction manual or at www.omron-healthcare.com. Refer to the EMC information for NE-C28P-UK on the website.



Correct Disposal of This Product (Waste Electrical & Electronic Equipment)

This marking shown on the product or its literature, indicates that it should not be disposed of, with other household wastes at the end of its working life. To prevent possible harm to the environment or human health from uncontrolled waste disposal, please separate this product from other types of wastes and recycle it responsibly to promote the sustainable reuse of material resources. Household users should contact either the retailer where they purchased this product, or their local government office, for details of where and how they can return this item for environmentally safe recycling. Business users should contact their supplier and check the terms and conditions of the purchase contract. This product should not be mixed with other commercial waste for disposal.

Optional Medical Accessories

| Product description | Model |
|--|---------------|
| V.V.T. Nebulizer Kit N-01 & Mouthpiece Set | NEB-NSET3-81E |
| Adult Mask (PVC) | NEB-MSLP-E |
| Child Mask (PVC) | NEB-MSMP-E |
| Adult Mask (SEBS) | NEB-MSLS-E |
| Child Mask (SEBS) Set | NEB-MSSS-E |
| Mouthpiece | NEB-MP-E |
| Nosepiece | NEB-NP-E |
| Air Tube (PVC, 200cm) | NEB-TP-L20E |
| Air Tube (Silicone, 100cm) | NEB-TSC-L10E |

Other Optional/Replacement Parts

| Product description | Model |
|---------------------|-------------|
| Air Filters x 5 | NEB-AFR-28E |

How to use

Warning:

- Clean and disinfect the nebulizer kit, mask, mouthpiece or nosepiece before using them when as follows:
 - the first time after purchase
 - if the device has not been used for a long period of time
 - if more than one person uses the same device
- For the instructions, refer to "Cleaning and disinfecting" section.

1. Make sure that the power switch is in the off () position.

2. Plug the power plug into a power outlet.

Note: Do not place the device in a location where it is difficult to disconnect the power cord.

3. Remove the cap and the inhalation top from the medication tank.

4. Add the correct amount of prescribed medication to the medication tank.

5. Make sure that the vaporizer head is securely attached to the inhalation top.

6. Put the inhalation top back inside the medication tank.

7. Attach the cap and mask, mouthpiece or nosepiece to the nebulizer kit tightly.

Note:
It is not necessary to attach the cap when nebulizing with Adult mask. If the amount of aerosol is too great, attach the cap.

8. Attach the air tube. Twist the air tube plug slightly and push it firmly into the air tube connector.

9. Hold the nebulizer kit as indicated on the right.

Follow the instructions of your doctor or respiratory therapist.

Caution:

Do not tilt the nebulizer kit at an angle of greater than 45 degrees in all directions. Medication may flow into the mouth or it may result in not nebulizing effectively.

10. Press the power switch to the on () position. As the compressor starts, nebulization begins and aerosol is generated. Inhale the medication.

11. When treatment is complete, turn the power off and unplug the compressor from the power outlet.

All for Healthcare

IM-NE-C28P-UK-EN-04-03/2020
1679307-2D
Issue Date: 2020-04-08

Intended use

Medical Purpose

This product is intended to be used for inhaling medication for respiratory disorders.

Intended User

- Legally certified medical experts, such as doctor, nurse and therapist.
- Caregiver or patient under the guidance of qualified medical experts for home treatment.
- The user should also be capable of understanding general operation of NE-C28P and the content of instruction manual.

Intended Patients

This product should not be used on patients, who are unconscious or are not breathing spontaneously.

Environment

This product is intended for use in a medical facility, such as Hospital, clinic and doctor's office, and in a room of general household.

Durable period

Durable periods are as follows, provided the product is used to nebulize saline 3 times a day for 10 minutes each time at room temperature (23°C).

Durable period may vary depending on usage environment.

Frequent use of the product may shorten the durable period.

| | |
|------------------------|---------|
| Compressor (Main unit) | 5 years |
| Nebulizer Kit | 1 year |
| Mouthpiece | 1 year |
| Nosepiece | 1 year |
| Air Tube (PVC, 200cm) | 1 year |
| Air Filter | 60 days |
| Masks (PVC)/(SEBS) | 1 year |

Precautions for use

Warnings and cautions described in the instruction manual should be observed.

Know your unit

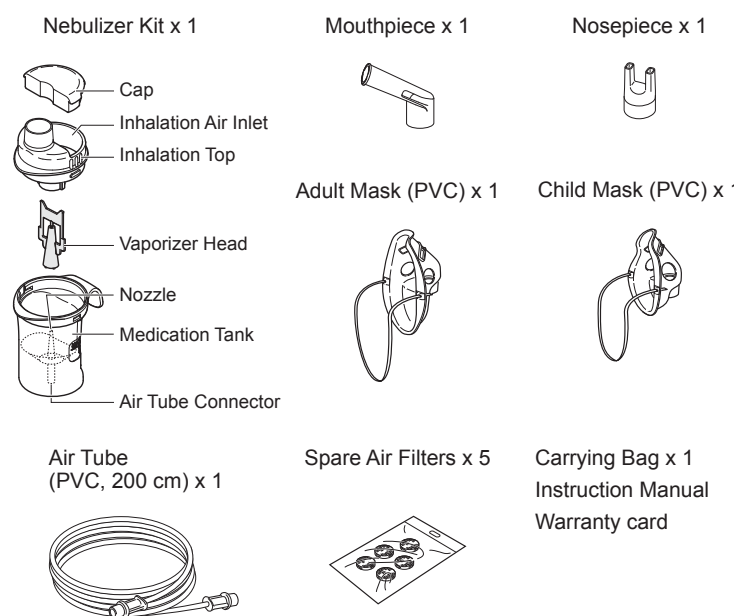
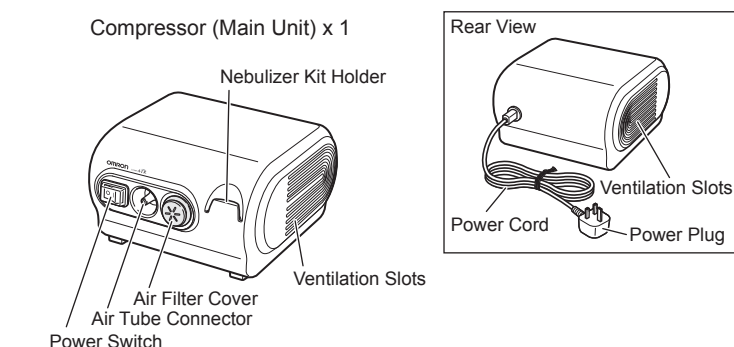

Cleaning and disinfecting

⚠ Caution: Handling the Vaporizer Head

- Always wash the vaporizer head after each use.
- Do not use a brush or pin to clean the vaporizer head.
- When disinfecting the parts by boiling, be sure to boil them in plenty of water.
- Do not boil vaporizer head together with objects other than applicable nebulizer accessories.

Cleaning

Clean the parts after each use to remove residual medication. This will avoid inefficient nebulization or infection.

- Washable parts
- Nebulizer Kit, Masks (PVC)/(SEBS), Mouthpiece, Nosepiece, Air Tube (Silicone)**

Wash in warm water and mild detergent (neutral detergent). Rinse thoroughly with clean hot tap water and allow to air dry in a clean place.

• Vaporizer Head

Wash it with running water.

■ Non-washable parts

- Compressor, Air Tube (PVC)**

Firstly, make sure that the power plug is unplugged from the power outlet. Wipe clean with a soft cloth moistened with water or mild detergent (neutral detergent).

• Air Filter

Do not wash or clean the air filter. If the air filter becomes wet, replace it. Damp air filters can cause blockages.

Disinfecting

Always disinfect the parts after the last treatment of the day. If the parts are heavily stained, replace them with new ones.

To select a method for disinfection, refer to the table below.

○: applicable X: not applicable

| Disinfecting method | Parts | Mouthpiece | Nosepiece | Nebulizer Kit | Air Tube (Silicone, 100 cm) (optional) | Adult Mask (SEBS) (optional) | Child Mask (SEBS) (optional) | Adult Mask (PVC) (optional) | Child Mask (PVC) (optional) | Air Tube (PVC, 200 cm) | Air Filter |
|---------------------|---|------------|-----------|-------------------------|--|--|--|-----------------------------|-----------------------------|------------------------|------------|
| | Materials | PP | PP | PP (Vaporizer Head: PC) | Tube: Silicone Connector: PP | Mask: SEBS Band: Rubber*** Adapter: PP | Mask: PVC (Phthalate free) Band: Rubber*** | PVC (Phthalate free) | Polyester | | |
| A | Alcohol Disinfecting ethanol | ○ | ○ | ○ | ○ | ○** | ○** | ○** | X | X | |
| | Sodium hypochlorite (Milton* (0.1%, 15 min.)) | ○ | ○ | ○ | ○ | ○** | ○** | ○** | X | X | |
| B | Boiling | ○ | ○ | ○ | ○ | ○** | X | X | X | X | |

* an example of commercially available disinfectant. (The concentration and residence time specified in the table are under the conditions where the service life of the parts is tested with each disinfectant used as described in its instruction manual. Please note that the testing was not performed for the purpose of ensuring the effectiveness of the disinfectants. There is no intention of suggesting that such disinfectants be used. Conditions of use and ingredients of disinfectant vary for manufacturers. Please read the instruction manuals carefully before use and apply disinfectant to each part in an appropriate way. Please notice that service life of the parts may be shorter depending on conditions, environments and frequency of use.)

** Remove the rubber band from mask before disinfecting.

*** The band is not made with natural rubber latex.

A. Use a commercially available disinfectant. Follow the instructions provided by the disinfectant manufacturer.

Note: Never clean with benzene, thinner or a flammable chemical.

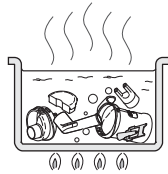

B. Parts may be boiled between 15 to 20 minutes.

After boiling, carefully remove the parts, shake off excess water and allow to air dry in a clean environment.

Removing condensation from the air tube

If there is moisture or liquid remaining in the air tube, be sure to follow the procedure below to remove any moisture from within the air tube.

- 1) Make sure that the air tube is connected to the air connector on the compressor.
- 2) Remove the air tube from the nebulizer kit.
- 3) Turn on the compressor and pump air through the air tube to expel the moisture.

Changing the air filter

If the air filter has been used for more than 60 days, replace it with a new one.

1. Pull the air filter cover off the compressor.

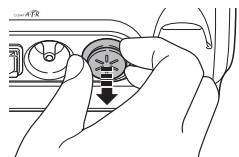

2. Change the air filter.

Remove the old air filter with a sharp object and insert the new air filter.

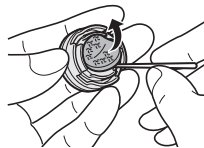

3. Put the air filter cover back in place. Make sure it is attached properly.

Notes:

- Use only OMRON air filters designed for this device. Do not operate without a filter.
- Do not wash or clean the filter. If the air filter becomes wet, replace it. Damp air filters can cause blockages.
- There is no front or back orientation for the air filters.
- Check that air filters are clean and free of dust before inserting them.

Troubleshooting

In case of any of the below problems occur during use, first check that no other electrical device is within 30cm. If the problem persists, please refer to the table below.

| Problem | Cause | Remedy |
|---|---|--|
| Nothing happens when the power switch is pressed. | Is the power plug plugged into a power outlet? | Check that the plug is inserted in a power outlet. Unplug then reinsert the plug if necessary. |
| No nebulization or low nebulization rate, when the power is on. | Is there medication in the medication tank? | Add the correct amount of medication to the medication tank. |
| | Is there too much/little medication in the medication tank? | |
| | Is the vaporizer head missing or not assembled correctly? | Attach the vaporizer head correctly. |
| | Is the nebulizer kit assembled correctly? | Assemble the nebulizer kit correctly. |
| | Is the nozzle blocked? | Make sure that the nozzle is free of blockages. |
| | Is the nebulizer kit tilted at a sharp angle? | Make sure that the nebulizer kit is not tilted at an angle of more than 45 degrees. |
| Is the air tube connected correctly? | Make sure that the air tube is correctly connected to the compressor and nebulizer kit. | |
| Is the air tube folded or damaged? | Make sure that the air tube does not contain kinks. | |
| Is the air tube blocked? | Make sure that the air tube is free of blockages. | |
| Is the air filter dirty? | Replace the air filter with a new one. | |
| The compressor is abnormally loud. | Is the air filter cover attached correctly? | Attach the air filter cover correctly. |
| The compressor is very hot. | Is the compressor covered? | Do not cover the compressor with any type of cover during use. |
| | Are the ventilation slots blocked? | Do not block the ventilation slots. |

Note: If the suggested remedy does not solve the problem, do not try to repair the device - no parts of the device are user serviceable. Return the device to an authorized OMRON retail outlet or distributor.

Technical data

| | |
|--|---|
| Product Category: | Nebulizers |
| Product Description: | Compressor Nebulizer |
| Model (code): | NE-C28P (NE-C28P-UK) |
| Rating: | 220 - 230V ~ 50Hz |
| Power Consumption: | 192VA |
| Operation Mode: | Continuous Use |
| Operating Temperature/Humidity: | +10°C to +40°C / 30% to 85%RH (non-condensing) / 700 to 1060 hPa |
| Storage and Transport Temperature/Humidity/Air Pressure: | -20°C to +60°C / 10% to 95%RH (non-condensing) / 700 to 1060 hPa |
| Weight: | Approx. 1.7 kg (compressor only) |
| Dimensions: | Approx. 170 (W) × 103 (H) × 182 (D) mm |
| Contents: | Compressor, Nebulizer Kit, Air Tube (PVC, 200 cm), Mouthpiece, Nosepiece, Adult Mask (PVC), Child Mask (PVC), 5 pcs Spare Air Filters, Carrying Bag, Instruction Manual, Warranty Card. |

Classification: Class II (Protection against electric shock), Type BF (Applied part; Mask, Mouthpiece, Nosepiece) IP21 (Ingress Protection)

CE0197

Technical data for the OMRON NE-C28P Compressor with the V.V.T. Nebulizer Kit N-01:

Particle Size: **MMAD Approx. 3 μm
MMAD = Mass Median Aerodynamic Diameter

Medication Tank Capacity: 7 ml maximum

Appropriate Medication Quantities: 2 ml minimum - 7 ml maximum

Sound: *Less than 60dB

Nebulization Rate: *Approx. 0.5 ml/min (by weight loss)

Aerosol Output: **0.4 ml (2 ml, 1% NaF)

Aerosol Output Rate: **0.09 ml/min (2 ml, 1% NaF)

Result of cascade impactor measurements for particle size**

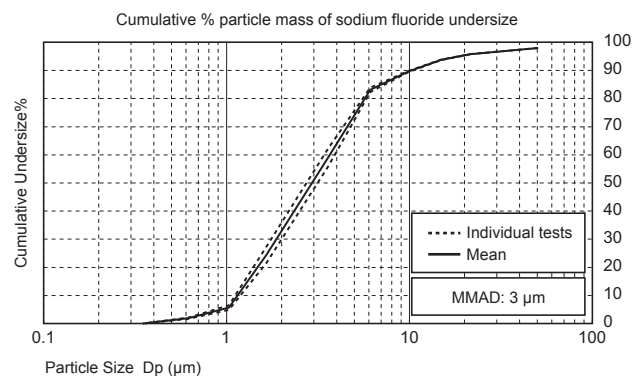

* Measured by OMRON HEALTHCARE Co., Ltd.

** Independently measured by Prof. Dr. Hiroshi Takano, Department of Chemical Engineering and Materials Science, Faculty of Science and Engineering, Doshisha University, Kyoto, Japan, according to EN 13544-1:2007+A1:2009.

Notes:

- Subject to technical modification without prior notice.
- This OMRON product is produced under the strict quality system of OMRON HEALTHCARE Co., Ltd., Japan.
- The device may not work if the temperature and voltage conditions are different to those defined in the specifications.
- If the device is stored at the maximum or minimum storage and transport temperature and is moved to an environment with a temperature of 20°C, we recommend waiting for approximately 2 hours before using the device.
- The device fulfils the provisions of the European Standard EN13544-1:2007+A1:2009, Respiratory therapy equipment - Part1: Nebulizing systems and their components.
- Performance may vary with medication such as suspensions or high viscosity. See medication supplier's data sheet for further details.
- See website of OMRON HEALTHCARE EUROPE to update technical information. URL: www.omron-healthcare.com
- IP classification is degrees of protection provided by enclosures in accordance with IEC 60529. The compressor is protected against solid foreign objects of 12.5 mm diameter and greater such as a finger, and against vertically falling water drops which may cause issues during a normal operation.
- Please report to the manufacturer and the competent authority of the Member State in which you are established about any serious incident that has occurred in relation to this device.

| Symbols description | |
|---------------------|---|
| | Need for the user to consult the instructions for use |
| | Applied part - Type BF Degree of protection against electric shock (leakage current) |
| | Class II Protection against electric shock |
| IP XX | Ingress protection degree provided by IEC 60529 |
| | CE Marking |
| | Serial number |
| | Medical device |
| | Date of manufacture |
| | Temperature limitation |
| | Humidity limitation |
| | Atmospheric pressure limitation |
| | Power OFF or Stand-by |
| | Power ON |
| | Alternating current |
| | Trademark of OMRON compressor nebulizers (COMP A-I-R, COMP A-I-R basic, COMP A-I-R Elite, COMP A-I-R Pro) |