

## BF511 (HBF-511T-E/HBF-511B-E) Body Composition Monitor

- Instruction Manual
- Mode d'emploi
- Gebrauchsanweisung
- Manuale di istruzioni
- Manual de instrucciones
- Gebruiksaanwijzing
- РУКОВОДСТВО ПО ЭКСПЛУАТАЦИИ

• كتيب الإرشادات

EN

FR

DE

IT

ES

NL

RU

AR

Thank you for purchasing the OMRON Body Composition Monitor.  
Before using this unit for the first time, please be sure to read this Instruction Manual carefully and use the unit safely and properly.  
Please keep this Instruction Manual at hand all the time for future reference.

# BF511(HBF-511T-E/HBF-511B-E) Body Composition Monitor

Dear customer,

Thank you for purchasing this high-quality OMRON Body Composition Monitor. With this medical device you will be able to precisely measure the following body composition parameters and immediately interpret the results:

- Body Fat (in %)
- Visceral Fat (up to 30 levels)
- Body Mass Index (BMI)
- Skeletal Muscle (in %)

In addition, the calculation of the Resting Metabolism Rate (in kcal) determines the daily calorie requirement and can act as a reference for weight reduction programme.

The unique OMRON 8-sensor technology using both hands and feet provides one of the most accurate methods of entire body measurements.

The OMRON Body Composition Monitor BF511 is suitable for children from 6 years onwards and adults and can weigh persons up to 150 kg.  
This unit is intended to be operated by adults who can understand this instruction manual.



Please read this instruction manual carefully before use and for further information on the individual functions.

Please keep this manual for future reference. Do not use this unit for purposes other than described in this manual.

## Contents

### Before using the unit

Notes on Safety .....	2
Information on Body Composition .....	3

### Operating instructions

1. Know Your Unit .....	5
2. Inserting and Replacing the Batteries .....	5
3. Setting and Storing Personal Data .....	6
4. Taking a Measurement .....	8
5. Measuring Weight Only .....	12



### Care and maintenance

6. Error Displays .....	13
7. Troubleshooting .....	13
8. How to Take Care of and Store the Unit .....	14
9. Technical Data .....	15

EN

## Notes on Safety

Symbols and definitions are as follows:

 <b>Danger:</b>	Improper use may cause danger resulting in death or serious injury.
 <b>Warning:</b>	Improper use may result in possible death or serious injury.
 <b>Caution:</b>	Improper use may result in injury or property damage.

### **Danger:**

• Never use this unit in combination with medical electronic devices such as:

- (1) Medical electronic implants such as pacemakers.
- (2) Electronic life support systems such as an artificial heart/lung.
- (3) Portable electronic medical devices such as an electrocardiograph.



This unit could cause these devices to malfunction, posing a considerable health risk to users of these devices.

### **Warning:**

- Never start weight reduction or exercise therapy without the instructions of a doctor or specialist.
- Do not use the unit on slippery surfaces, such as a wet floor.
- Keep the unit out of the reach of young children. Contains small parts that may cause a choking hazard if swallowed by infants.
- The cord of the display may cause accidental strangulation in infants.
- Do not jump onto the unit, or hop up and down on the unit.
- Do not use this unit when your body and/or feet are wet, such as after taking a bath.
- Stand on the main unit bare-footed. Attempting to stand on it with socks on may cause you to slip and result in injury.
- Do not step on the edge or display area of the main unit.
- People with disabilities, or who are physically frail, should always be assisted by another person when using this unit. Use a handrail or so when stepping on the unit.
- If battery fluid should get in your eyes, immediately rinse with plenty of clean water. Consult a doctor immediately.
- When the device malfunctions, it may get hot. Areas with a possible rise in temperature:
  - (1) Around the battery compartment area: 105°C (max.)
  - (2) The electrodes and operation buttons: 48°C (max.)
 If the device malfunctions and does not operate, stop using it immediately. Do not apply the electrodes or keep touching the operation buttons for 10 minutes or more.

### **Caution:**

- This unit is intended for home use only. It is not intended for professional use in hospitals or other medical facilities.
- Do not disassemble, repair, or remodel the display unit or the main unit.

- During measurement, make sure that no mobile phone or any other electrical devices that emit electromagnetic fields is within 30cm of this device. This may result in incorrect operation of the device and/or cause an inaccurate reading.
- Take care when storing the display unit. Your fingers may be trapped between the grip and the main unit if you press it too strongly.
- Do not use batteries not specified for this unit. Do not insert the batteries with the polarities in the wrong direction.
- Replace worn batteries with new ones immediately.
- Do not dispose of batteries in fire.
- If battery fluid should get on your skin or clothing, immediately rinse with plenty of clean water.
- Remove the batteries from this unit when you are not going to use it for a long period of time (approximately three months or more).
- Do not use different types of batteries together.
- Do not use new and worn batteries together.
- Remove the display unit from main unit before stepping on the unit. If you try to remove the display unit while stepping on to the unit, you may lose your balance and fall.

### **General Advice:**

- Do not place this unit on a cushioned floor surface such as on a carpet or a mat. Correct measurement may not be possible.
- Do not place this unit in highly humid environments and protect it from splashing water.
- Do not place this unit near heat sources or below air conditioners and avoid direct sunlight.
- Do not use this unit for purposes other than described in this manual.
- Do not pull the cord of the display unit attached to the main unit with force.
- As this unit is a precision instrument, do not drop, vibrate, or apply strong shock.
- Disposal of used batteries should be carried out in accordance with the national regulations for the disposal of batteries.
- Do not wash the display unit or the main unit with water.
- Do not wipe the unit with benzene, gasoline, paint thinner, alcohol, or other volatile solvents.
- Do not place this unit where it will be exposed to chemicals or corrosive vapors.
- Use the battery within recommended period mentioned to it.

Read and follow the "Important information regarding Electro Magnetic Compatibility (EMC)" in the Technical Data Section.

# Information on Body Composition

## Principle of body composition calculation

### **Body fat has low electric conductivity**

The BF511 measures the body fat percentage by the Bioelectrical Impedance (BI) method. Muscles, blood vessels and bones are body tissues with a high water content that conducts electricity easily. Body fat is tissue that has little electric conductivity. The BF511 sends an extremely weak electrical current of 50 kHz and less than 500  $\mu$ A through your body to determine the amount of fat tissue. This weak electrical current is not felt while operating the BF511.

In order for the scale to determine body composition, it uses the electrical impedance, along with your height, weight, age and gender information to generate results based on OMRON's data of body composition.

### **Measures the whole body to avoid the influence of fluctuations**

During the course of a day, the amount of water in the body tends to gradually shift to the lower limbs. This is why there is a tendency for the legs and ankles to swell in the evening or at night. The ratio of water in the upper body and lower body is different in the morning and evening, and this means that the electrical impedance of the body also varies. Since the BF511 uses electrodes for both hands and feet to take measurements, it can reduce the influence of these fluctuations on measurement results.

### **Recommended measurement times**

Understanding the normal changes in your body fat percentage can help you in preventing or reducing obesity. Being aware of the times when the body fat percentages shift within your own daily schedule will assist you in obtaining an accurate trending of your body fat. It is recommended to use this unit in the same environment and daily circumstances. (See chart)

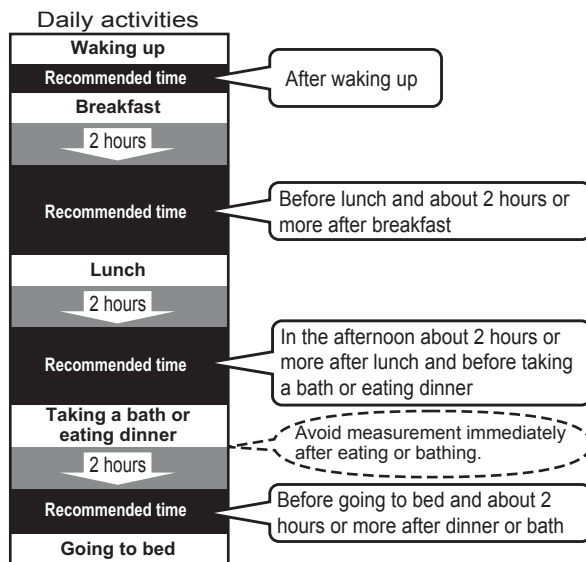

### **Avoid Taking Measurements Under the Following Conditions:**

- Immediately after vigorous exercise, after a bath or sauna.
- After drinking alcohol or a large amount of water, after a meal (about 2 hours).

If a measurement is taken under these physical conditions, the calculated body composition may differ significantly from the actual one because the water content in the body is changing.

## What is BMI (Body Mass Index)?

BMI uses the following simple formula to indicate the ratio between weight and height of a person.

$$\text{BMI} = \text{weight (kg)} / \text{height (m)} / \text{height (m)}$$

The OMRON BF511 uses the height information stored in your personal profile number or when entering information in the Guest Mode to calculate your BMI classification.

If the fat level revealed by BMI is higher than the international standard, there is an increased likelihood of common diseases. However, not all types of fat can be revealed by BMI.

## What is Body Fat Percentage?

Body fat percentage refers to the amount of body fat mass in regards to the total body weight expressed as a percentage.

$$\text{Body fat percentage (\%)} = \{\text{Body fat mass (kg)} / \text{Body weight (kg)}\} \times 100$$

The device uses BI method to estimate your body fat percentage.

Depending on where fat is distributed in the body, it is classified as visceral fat or subcutaneous fat.

## What is Visceral Fat Level?

### **Visceral fat = fat surrounding internal organs**

Too much visceral fat is thought to be closely linked to increased levels of fat in the bloodstream, which can lead to common diseases such as hyperlipidemia and diabetes, which impairs the ability of insulin to transfer energy from the bloodstream and using it in cells. In order to prevent or improve conditions of common diseases, it is important to try and reduce visceral fat levels to an acceptable level. People with high visceral fat levels tend to have large stomachs. However, this is not always the case and high visceral fat levels can lead to metabolically obese. Metabolically obese (visceral obesity with normal weight) represents fat levels that are higher than average, even if a person's weight is at or below the standard for their height.

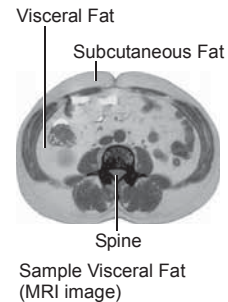

## What is Subcutaneous Fat?

### **Subcutaneous fat = fat below the skin**

Subcutaneous fat not only accumulates around the stomach but also around the upper arms, hips and thighs, and can cause a distortion of the body's proportions. Although not directly linked to increased risk of disease, it is thought to increase pressure on the heart and other complications. Subcutaneous fat is not displayed in this unit, but is included in the body fat percentage.

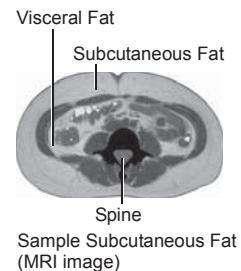

## What is Skeletal Muscle?

Muscle is divided into two types, muscle in internal organs, such as the heart, and skeletal muscle attached to bones that is used to move the body. Skeletal muscle can be increased through exercise and other activity. Increasing the ratio of skeletal muscle means that body can burn energy more easily, which means that it is less likely to turn to fat, and makes it easier to lead an energetic lifestyle.

## What is Resting Metabolism?

Regardless of your activity level, a minimum level of caloric intake is required to sustain the body's everyday functions. Known as the resting metabolism, this indicates how many calories you need to ingest in order to provide enough energy for your body to function.

### ***The reason calculated results may differ from actual body fat percentage***

The body fat percentage measured by this unit may significantly differ from the actual body fat percentage in the following situations:

Elderly people (over 81 years old) / People with a fever / Body builders or highly trained athletes / Patients undergoing dialysis / Patients with osteoporosis who have very low bone density / Pregnant women / People with swelling

These differences may be related to changing ratios of body fluid and/or body composition.

# 1. Know Your Unit

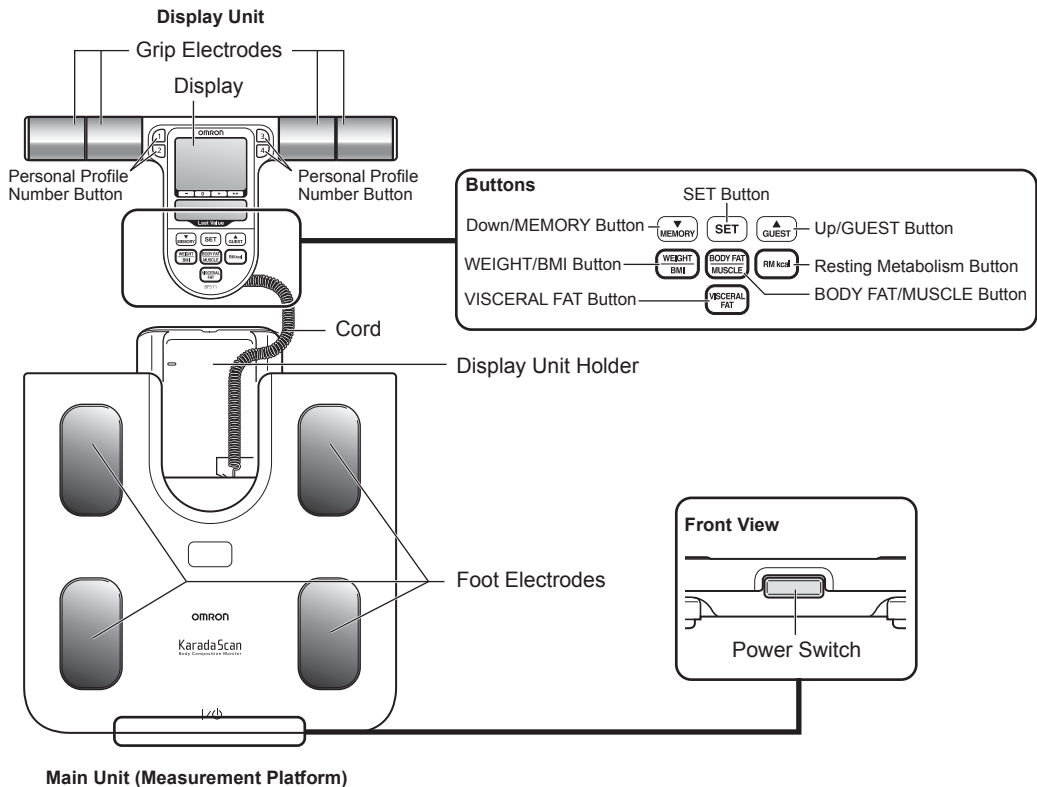

# 2. Inserting and Replacing the Batteries

1. Open the battery cover on the back of the main unit.

- 1) Press the tab of the battery cover to release it.
- 2) Pull it up as shown.

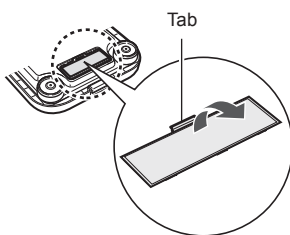

2. Install the batteries in correct polarity as marked inside the battery compartment.

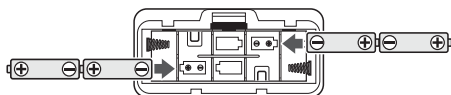

3. Close the battery cover.

## Battery Life and Replacement

When the battery low indicator (  ) appears, replace all four batteries with new ones.

Items stored in memory are retained even if the batteries are removed.

- Replace the batteries after turning off the power.
- Disposal of used batteries should be carried out in accordance with the national regulations for the disposal of batteries.
- Four AA batteries will last approximately 1 year (when measurements are made four times a day).
- Because the supplied batteries are for trial use only, they may have a shorter life.

### 3. Setting and Storing Personal Data

For the measurement of body composition, it is necessary to set your personal data (age, gender, height).

#### 1. Turn on the power.

"CAL" blinks on the display, then the display changes to "0.0 kg".



\* Wait until "0.0 kg" is displayed.

#### 2. Press the Personal Profile Number button to select your personal profile number.

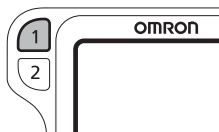

1) The selected number blinks on the display.



2) Press the SET button to confirm. Then the default age setting blinks on the display.



#### 3. [TO SET THE AGE]

Setting range: 6 to 80 years old

1) Press the ▲ or ▼ button to adjust the age.



2) Press the SET button to confirm. Then the gender icons blink on the display.



#### 4. [TO SET THE GENDER AND HEIGHT]

Set the gender (MALE) or (FEMALE) and height in the same way.

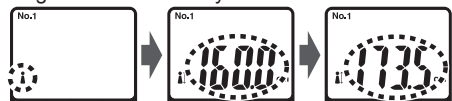

After all the settings are displayed for your confirmation, "0.0 kg" appears on the display.

This completes the setting.

#### Selecting Measurement Unit

You can change the measurement units used for the height and weight settings.

#### 1. Turn on the power.

"CAL" blinks on the display, then the display changes to "0.0 kg".  
Wait until "0.0 kg" appears on the display.

#### 2. Keep the ▼ button pressed until "lb" and "kg" blink on the display.



#### 3. Press the ▲/▼ button to select "kg" or "lb".

This will also automatically change "cm" and "in".

#### 4. Press the SET button to confirm.

All height and weight measurements are displayed using the new measurement units. The change remains in effect until you change it again.

**Changing the Personal Data****1.** Turn on the power.

"CAL" blinks on the display, then the display changes to "0.0 kg".  
Wait until "0.0 kg" appears on the display.

**2.** Press the Personal Profile Number button to select your personal profile number.

**1)** Your number flashes one time on the display.

**2)** Press the SET button to confirm.

Then the selected age setting blinks on the display.

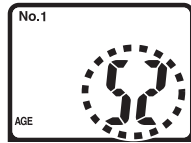
**3.** With the ▲ or ▼ button, modify the selected item, followed by pressing SET button. The display will change in order of age, gender and height.**Deleting the Personal Data****1.** Turn on the power.

"CAL" blinks on the display, then the display changes to "0.0 kg".  
Wait until "0.0 kg" appears on the display.

**2.** Press the Personal Profile Number button to select your personal profile number.

**1)** Your number flashes one time on the display.

**2)** Press the SET button to confirm.

Then the selected age setting blinks on the display.

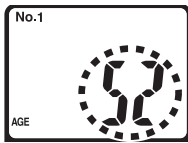
**3.** Delete the personal data.

Press the Personal Profile Number button for more than two seconds.

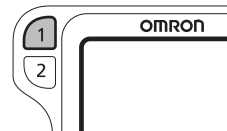

"Clr" will appear on the display and the personal data are deleted from memory.

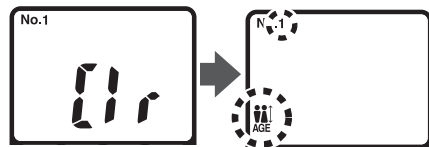
**Power Switch**

The power will automatically switch off in the following conditions:

1. If the monitor is not used within one minute of "0.0 kg" appearing on the display.
2. If no information is entered for 5 minutes when entering personal data.
3. If the monitor is not used for 5 minutes after the measurement results are displayed.
4. Five (5) minutes after the result is displayed when measuring weight only.



## 4. Taking a Measurement

Measurement should be taken on a level and hard surface.

### 1. Turn on the power.

"CAL" blinks on the display, then the display changes to "0.0 kg".



\* If you step onto the unit before "0.0 kg" appears on the display, an error message "Err" will appear.

### 2. When the "0.0 kg" is displayed, take out the display unit.

**Note:** Do not take out the display unit until "0.0 kg" appears on the display. Otherwise, the weight of the display is added to your body weight which causes an incorrect result.

### 3. Select the personal profile number.

Press the Personal Profile Number button while holding the display unit. Selected number will appear after blinking once.

**If the following display is indicated:**



Your personal data is not stored in the personal profile number you have selected. Please see Section 3 to store personal data.

**If you do not have personal data stored on the unit (GUEST mode):**

- 1) Press the GUEST button while holding the display unit.
- 2) The GUEST indication "G" appears on the display.
- 3) Set the personal data (age, gender, and height). Read steps 3 through 4 in Section 3, Setting and Storing Personal Data.

### 4. Start measurement.

- 1) Step on the main unit and place your feet on the foot electrodes with your weight evenly distributed.

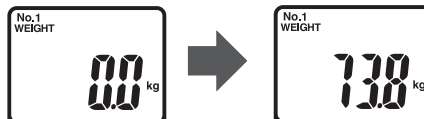

The display will show your weight and then the weight result will blink twice. The unit will then start to measure your body fat percentage, visceral fat level, skeletal muscle percentage, BMI and resting metabolism.

- 2) When "START" appears on the display, extend your arms straight at a 90° angle to your body.

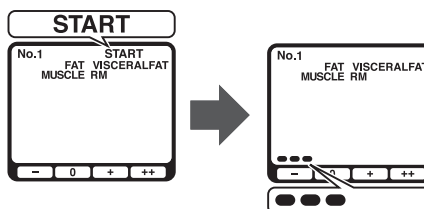

The indicators in the measurement progress bar at the bottom of the display will gradually appear, from left to right.

- 3) After the measurement is complete, your weight is displayed again. At this point you may step off the unit.



**Correct Posture for Measurement**

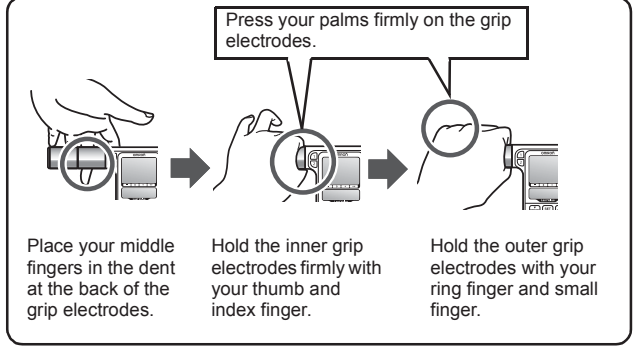
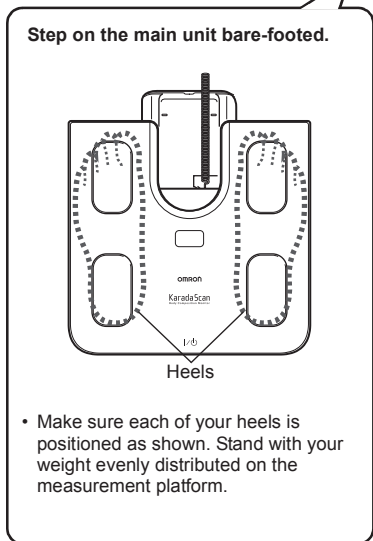
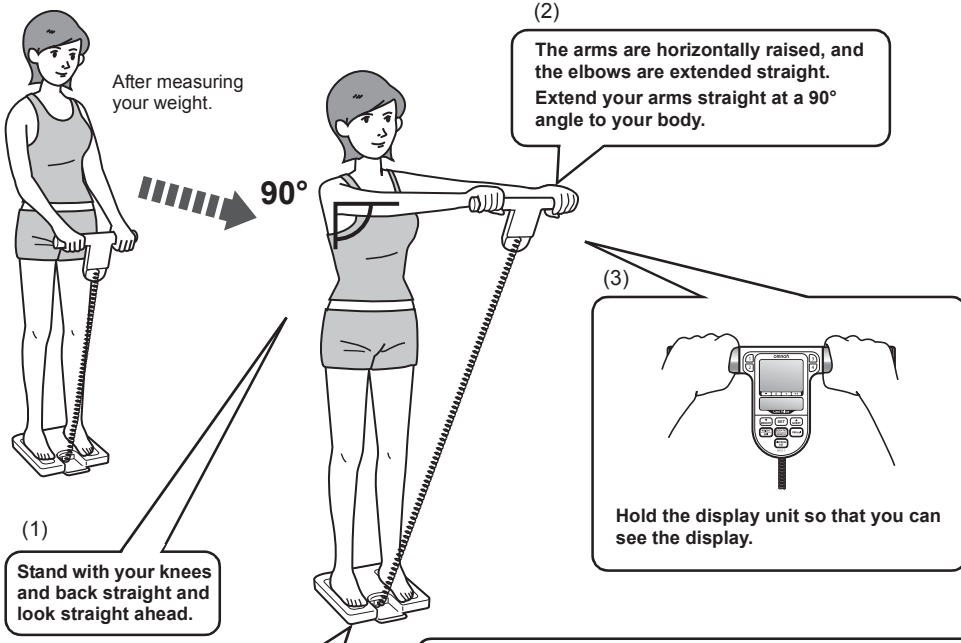

**Postures to Avoid During Measurement**

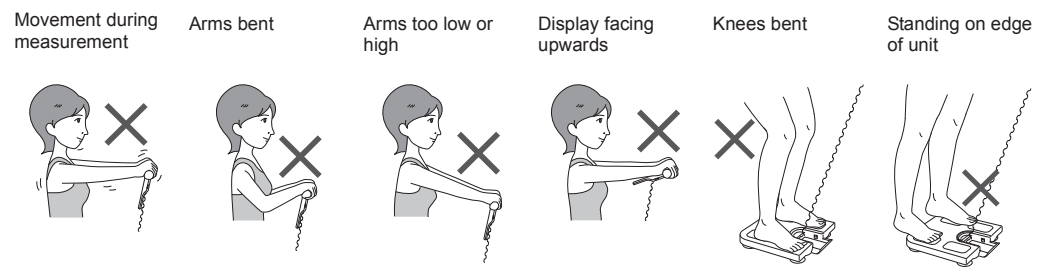

EN

5. Check the measurement results.

Press the appropriate button to view the desired measurement results. Last values of the previous measurement are shown in the Last Value area of the display.

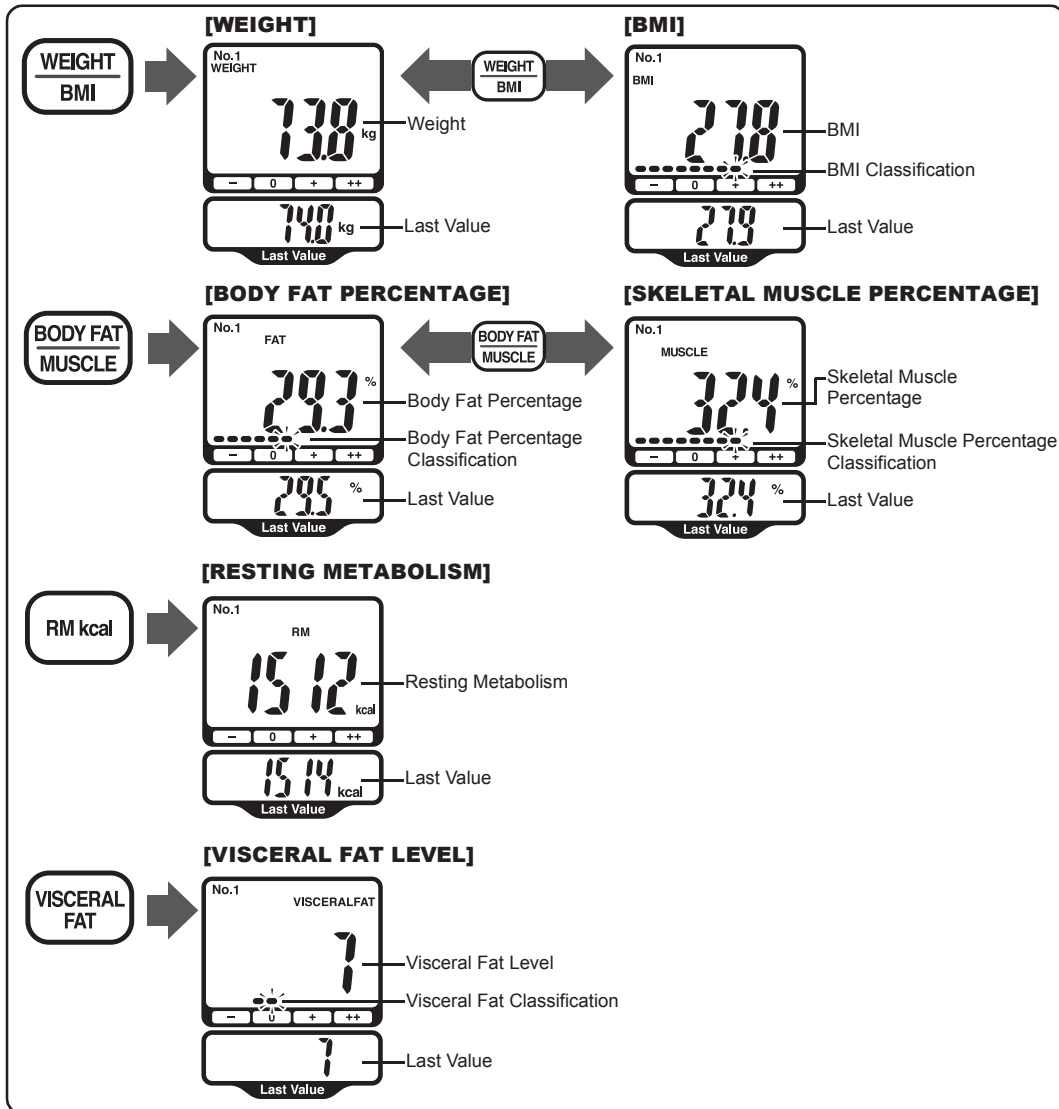

**Note:** For children (6 to 17 years old), this unit displays weight, body fat percentage classification, skeletal muscle percentage, BMI and BMI classification and resting metabolism.

### Interpreting the Body Fat Percentage Result

The table below is based on research by HD McCarthy et al, in the International Journal of Obesity, Vol. 30, 2006, and by Gallagher et al., American Journal of Clinical Nutrition, Vol. 72, Sept. 2000, and classified into four levels by Omron Healthcare.

Gender	Age	- (Low)	0 (Normal)	+ (High)	++ (Very High)
Female	6	< 13.8%	13.8 - 24.9%	25.0 - 27.0%	≥ 27.1%
	7	< 14.4%	14.4 - 27.0%	27.1 - 29.6%	≥ 29.7%
	8	< 15.1%	15.1 - 29.1%	29.2 - 31.9%	≥ 32.0%
	9	< 15.8%	15.8 - 30.8%	30.9 - 33.8%	≥ 33.9%
	10	< 16.1%	16.1 - 32.2%	32.3 - 35.2%	≥ 35.3%
	11	< 16.3%	16.3 - 33.1%	33.2 - 36.0%	≥ 36.1%
	12	< 16.4%	16.4 - 33.5%	33.6 - 36.3%	≥ 36.4%
	13	< 16.4%	16.4 - 33.8%	33.9 - 36.5%	≥ 36.6%
	14	< 16.3%	16.3 - 34.0%	34.1 - 36.7%	≥ 36.8%
	15	< 16.1%	16.1 - 34.2%	34.3 - 36.9%	≥ 37.0%
	16	< 15.8%	15.8 - 34.5%	34.6 - 37.1%	≥ 37.2%
	17	< 15.4%	15.4 - 34.7%	34.8 - 37.3%	≥ 37.4%
	18 - 39	< 21.0%	21.0 - 32.9%	33.0 - 38.9%	≥ 39.0%
	40 - 59	< 23.0%	23.0 - 33.9%	34.0 - 39.9%	≥ 40.0%
60 - 80	< 24.0%	24.0 - 35.9%	36.0 - 41.9%	≥ 42.0%	
Male	6	< 11.8%	11.8 - 21.7%	21.8 - 23.7%	≥ 23.8%
	7	< 12.1%	12.1 - 23.2%	23.3 - 25.5%	≥ 25.6%
	8	< 12.4%	12.4 - 24.8%	24.9 - 27.7%	≥ 27.8%
	9	< 12.6%	12.6 - 26.5%	26.6 - 30.0%	≥ 30.1%
	10	< 12.8%	12.8 - 27.9%	28.0 - 31.8%	≥ 31.9%
	11	< 12.6%	12.6 - 28.5%	28.6 - 32.6%	≥ 32.7%
	12	< 12.3%	12.3 - 28.2%	28.3 - 32.4%	≥ 32.5%
	13	< 11.6%	11.6 - 27.5%	27.6 - 31.3%	≥ 31.4%
	14	< 11.1%	11.1 - 26.4%	26.5 - 30.0%	≥ 30.1%
	15	< 10.8%	10.8 - 25.4%	25.5 - 28.7%	≥ 28.8%
	16	< 10.4%	10.4 - 24.7%	24.8 - 27.7%	≥ 27.8%
	17	< 10.1%	10.1 - 24.2%	24.3 - 26.8%	≥ 26.9%
	18 - 39	< 8.0%	8.0 - 19.9%	20.0 - 24.9%	≥ 25.0%
	40 - 59	< 11.0%	11.0 - 21.9%	22.0 - 27.9%	≥ 28.0%
60 - 80	< 13.0%	13.0 - 24.9%	25.0 - 29.9%	≥ 30.0%	

EN

### Interpreting the Visceral Fat Level Result

Visceral Fat Level	Level Classification
1 - 9	0 (Normal)
10 - 14	+ (High)
15 - 30	++ (Very High)

According to Omron Healthcare figures

### Interpreting the BMI Result

BMI	BMI (Designation by the WHO)	BMI Classification Bar				BMI Rating
		-	0	+	++	
BMI < 18.5	- (Underweight)	■				7.0 - 10.7 10.8 - 14.5 14.6 - 18.4
18.5 ≤ BMI < 25	0 (Normal)	■■■	■■■			18.5 - 20.5 20.6 - 22.7 22.8 - 24.9
25 ≤ BMI < 30	+ (Overweight)	■■■■■	■■■■■	■■■		25.0 - 26.5 26.6 - 28.2 28.3 - 29.9
30 ≤ BMI	++ (Obese)	■■■■■■■	■■■■■■■	■■■■■	■■■	30.0 - 34.9 35.0 - 39.9 40.0 - 90.0

The above-mentioned indices refer to the values for obesity judgment proposed by WHO, the World Health Organization.

### Interpreting the Skeletal Muscle Percentage Result (for adults)

Gender	Age	- (Low)	0 (Normal)	+ (High)	++ (Very High)
Female	18-39	< 24.3%	24.3 - 30.3%	30.4 - 35.3%	≥ 35.4%
	40-59	< 24.1%	24.1 - 30.1%	30.2 - 35.1%	≥ 35.2%
	60-80	< 23.9%	23.9 - 29.9%	30.0 - 34.9%	≥ 35.0%
Male	18-39	< 33.3%	33.3 - 39.3%	39.4 - 44.0%	≥ 44.1%
	40-59	< 33.1%	33.1 - 39.1%	39.2 - 43.8%	≥ 43.9%
	60-80	< 32.9%	32.9 - 38.9%	39.0 - 43.6%	≥ 43.7%

According to Omron Healthcare figures

## 6. After confirmation of the results, turn off the power.

**Note:** If you forget to turn off the power, the unit will be turned off automatically after 5 minutes. Return the display unit to the holder on the main unit as illustrated in Section 8.

## 5. Measuring Weight Only

### 1. Turn on the power.

"CAL" blinks on the display, then the display changes to "0.0 kg".



**Note:** If you step onto the unit before "0.0 kg" appears on the display, an error message "Err" will appear.

### 2. When the "0.0 kg" is displayed, step onto the unit.

**Note:** Leave the display unit in the display unit holder.

### 3. Check the measurement result.

Your weight is displayed and blinks twice to indicate that measurement is completed.

**Note:** At this stage you can also check the measurement result by taking out the display unit.

### 4. When the measurement is completed, step down from the unit and turn off the power.

## 6. Error Displays

Error Display	Cause	Correction
<b>Err 1</b>	Your palms or soles are not in firm contact with the electrodes.	Press your palms or soles firmly to the electrodes, then measure. (Refer to Section 4.)
<b>Err 2</b>	The posture for measurement is wrong or the palms or soles are not in firm contact with the electrodes.	Measure without moving the hands or soles. (Refer to Section 4.)
<b>Err 3</b>	The palms or soles are too dry.	Moisten the palms or soles with a wet towel, then repeat measurement.
<b>Err 4</b>	Values of body composition are out of measurable range.	<ul style="list-style-type: none"> <li>• Please ensure that age, gender and height settings stored as personal data are correct. (Refer to Setting Items in Section 9.)</li> <li>• The main unit cannot measure body composition outside its measurement range, even if the Age, Gender and Height settings are correct.</li> </ul>
<b>Err 5</b>	Abnormal operation.	Insert the batteries again and repeat measurement. If this error still occurs, consult your OMRON service representative.
<b>Err</b>	You stepped on the unit before the display indicated "0.0 kg".	Step on the main unit after the display indicates "0.0 kg".
	You moved the main unit before the display indicated "0.0 kg".	Do not move the main unit until the display indicates "0.0 kg".
	You moved your body while measuring body weight.	Do not move while measuring body weight.
	Your weight is 150 kg (330.0 lb) or over.	Body weight of 150 kg (330.0 lb) or over is out of the measuring range of this unit. You cannot use this unit.

## 7. Troubleshooting

In case of any if the below problems occur during measurement, first check that no other electrical device is within 30cm.

If the problem persists, please refer to the table below.

Problem	Cause	Correction
The displayed value of body composition is abnormally high or low.	Refer to "Information on Body Composition".	
The power turns off approximately 5 minutes after the body weight is confirmed and before your body fat percentage, visceral fat level, skeletal muscle percentage, BMI and resting metabolism is measured.	You did not select the correct personal profile number or the GUEST mode. (The personal profile number or "G" is not displayed on the display unit.)	Select the correct personal profile number or the GUEST mode. (Refer to Section 4.)
Nothing is displayed when the power is turned on.	Batteries are not inserted.	Insert the batteries.
	The polarities of batteries are not aligned correctly.	Insert the batteries in correct alignment.
	The batteries are worn out.	Replace all four batteries with new ones. (Refer to Section 2.)
	The cord connecting the main unit and the display unit is damaged or worn.	Contact the nearest OMRON service representative.

## 8. How to Take Care of and Store the Unit

### *How to Clean the Unit*

- Always keep the unit clean before use.
- Wipe the main unit with a soft dry cloth.  
If necessary, use a cloth moistened with water or detergent and squeeze it well before wiping the unit, then wipe dry with a dry cloth.
- You can use cleaning alcohol to clean the electrodes, but do not use it on other parts of the unit.
- Do not use benzene or thinner, to clean the unit.

### *Care and Storage*

- Store the display unit in the main unit as shown.
- When storing the display unit, be careful not to crease the cord.

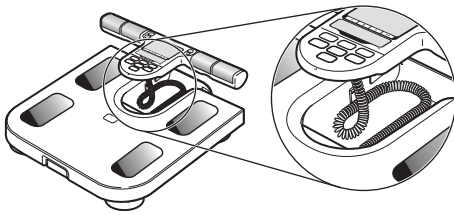

- Do not store the unit in the following conditions:
  - Humidity, where moisture or water may get into the unit
  - High temperatures, direct sunlight or dusty places
  - Places with the risk of sudden shocks or vibrations
  - In places where chemicals are stored or where corrosive gas is present.
- Do not carry out repairs of any kind yourself. This product is calibrated at the time of manufacture. If at any time you question the accuracy of measurements, please contact your authorized OMRON distributor. In general it is recommended to have the device inspected every 2 years to ensure correct functioning and accuracy.

## 9. Technical Data

<b>Product Category</b>	<b>Body Composition Analyzers</b>	
<b>Product Description</b>	Body Composition Monitor	
<b>Model (Code)</b>	<b>BF511 (HBF-511T-E/HBF-511B-E)</b>	
<b>Display</b>	<b>Body Weight:</b>	0 to 150 kg with an increment of 0.1 kg (0.0 to 330.0 lb with an increment of 0.2 lb)
	<b>Body Fat percentage:</b>	5.0 to 60.0% with an increment of 0.1%
	<b>Skeletal Muscle percentage:</b>	5.0 to 50.0% with an increment of 0.1%
	<b>BMI:</b>	7.0 to 90.0 with an increment of 0.1
	<b>Resting Metabolism:</b>	385 to 3999 kcal with an increment of 1 kcal
	<b>Visceral Fat Level:</b>	30 levels with an increment of 1 level
	<b>BMI classification:</b>	- (Underweight) / 0 (Normal) / + (Overweight) / ++ (Obese) 4 levels with 3 sublevels each
	<b>Body fat percentage and Skeletal muscle percentage classification:</b>	- (Low) / 0 (Normal) / + (High) / ++ (Very High) 4 levels with 3 sublevels each
	<b>Visceral fat level classification:</b>	0 (Normal) / + (High) / ++ (Very High) 3 levels with 3 sublevels each
<b>Setting Items</b>	<b>Height:</b>	100.0 to 199.5 cm (3' 4" to 6' 6 3/4")
	<b>Age:</b>	6 to 80 years old
	<b>Gender:</b>	Male/Female
		* Measurement Units: kg (cm) / lb (feet•inch)
		* The age range for the Body Fat percentage, Body Fat percentage classification, Skeletal Muscle percentage, BMI and BMI classification and Resting Metabolism rate is 6 to 80 years old.
		* The age range for Visceral Fat level, Visceral Fat level classification and Skeletal Muscle percentage classification is 18 to 80 years old.
<b>Weight Accuracy</b>	<b>0.0 kg to 40.0 kg:</b>	± 0.4 kg (0.0 lb to 88.2 lb: ± 0.88 lb)
	<b>40.0 kg to 150.0 kg:</b>	± 1% (88.2 lb to 330.0 lb: ± 1%)
<b>Accuracy (S.E.E.)</b>	<b>Body Fat percentage:</b>	3.5%
	<b>Skeletal Muscle percentage:</b>	3.5%
	<b>Visceral Fat Level:</b>	3 levels
<b>Durable Period</b>	5 years	
<b>Power Supply</b>	4 AA batteries (R6) (You may also use AA alkaline batteries (LR6).)	
<b>Battery Life</b>	Approximately 1 year (when manganese batteries are used with four measurements a day)	
<b>Operating Temperature / Humidity / Air Pressure</b>	+10 to 40°C / 30 to 85% RH (non-condensing) / 700 to 1060 hPa	
<b>Storage and Transport Temperature / Humidity / Air Pressure</b>	-20 to 60°C / 10 to 95% RH (non-condensing) / 700 to 1060 hPa	
<b>Protection Against Electric Shock</b>	Internally powered ME equipment	
<b>Applied Part</b>	Type BF (Grip Electrodes, Foot Electrodes)	
<b>IP Classification</b>	IP21	
	*IP classification is degrees of protection provided by IEC 60529.	
	This unit is protected against solid foreign objects of diameter 12.5mm such as a finger and greater. This unit is protected against the ingress of vertically falling water drips.	
<b>Weight</b>	Approximately 2.2 kg (4.85 lb) (including batteries)	
<b>External Dimensions</b>	<b>Display unit:</b>	Approx. 300 (W) × 35 (H) × 147 mm (D) (Approx. 11 3/4" (W) × 1 3/8" (H) × 5 3/4" (D))
	<b>Main unit:</b>	Approx. 303 (W) × 55 (H) × 327 mm (D) (Approx. 11 7/8" (W) × 2 1/8" (H) × 12 7/8" (D))
<b>Package Contents</b>	Body Composition Monitor, 4 AA manganese batteries (R6), instruction manual, Guarantee Card	







**Note:** Subject to technical modification without prior notice.

# CE0197

This device fulfills the provisions of the EC directive 93/42/EEC (Medical Device Directive).

EN



Description of symbols that, depending on a model, can be found on the product itself, product sales package or IM			
	Applied part - Type BF Degree of protection against electric shock (leakage current)		Temperature limitation
<b>IP XX</b>	Ingress protection degree provided by IEC 60529		Humidity limitation
<b>CE</b>	CE Marking		Atmospheric pressure limitation
<b>SN</b>	Serial number		Direct current
	Need for the user to consult the instructions for use		This product should not be used by persons with medical implants, e.g. heart pacemakers, artificial heart, lung or other electronic life support systems.
Product production date is integrated in a Serial number, which is placed on the Rating Label and sales package: the first 4 digits mean year of production, the next 2 digits - month of production.			



***Correct Disposal of this Product  
(Waste Electrical & Electronic Equipment)***

This marking shown on the product or its literature, indicates that it should not be disposed with other household wastes at the end of its working life. To prevent possible harm to the environment or human health from uncontrolled waste disposal, please separate this from other types of wastes and recycle it responsibly to promote the sustainable reuse of material resources.

Household users should contact either the retailer where they purchased this product, or their local government office, for details of where and how they can take this item for environmentally safe recycling.

Business users should contact their supplier and check the terms and conditions of the purchase contract. This product should not be mixed with other commercial wastes for disposal.

This product does not contain any hazardous substances.

Disposal of used batteries should be carried out in accordance with the national regulations for the disposal of batteries

***Important information regarding Electro Magnetic Compatibility (EMC)***

This device manufactured by OMRON HEALTHCARE Co., Ltd. conforms to EN60601-1-2:2015 Electro Magnetic Compatibility (EMC) standard.

Further documentation in accordance with this EMC standard is available at OMRON HEALTHCARE EUROPE at the address mentioned in this instruction manual or at [www.omron-healthcare.com](http://www.omron-healthcare.com)

<b>Manufacturer</b> 	<b>OMRON HEALTHCARE Co., Ltd.</b> 53, Kunotsubo, Terado-cho, Muko, KYOTO, 617-0002 JAPAN
<b>EU-representative</b> 	<b>OMRON HEALTHCARE EUROPE B.V.</b> Scorpius 33, 2132 LR Hoofddorp, THE NETHERLANDS www.omron-healthcare.com
<b>Production facility</b>	<b>Krell Precision (Yangzhou) Co., Ltd.</b> No.28, Xingyang Road, Economic Development Zone, Yangzhou, Jiangsu 225009, China
<b>Subsidiaries</b>	<b>OMRON HEALTHCARE UK LTD.</b> Opal Drive, Fox Milne, Milton Keynes, MK15 0DG, UK www.omron-healthcare.com
	<b>OMRON MEDIZINTECHNIK HANDELSGESELLSCHAFT mbH</b> Gottlieb-Daimler-Strasse 10, 68165 Mannheim, GERMANY www.omron-healthcare.com
	<b>OMRON SANTÉ FRANCE SAS</b> 14, rue de Lisbonne, 93561 Rosny-sous-Bois Cedex, FRANCE www.omron-healthcare.com

Made in China

