

# QUICK START GUIDE



Outdoor Collection

## WELCOME TO U-LINE

Congratulations on your U-Line purchase. Your product comes from a company with over five decades of premium modular ice making, refrigeration, and wine preservation experience. U-Line continues to be the American leader, delivering versatility and flexibility for multiple applications including residential, light commercial, outdoor and marine use. U-Line's complete product collection includes Wine Captain® Models, Beverage Centers, Clear Ice Machines, Nugget Ice Machines, Crescent Ice Makers, Glass & Solid Door Refrigerators, Drawer Models, Freezers, Combo® Models, and more.

U-Line has captivated those with an appreciation for the finer things with exceptional functionality, style, inspired innovations and attention to even the smallest details. We are known and respected for our unwavering dedication to product design, quality and selection. U-Line is headquartered in Milwaukee, Wisconsin and has shipped product to five continents for over two decades and is proud to have the opportunity to ship to you.

## PRODUCT INFORMATION

Looking for additional information on your product? User Guides, Spec Sheets, CAD Drawings, Compliance Documentation, and Product Warranty information are all available for reference and download at [u-line.com](http://u-line.com).

## PROPERTY DAMAGE / INJURY CONCERNS

In the unlikely event property damage or personal injury is suspected related to a U-Line product, please take the following steps:

1. U-Line Customer Care must be contacted immediately at +1.800.779.2547.
2. Service or repairs performed on the unit without prior written approval from U-Line is not permitted. If the unit has been altered or repaired in the field without prior written approval from U-Line, claims will not be eligible.

## GENERAL INQUIRIES

U-Line Corporation  
8900 N. 55th Street  
Milwaukee, Wisconsin 53223 USA  
Monday - Friday 8:00 am to 4:30 pm CST  
T: +1.414.354.0300  
F: +1.414.354.7905  
Email: [sales@u-line.com](mailto:sales@u-line.com)  
[u-line.com](http://u-line.com)

## SERVICE & PARTS ASSISTANCE

Monday - Friday 8:00 am to 4:30 pm CST  
T: +1.800.779.2547  
F: +1.414.354.5696  
Service Email: [onlineservice@u-line.com](mailto:onlineservice@u-line.com)  
Parts Email: [onlineparts@u-line.com](mailto:onlineparts@u-line.com)

## CONNECT WITH US



Designed, engineered and assembled in WI, USA

**This Quick Start Guide covers the basics of installation and general use of your product.**

## CONTENTS

Safety and Warning	4
Environmental Requirements	5
Electrical	5
Water Hookup	6
Drain	9
Door Swing	10
Door Adjustments	11
General Installation	17
Control Operation	18
First Use	22
Ice	23
Cleaning	26
Warranty	30

**For more details, see the complete User Guide & Service Manual on [u-line.com](http://u-line.com).**



This product is eligible for an additional one-year warranty at no charge when you register your product on [u-line.com](http://u-line.com). See complete warranty for details.

## Safety and Warning

**Please read all instructions before installing, operating, or servicing the appliance.**

Use this appliance for its intended purpose only and follow these general precautions with those listed throughout this guide:

### SAFETY ALERT DEFINITIONS

Throughout this guide are safety items labeled with a Danger, Warning or Caution based on the risk type:



#### **DANGER**

**Danger means that failure to follow this safety statement will result in severe personal injury or death.**



#### **WARNING**

**Warning means that failure to follow this safety statement could result in serious personal injury or death.**



#### **CAUTION**

**Caution means that failure to follow this safety statement may result in minor or moderate personal injury, property or equipment damage.**



#### **DANGER**

**Your product may contain R600a (Isobutane) which is a flammable hydrocarbon. To confirm, check serial tag inside of unit. It is safe for regular use. Do not use sharp objects to expedite defrosting. Do not service without consulting the “R600a specifications” section included in the User Guide. Do not damage the refrigerant circuit.**



#### **WARNING**

**Service must be done by factory authorized service personnel. Any parts shall be replaced with like components. Failure to comply could increase the risk of possible ignition due to incorrect parts or improper service.**

### CALIFORNIA PROPOSITION 65

**This product contains chemicals known to the state of California to cause cancer and birth defects or other reproductive harm.**

**[www.P65warnings.CA.gov](http://www.P65warnings.CA.gov)**

## Environmental Requirements

This unit is designed to operate between 50°F (10°C) and 100°F (38°C). Higher ambient temperatures may reduce the unit's ability to reach low temperatures and/or reduce ice production on applicable models.

For best performance, keep the unit out of direct sunlight and away from heat generating equipment.

In climates where high humidity and dew points are present, condensation may appear on outside surfaces. This is considered normal. The condensation will evaporate when the humidity drops.

 **CAUTION**

**Damages caused by ambient temperatures of 40°F (4°C) or below are not covered by the warranty.**

## Electrical

 **WARNING**

**SHOCK HAZARD – Electrical Grounding Required. Never attempt to repair or perform maintenance on the unit until the electricity has been disconnected.**

**Never remove the round grounding prong from the plug and never use a two-prong grounding adapter.**

**Altering, cutting or removing power cord, removing power plug, or direct wiring can cause serious injury, fire, loss of property and/or life, and will void the warranty.**

**Never use an extension cord to connect power to the unit.**

**Always keep your working area dry.**

**Electrical installation must observe all state and local codes. This unit requires connection to a grounded (three-prong), polarized receptacle that has been placed by a qualified electrician.**

The unit requires a grounded and polarized 115 VAC, 60 Hz, 15A power supply (normal household current). An individual, properly grounded branch circuit or circuit breaker is recommended. A GFCI (ground fault circuit interrupter) is usually not required for fixed location appliances and is not recommended for your unit because it could be prone to nuisance tripping. However, be sure to consult your local codes.

## Water Hookup

### PREPARE PLUMBING

The water valve uses a standard 1/4" (6.35 mm) compression fitting. U-Line recommends using accessory water hook up kit – part # 80-54674-00. The kit includes a 10' (3 m) braided flexible water supply line and a brass hose fitting.

**CAUTION**

**Plumbing installation must observe all state and local codes. All water and drain connections MUST BE made by a licensed/qualified plumbing contractor. Failure to follow recommendations and instructions may result in damage and/or harm.**

### Water Supply Connection

When connecting the water supply, please note the following:

- Before installing the unit and connecting to the cold water supply, review the local plumbing codes.
- The water pressure should be between 20 and 120 psi (138 and 827 kPa).
- The water line MUST have a shut-off valve in the supply line.
- The water line should be looped into 2 coils. This will allow the unit to be removed for cleaning and servicing. Make certain that the tubing is not pinched or damaged during installation.

**WARNING**

**Connect to potable water supply only.**

**CAUTION**

**Do not use any plastic water supply line. The line is under pressure at all times. Plastic may crack or rupture with age and cause damage to your home.**

**Do not use tape or joint compound when attaching a braided flexible water supply line that includes a rubber gasket. The gasket provides an adequate seal – other materials could cause blockage of the valve.**

**Failure to follow recommendations and instructions may result in damage and/or harm, flooding or void the product warranty.**

**Use new hose set. Do not reuse old hose set.**

**CAUTION**

**Turn off water supply and disconnect electrical supply to unit prior to installation.**

**Use caution when handling back panel. The edges could be sharp.**

### CRESCENT ICE MAKERS

1. Turn off water supply and disconnect electrical supply to product prior to attempting installation.
2. Remove the back panel.

3. Locate water valve inlet.

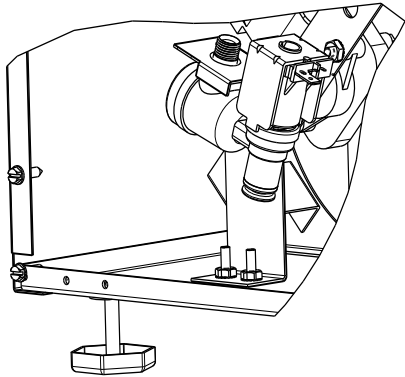

4. Break away filler feature in bushing with flat screwdriver.

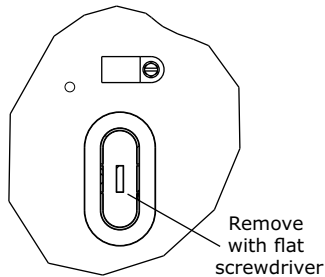

5. Thread water line through back panel hole (with bushing).

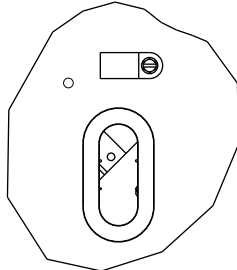

6. Locate water valve inlet and connect to valve.

7. Turn on water supply and check for leaks.

8. Reinstall back panel.

9. Install retaining clip.

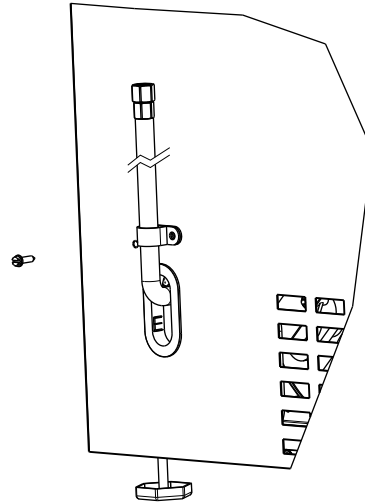

## CLEAR ICE MACHINES

1. Turn off water supply and disconnect electrical supply to product prior to attempting installation.
2. Remove the grille/access panel in the front and the back panel.
3. Locate water valve in the front of the unit and thread water supply line through.

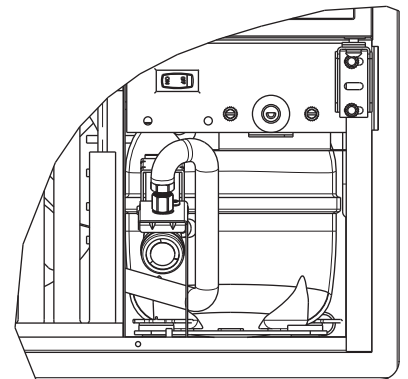

**Route the water supply line through the unit so it does not come into contact with any internal components other than the solenoid valve. Normal operation creates some vibration. A water supply line contacting an internal component or cabinet wall can cause excessive noise during operation or damage to the line.**

4. On the back panel, break away filler feature in bushing with flat screwdriver.

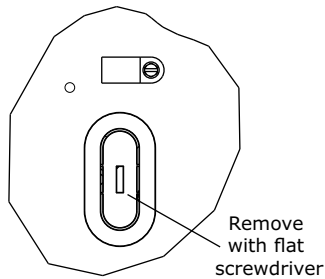

5. Thread water line through back panel hole (with bushing) and connect to cold water supply line.

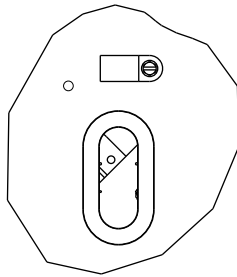

3. Thread water line through back panel hole (with bushing).

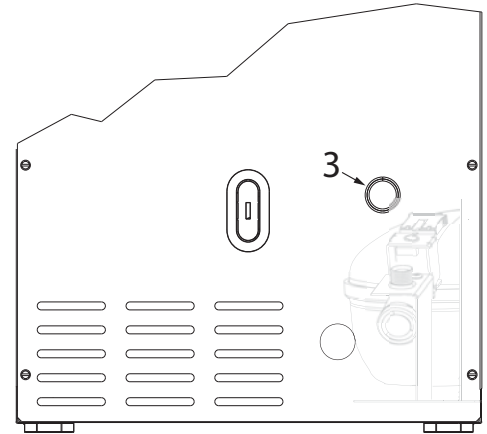

6. Turn on water supply and check for leaks.
7. Reinstall back panel and grille/front access panel.

8. Install retaining clip.

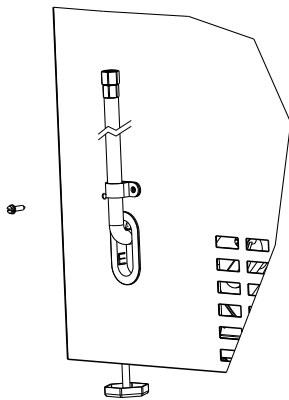

4. Locate water valve inlet and connect to valve.

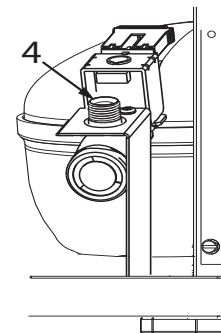

5. Turn on water supply and check for leaks.
6. Reinstall back panel.

## NUGGET ICE MACHINES

1. Turn off water supply and disconnect electrical supply to product prior to attempting installation.
2. Remove the back panel.



## Drain

### CLEAR ICE AND NUGGET ICE MACHINES ONLY

Model numbers including "CL" or "NB" do not include a factory installed drain pump.

Model numbers including "CP" or "NP" include a factory installed drain pump.

### DRAIN CONNECTION



**If your U-Line unit did not come with a factory installed drain pump you must use a gravity style drain connection. For assistance in determining if your unit has a pump please contact U-Line. The floor drain must be large enough to accommodate drainage from all attached drains. Follow these guidelines when installing drain lines to prevent water from flowing back into the ice maker storage bin and/or potentially flowing onto the floor, which may result in personal injury or property damage.**

**Drain can NOT be located directly below the unit. Unit has a solid base that will not allow the unit to drain below itself.**

**There is a possibility that hose connections may have loosened during shipment.**

**Verify all connections and fittings are free from leaks.**

### GRAVITY DRAIN

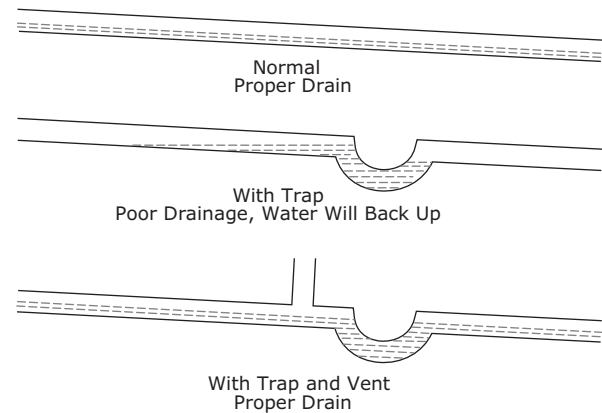

### A gravity drain may be used if:

Drain line has at least a 1" drop per 48" (approximately 2 cm drop per 100 cm) of run.

Drain line does not create traps and is vented per local code.

1. Cut the pre-installed drain tube to length.
2. Connect to your local plumbing per the local code.
3. If necessary, insulate drain line to prevent condensation.



**Failure to connect water supply or drain line connections properly can result in personal injury and property damage. Gravity drain connections must be routed downward from the rest of the unit at the rate of 1/4" per foot (1 cm per 50 cm).**

## FACTORY INSTALLED DRAIN PUMP

If your drain line will run up to a stand pipe, disposal or spigot assembly, or does not otherwise meet the requirements for a gravity drain, you may have ordered a pre-installed U-Line P60 drain pump.

If you need to install a P60 drain pump into your unit, see DRAIN PUMP section in the User Manual.

See below for typical installations requiring a drain pump.

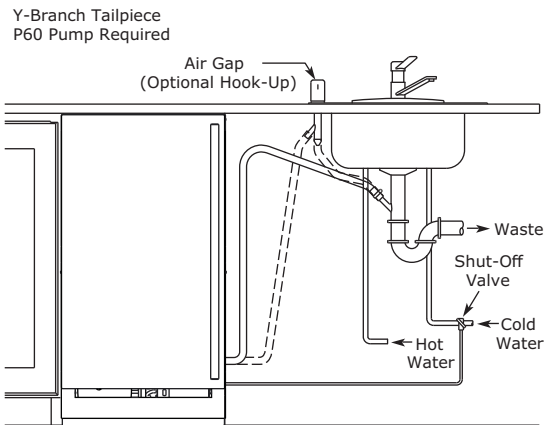

**The maximum lift for the P60 drain pump is 10 feet. This must be done as close to the rear of the unit as possible.**

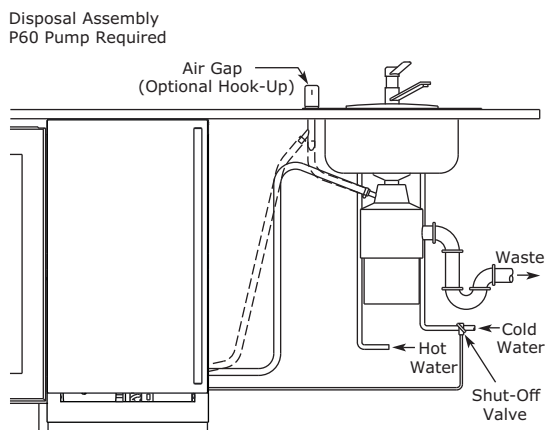
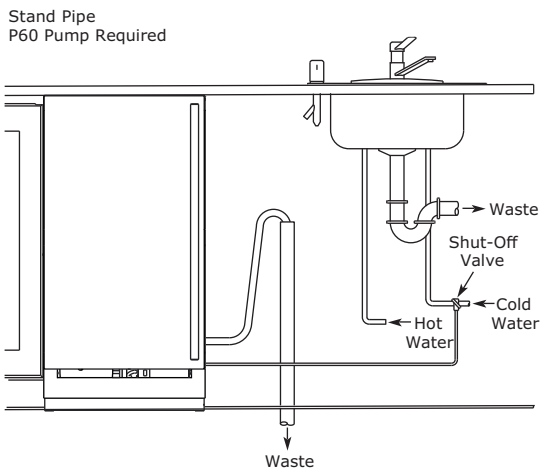

## Door Swing

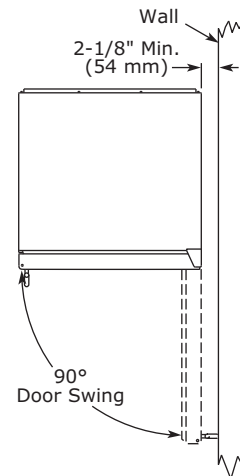

Units have a zero clearance for the door to open 90°, when installed adjacent to cabinets.

Stainless Steel models require 2-1/8" (54 mm) door clearance to accommodate the handle if installed next to a wall.

## Door Adjustments

### CRESCENT ICE MAKERS

#### HINGE COVER

Hinge cover included with the literature bag is optional.

#### To install hinge cover:

Press hinge cover squarely over hinge

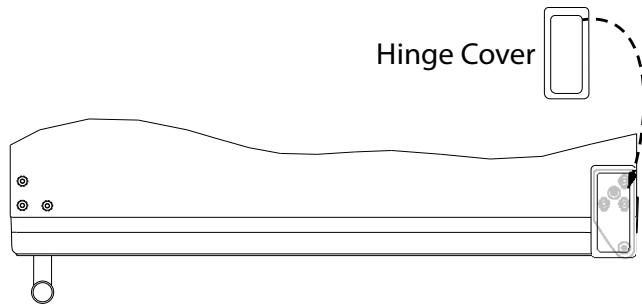

#### DOOR ALIGNMENT AND ADJUSTMENT

Align and adjust the door if it is not level or is not sealing properly. If the door is not sealed, the unit may not cool properly, or excessive frost may form in the interior.

**Properly aligned, the door's gasket should be firmly in contact with the cabinet all the way around the door (no gaps). Carefully examine the door's gasket to ensure that it is firmly in contact with the cabinet. Also make sure the door gasket is not pinched on the hinge side of the door.**

#### To align and adjust the door:

1. Gently pry off hinge cover from top of unit.
2. Loosen (do not remove) top and bottom hinge screws using a Torx T-25 screwdriver on the top and a 1/4" socket on the bottom.
3. Align door squarely with cabinet.
4. Make sure gasket is firmly in contact with cabinet all the way around the door (no gaps).

5. Tighten bottom hinge screws.

6. Tighten top hinge screws and replace hinge cover.

#### REVERSING THE DOOR

Location of the unit may make it desirable to mount the door on the opposite side of the cabinet.

The hinge hardware will be removed and reinstalled on the opposite side of the cabinet.

#### TO REVERSE THE DOOR

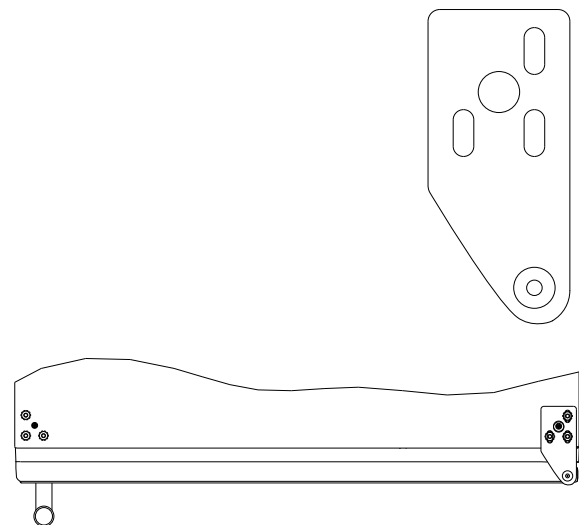

#### Remove top hinge and door:

1. Remove hinge cover from top of unit.
2. Hold door to keep it from falling.
3. Remove top hinge from cabinet using a Torx T-25 screwdriver to remove three screws. Set aside.

- Remove door by tilting forward and lifting door off bottom hinge. Retain shoulder washers; they will be reused.
- Remove three screws from hinge holes on the opposite side. Reinstall into holes where the hinge was removed. Take care not to scratch cabinet.

### Remove bottom hinge:

- Remove bottom hinge from cabinet using 1/4" socket.

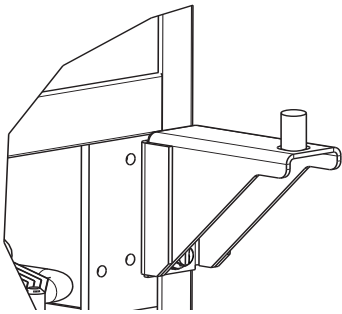

- Remove corresponding screws on opposite side of cabinet. On some models there may be a nut behind one or both screws on either side.

### Install bottom hinge:

Install two or three screws, depending on model. Replace nuts if used.

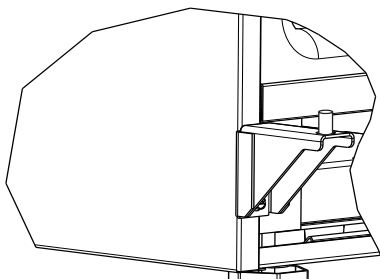

### Prepare door for reinstallation:

- Remove gasket.
- Rotate gasket 180° and press firmly into the gasket channel starting at the corners..

### Install top hinge and door:

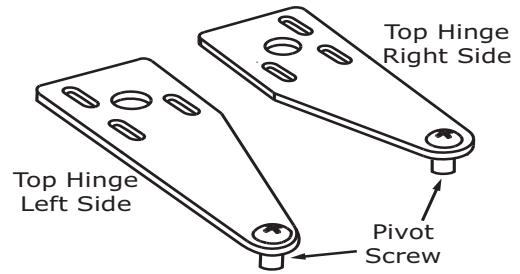

- Remove pivot screw from hinge, flip hinge over, and install the pivot screw in the same hole from the opposite surface.

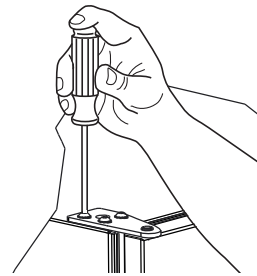

- On the opposite side, align edge of the hinge with the outer edge of the unit; leave screws loose to allow door to fit under hinge.
- Lift the door onto the bottom hinge.
- Tighten three hinge screws and replace hinge cover.

### Align and adjust the door:

Align and adjust the door (see DOOR ALIGNMENT AND ADJUSTMENT).

## Door Adjustments

### 15" REFRIGERATORS AND CLEAR ICE MACHINES

#### HINGE COVER

Hinge cover included with the literature bag is optional.

#### To install hinge cover:

Press hinge cover squarely over hinge

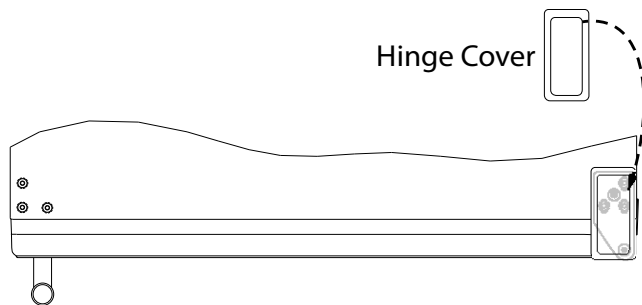

#### DOOR ALIGNMENT AND ADJUSTMENT

Align and adjust the door if it is not level or is not sealing properly. If the door is not sealed, the unit may not cool properly, or excessive frost may form in the interior.

**Properly aligned, the door's gasket should be firmly in contact with the cabinet all the way around the door (no gaps). Carefully examine the door's gasket to ensure that it is firmly in contact with the cabinet. Also make sure the door gasket is not pinched on the hinge side of the door.**

#### To align and adjust the door:

1. Gently pry off hinge cover from top of unit.
2. Loosen (do not remove) top and bottom hinge screws using a Torx T-25 screwdriver on the top and a 1/4" socket on the bottom.
3. Align door squarely with cabinet.
4. Make sure gasket is firmly in contact with cabinet all the way around the door (no gaps).

5. Tighten bottom hinge screws.

6. Tighten top hinge screws and replace hinge cover.

#### REVERSING THE DOOR

Location of the unit may make it desirable to mount the door on the opposite side of the cabinet.

The hinge hardware will be removed and reinstalled on the opposite side of the cabinet.

#### TO REVERSE THE DOOR

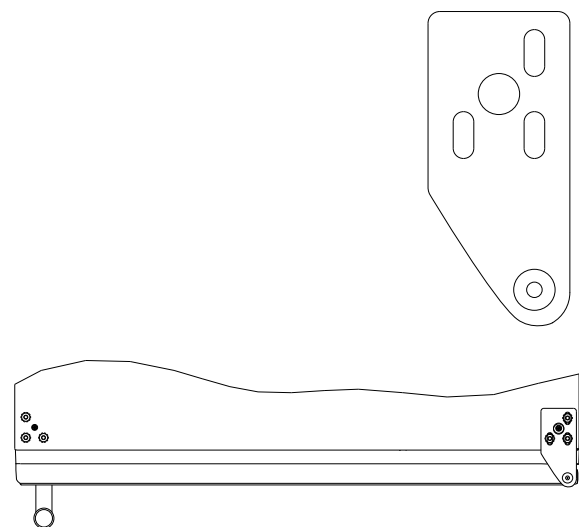

#### Remove top hinge and door:

1. Remove hinge cover from top of unit.
2. Hold door to keep it from falling.
3. Remove top hinge from cabinet using a Torx T-25 screwdriver to remove three screws. Set aside.
4. Remove door by tilting forward and lifting door off bottom hinge. Retain shoulder washers; they will be reused.
5. Remove three screws from hinge holes on the opposite side. Reinstall into holes where the hinge was removed. Take care not to scratch cabinet.

## Remove bottom hinge:

1. Remove bottom hinge from cabinet using 1/4" socket.

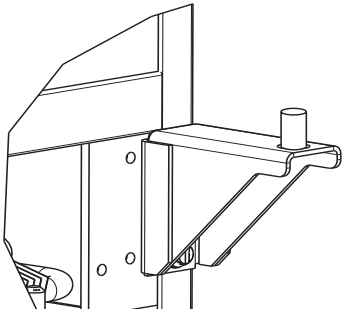

2. Remove corresponding screws on opposite side of cabinet. On some models there may be a nut behind one or both screws on either side.

## Install bottom hinge:

Install two or three screws, depending on model. Replace nuts if used.

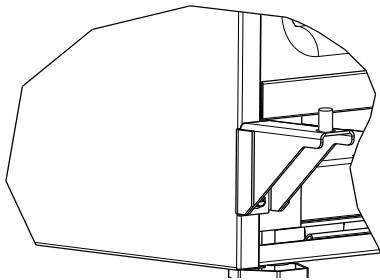

## Prepare door for reinstallation:

1. Remove gasket. This will reveal mounting holes for the magnet assembly.
2. Remove magnet assembly from door with T-10 TORX driver. Be sure to only remove the two screws holding the assembly to the door. Reinstall on the opposite end of the door.
3. Rotate gasket 180°, aligning notch with magnet assembly and pressing firmly into the gasket channel starting at the corners.

## Install top hinge and door:

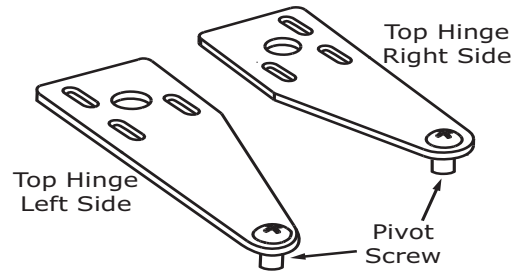

1. Remove pivot screw from hinge, flip hinge over, and install the pivot screw in the same hole from the opposite surface.

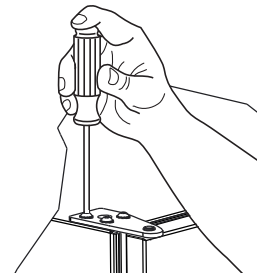

2. On the opposite side, align edge of the hinge with the outer edge of the unit; leave screws loose to allow door to fit under hinge.
3. Lift the door onto the bottom hinge.
4. Tighten three hinge screws and replace hinge cover.

## Align and adjust the door:

Align and adjust the door (see DOOR ALIGNMENT AND ADJUSTMENT).

## Door Adjustments

### 24" MODELS AND NUGGET ICE MACHINES

#### HINGE COVER

Hinge cover included with the literature bag is optional.

#### To install hinge cover:

1. Press hinge cover squarely over hinge.

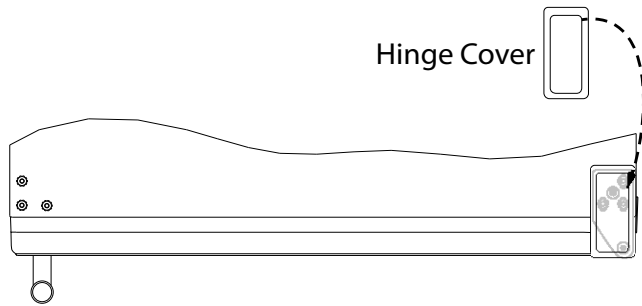

#### DOOR ALIGNMENT AND ADJUSTMENT

Align and adjust the door if it is not level or is not sealing properly. If the door is not sealed, the unit may not cool properly, or excessive frost may form in the interior.

**Properly aligned, the door's gasket should be firmly in contact with the cabinet all the way around the door (no gaps). Carefully examine the door's gasket to ensure that it is firmly in contact with the cabinet. Also make sure the door gasket is not pinched on the hinge side of the door.**

#### To align and adjust the door:

1. Gently pry off hinge cover from top of unit.
2. Loosen (do not remove) top and bottom hinge screws using a Torx T-25 screwdriver.
3. Align door squarely with cabinet.
4. Make sure gasket is firmly in contact with cabinet all the way around the door (no gaps).
5. Tighten bottom hinge screws.

6. Tighten top hinge screws and replace hinge cover.

#### REVERSING THE DOOR

Location of the unit may make it desirable to mount the door on the opposite side of the cabinet.

The hinge hardware will be removed and reinstalled on the opposite side of the cabinet.

#### TO REVERSE THE DOOR

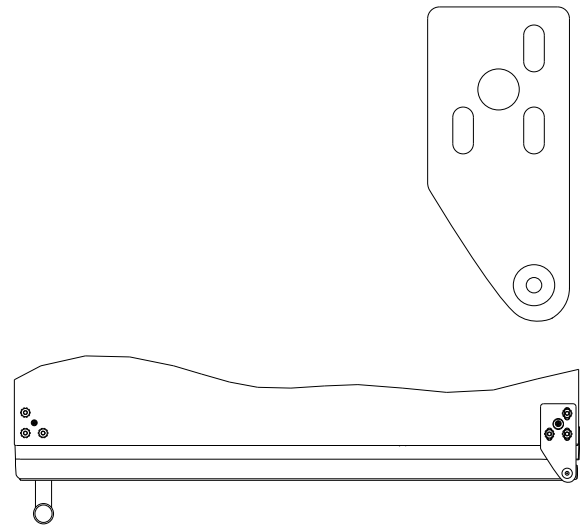

#### Remove grille:

Remove the grille

#### Remove top hinge and door:

1. Hold door to keep it from falling.
2. Remove top hinge from cabinet using a Torx T-25 screwdriver to remove three screws. Set aside and save for possible future use.

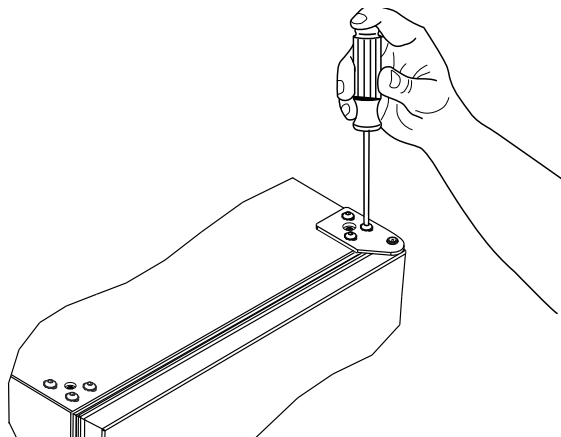

3. Remove door by tilting forward and lifting door off bottom hinge. Retain shoulder washers; they will be reused.
4. Remove three screws from hinge holes on the opposite side. Reinstall into holes where the hinge was removed. (If utilizing supplied screw cover, install just one screw.)

### Remove bottom hinge:

1. Remove bottom hinge from cabinet using a T-10 TORX screw driver to remove three screws.

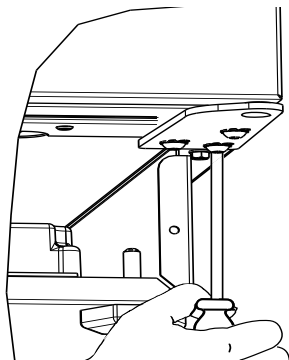

2. Remove corresponding screws on opposite side of cabinet. On some models there may be a nut behind one or both screws on either side.

### Install bottom hinge:

Install two or three screws, depending on model. Replace nuts if used.

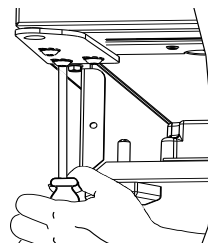

### Prepare door for reinstallation:

1. Remove gasket. This will reveal mounting holes for the magnet assembly.
2. Remove magnet assembly from door with T-10 TORX driver. Be sure to only remove the two screws holding the assembly to the door. Reinstall on the opposite end of the door.
3. Rotate gasket 180°, aligning notch with magnet assembly and pressing firmly into the gasket channel starting at the corners.
4. Rotate door 180° to reverse.

### Install top hinge and door:

1. Install hinge with longer straight edge aligned to outside edge of cabinet. Do not tighten.

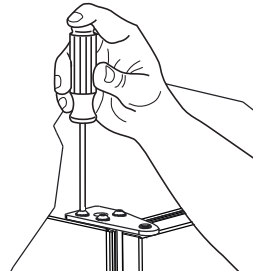

2. Lift the door on to the bottom hinge.
3. Align edge of the hinge with the outer edge of the unit.
4. Tighten three hinge screws.

### Align and adjust the door:

Align and adjust the door (see DOOR ALIGNMENT AND ADJUSTMENT).

### Install grille and top covers



## General Installation

### LEVELING INFORMATION

1. Use a level to confirm the unit is level. Level should be placed along top edge and side edge as shown.

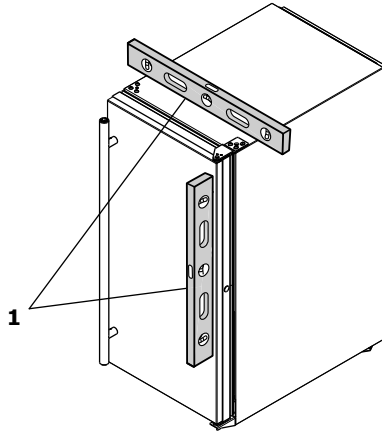

2. If the unit is not level, adjust the legs on the corners of the unit as necessary.

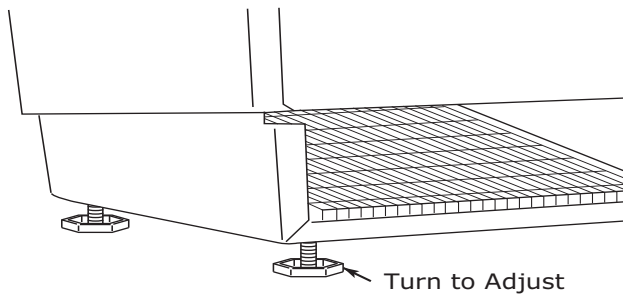

3. Confirm the unit is level after each adjustment and repeat the previous steps until the unit is level.

### INSTALLATION TIP

If the room floor is higher than the floor in the cutout opening, adjust the rear legs to achieve a total unit rear height of 1/8" (3 mm) less than the opening's rear height. Shorten the unit height in the front by adjusting the front legs. This allows the unit to be gently tipped into the opening. Readjust the front legs to level the unit after it is correctly positioned in the opening.

### INSTALLATION

1. Plug in the power/electrical cord.
2. Gently push the unit into position. Be careful not to entangle the cord or water and drain lines, if applicable.
3. Re-check the leveling, from front to back and side to side. Make any necessary adjustments. The unit's top surface should be approximately 1/8" (3 mm) below the countertop.
4. Install the anti-tip bracket.
5. Remove interior packing material and wipe out the inside of the unit with a clean, water-dampened cloth.

## Control Operation

### REFRIGERATORS

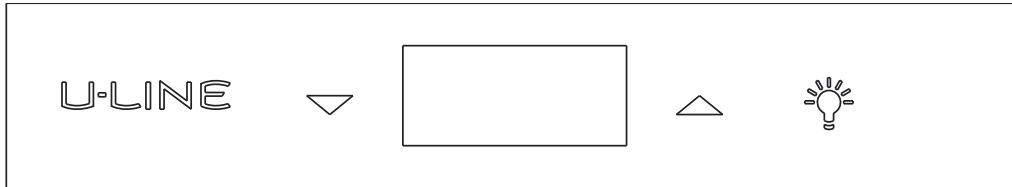

### CONTROL FUNCTION GUIDE

FUNCTION	COMMAND	NOTES
ON/OFF	Press ▾ and hold for 5 seconds	Unit will turn ON or OFF
Leave interior light on	Press 💡 and release to leave interior light on for 3 hours; press again to deactivate	After 3 hours, factory default is restored; light will turn on when door is open
Adjust temperature	Press ▲ or ▾ and release	When the display is flashing, press ▲ or ▾ to adjust the set point temperature. Note: temperature displayed is the actual temperature inside unit
Toggle between °F / °C	Hold ▲ and ▾ for 5 seconds	The display will change units
Enable Sabbath Mode	Press 💡 and hold for 5 seconds and release.	The °F / °C symbol will flash briefly after 5 seconds. Interior light and display will go dark and remain so until user resets mode - unit continues to operate
Disable Sabbath Mode	Press 💡 and release	Display and interior light return to normal operation

This unit is Star-K certified. See [www.star-k.org](http://www.star-k.org) for more details

### DOOR ALERT NOTIFICATION

When the door is left open for more than 5 minutes:

- A tone will sound for several seconds every minute
- **dr** will appear in display



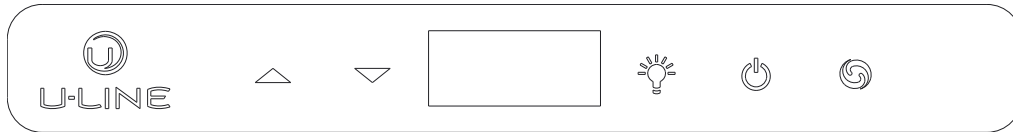

Close door to silence alert and reset

## Control Operation

### CLEAR ICE MACHINES



### CONTROL FUNCTION GUIDE

FUNCTION	COMMAND	NOTES
ON/OFF	Press  and release	Unit will immediately turn ON or OFF
Adjust ice thickness	See "Ice" section	
Enable Sabbath Mode	Press  and hold for 5 seconds and release	The °F / °C symbol will flash briefly after 5 seconds. Interior light and display will go dark and remain so until user resets mode - unit continues to operate
Disable Sabbath Mode	Press  and release	Display and interior light return to normal operation
Silent Mode (ice production suspended for 3 hours)	Hold  and 	Display will countdown the hours: 3H, 2H, 1H
Clean Mode	See "Cleaning" section	







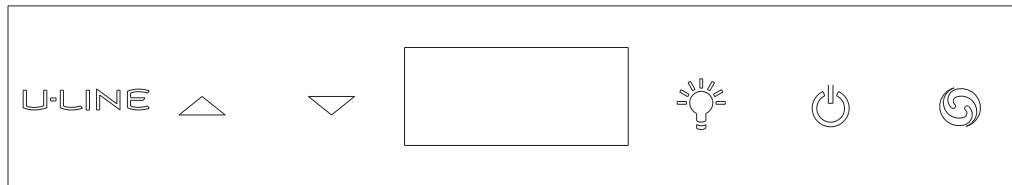



This unit is Star-K certified. See [www.star-k.org](http://www.star-k.org) for more details.

## Control Operation

### CONVERTIBLE FREEZER



### CONTROL FUNCTION GUIDE

FUNCTION	COMMAND	NOTES
ON/OFF	Press  and release	Unit will immediately turn ON or OFF
Leave interior light on	Press  and release to leave interior light on for 12 hours; press again to deactivate	After 12 hours, factory default is restored; light will turn on when door is open
Adjust Temperature	Press  or  and release	When the display is flashing, press  or  to adjust the set point temperature. Note: temperature displayed is the actual temperature inside unit
Toggle between °F / °C	Hold  and  for 5 seconds	The display will change units
Toggle between Freezer/ Refrigerator	Hold  for 5 seconds	Unit will “beep” and display will show the default set point for Refrigerator/Freezer
Enable Sabbath Mode	Press  and hold for 5 seconds and release	The °F / °C symbol will flash briefly after 5 seconds. Interior light and display will go dark and remain so until user resets mode - unit continues to operate
Disable Sabbath Mode	Press  and release	Display and interior light return to normal operation

This unit is Star-K certified. See [www.star-k.org](http://www.star-k.org) for more details.

### DOOR ALERT NOTIFICATION

When the door is left open for more than 5 minutes:

- A tone will sound for several seconds every minute
-  will appear in display



Close door to silence alert and reset.

## Control Operation

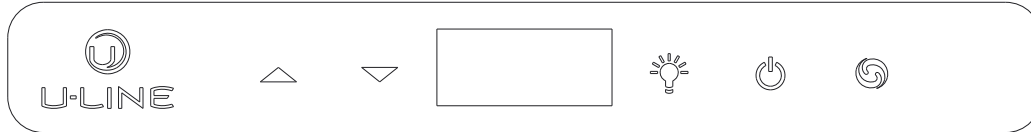
### NUGGET ICE MACHINES



#### CONTROL FUNCTION GUIDE

FUNCTION	COMMAND	NOTES
ON/OFF	Press  and release	Unit will immediately turn ON or OFF.
Enable Sabbath Mode	Press  and hold for 5 seconds and release.	The °F / °C symbol will flash briefly after 5 seconds. Interior light and display will go dark and remain so until user resets mode - unit continues to operate.
Disable Sabbath Mode	Press  and release.	Display and interior light return to normal operation.
Clean Mode	See "Cleaning" section	

This unit is Star-K certified. See [www.star-k.org](http://www.star-k.org) for more details.

#### DOOR ALERT NOTIFICATION

When the door is left open for more than 30 minutes:

- Ice production will cease
- A tone will sound for several seconds every minute
-  will appear in display

Close door to silence alert and reset (Ice production will resume if bin sensor is not satisfied)

## First Use

### CRESCENT ICE MAKERS

Initial startup requires no adjustments.

**U-Line recommends discarding the ice produced during the first two to three hours of operation to avoid possible dirt or scale that may dislodge from the water line.**

**To turn the unit on or off:**



Press the rocker switch located inside the door on the front panel, or behind the grille.



### REFRIGERATORS

Initial startup requires no adjustments. If the unit was turned off, press and hold  for 5 seconds to turn unit on. See "Control Operation" section for more details.

**Temperature displayed reflects actual temperature inside unit.**

If the temperature displayed is different than selected, the unit is progressing towards the selected temperature. Time to reach set point varies based upon ambient temperature, temperature of product loaded, door openings, etc. U-Line recommends allowing the unit to reach set point before loading.

### CONVERTIBLE FREEZER

Initial startup requires no adjustments. If the unit was turned off, press  and the unit will immediately switch on. To turn off, press  and release. See CONTROL OPERATION section for more details.

**Temperature displayed reflects actual temperature inside unit.**

If the temperature displayed is different than selected, the unit is progressing towards the selected temperature. Time to reach set point varies based upon ambient temperature, temperature of product loaded, door openings, etc. U-Line recommends allowing the unit to reach set point before loading.



Approximate time required (empty unit) when converting between refrigerator and freezer:

- **38°F to 0°F - 1 hour**
- **0°F to 38°F - 4 hours**

### CLEAR ICE AND NUGGET ICE MACHINES

Initial startup requires no adjustments. See CONTROL OPERATION section for more details.

**U-Line recommends discarding the ice produced during the first two to three hours of operation to avoid possible dirt or scale that may dislodge from the water line.**

When plugged in, the unit will begin operating under the factory default settings. If the unit was turned off during installation, simply press  and the unit will immediately switch on. To turn the unit off, press  and release.

## Ice

### CRESCENT ICE MAKERS

#### ICE MAKER OPERATION

When the ice bucket is full, the ice making mechanism will shut off. However, the refrigeration system will continue to cool and maintain the ice supply.

**Do not place cans or bottles in the ice compartment because they will freeze.**

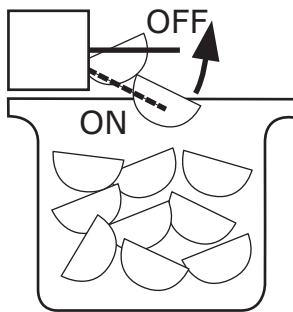

**To turn off ice production:** Raise the bin arm into an upright and locked position. The unit will preserve temperature for ice storage.

**If not intending to use the ice maker, turn the water supply valve off. It is also important to raise the bin arm of the ice maker (see above). Failure to raise the bin arm may result in damage to the water valve.**

Certain sounds are normal during the unit's operation. You may hear the compressor or fan motor, the water valve, or ice dropping into the ice bucket.



**NEVER use an ice pick, knife or other sharp instrument to separate cubes. Shake the ice bucket instead.**

During periods of limited use or high ambient temperatures, it is common for cubes to fuse together. Gently shake the bucket to break apart cubes. If not using the ice maker regularly, empty the ice bucket periodically to ensure fresh cubes.

It is normal for cubes to appear cloudy. The cause is air trapped in the water because of fast freezing. It is not caused by the health, taste or chemical make up of the water. It is the same air that is in every glass of water you drink.

Remove the ice bucket for emptying and cleaning. To remove the ice bucket, raise the bin arm and remove the bucket from the ice compartment. Use the ice bucket for ice storage only.

#### ICE MAKER ADJUSTMENT

##### Ice Cube Thickness Adjustment

##### Interval - As Required

On ice maker equipped models, adjust the cube size by changing water amount injected into the ice maker assembly as follows:

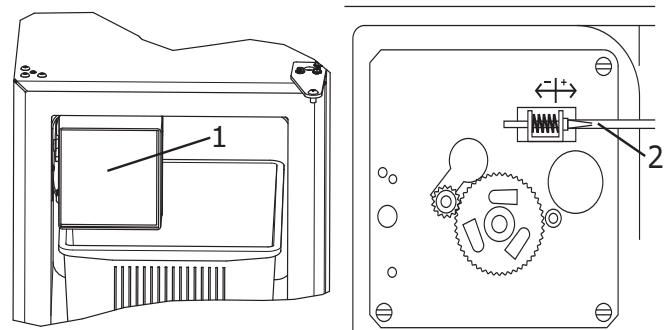

1. Remove the ice maker assembly cover (1).
2. Find the adjusting screw on the ice maker assembly control box (2). The adjusting screw is just below the minus (-) and plus (+) signs on the control box.

## ⚠ CAUTION

**Too large of an adjustment to the screw can cause the water to overflow the ice maker and can cause property damage.**

- Turn the adjusting screw toward the minus (-) sign (clockwise) for smaller cubes or toward the plus (+) sign (counterclockwise) for larger cubes.
- Install the ice maker assembly cover.

### ADJUSTING ICE HARVEST

- Remove the front grille
- Using a flat tip screwdriver, turn the adjusting screw (3) a small increment clockwise for a COLDER setting (slower ice production) or counterclockwise for a WARMER setting (faster ice production).

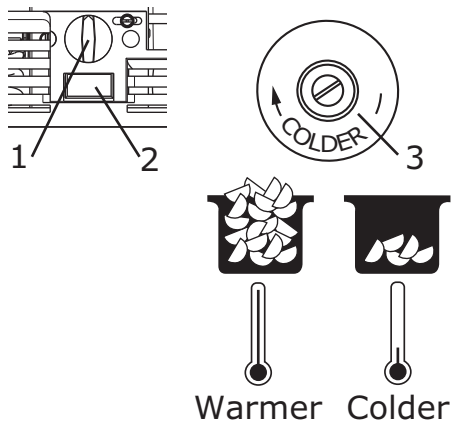

- Reinstall the front grille (two screws).

### CLEAR ICE MACHINES

#### ICE CUBE THICKNESS ADJUSTMENT

**Ice thickness adjustment should only be made one increment at a time. Allow ice maker production to stabilize for 24 hours before rechecking ice thickness.**

Ice is produced in layers resulting in a clear cube. Ice in bin may develop surface frost which disappears when cube is placed in liquid.

Ice cubes in any given batch will vary, so it is necessary to choose cubes from the sample area for comparison when making adjustments.

The ice cube thickness is factory set for best overall performance. The factory setting is designed to maintain an ice bridge of approximately 1/16" to 1/8" (1.6 mm to 3.2 mm) under normal conditions, resulting in a dimple of approximately 1/4" to 1/2" (6.4 mm to 12.7 mm) in depth. A fuller cube with less of a dimple results in a thicker ice bridge. As the ice bridge becomes thicker, the tendency for the cubes to stay together as a slab increases. A bridge thicker than 1/8" (3.2 mm) may cause cubes to overfill the ice bucket.

32 ice cubes are formed on a 4 x 8 slab during each cycle. Each cycle takes approximately 15-20 minutes at the default cube thickness (0).

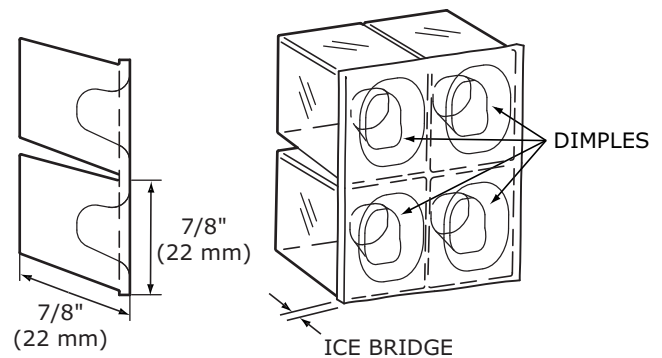



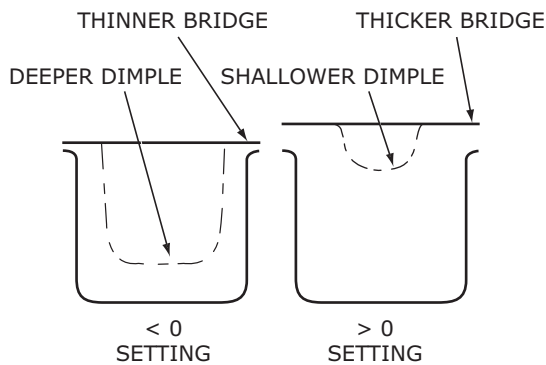
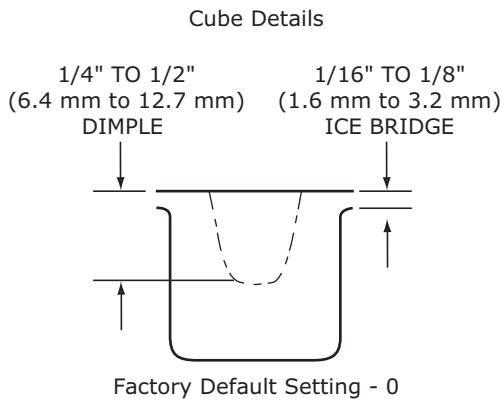

Your clear ice machine is preset to produce ice between the optimal dimensions illustrated below:



Ice thickness adjustments are made using the control panel as follows:

1. To enter the thickness adjustment mode:

- Press and hold  for 5 seconds.
- The display will switch to "0" to confirm the thickness adjustment mode has been selected.

The factory setting is "0". Use  to raise the setting and thicken the ice bridge, or  to lower the setting to thin the ice bridge.

Ice cubes in any given batch will vary, so it is necessary to choose cubes from the sample area for comparison when making adjustments.

## NUGGET ICE MACHINES

The Nugget Ice Machine produces cylindrical bits of compressed ice approximately  $3/4" \times 1/2"$ .

Ice is produced until the machine senses the bin is full. As ice slowly melts in the bin, the level of ice drops and ice production resumes. This ensures a constant supply of fresh ice is always available.

## Cleaning

### CLEAR ICE MACHINE CLEANING CYCLE

Your U-Line clear ice machine has an automatic clean alert function. Cleaning cycles should be run as notified. Otherwise, to maintain operational efficiency the unit should be cleaned every three months. Depending on water conditions, more frequent cleaning may be necessary. If the ice machine requires more frequent cleaning, consult a plumber to test the water quality and recommend appropriate treatment.



**Wear rubber gloves and safety goggles and/or face shield when handling Ice Machine Cleaner.**

### NOTICE

**Use only U-Line Ice Machine Cleaner (Part No. 80-54081-00), available from your dealer or direct from your local parts distributor. To locate a parts distributor near you, visit [u-line.com](http://u-line.com). It is a violation of federal law to use this solution in a manner inconsistent with its labeling. Use of any other cleaner can ruin the finish of the evaporator and will void the warranty. Read and understand all labels printed on the package before use.**

U-Line Ice Machine Cleaner is used to remove lime scale and other mineral deposits. Refer to the following steps to initiate the self-cleaning cycle.



**Never use anything to force ice from the evaporator. Damage may result.**

1. Turn the ice machine off and allow any ice to melt off of the evaporator.

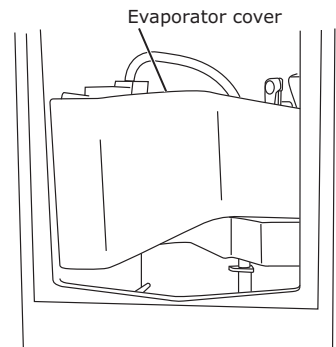

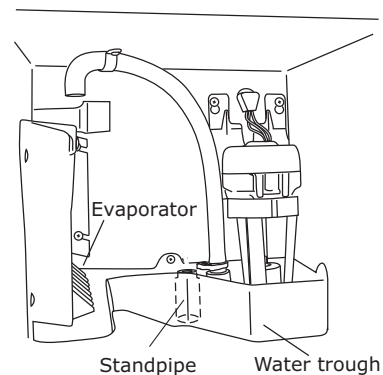

2. Remove all ice from the storage bin.
3. Remove evaporator cover.
4. Remove the standpipe by lifting it up while using a slight back and forth motion to loosen it from the drain hole. The water in the reservoir will flow down the drain.
5. Re-install the standpipe into the water trough.

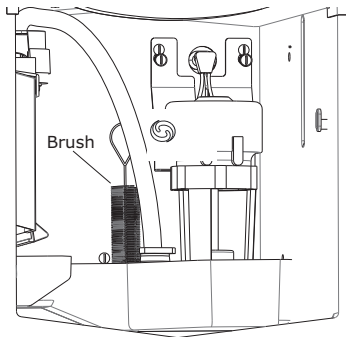

6. Clean the Interior Bin as follows:
  - Dilute one packet of U-Line Ice Machine Cleaner into two quarts of water.

- Using a sponge or cloth, clean interior of ice bin, tubing and door. This cleaner will remove all mineral deposits and other contaminants from the surfaces.
- Using a bottle brush, clean out the trough drain tube and pump tubing where needed.



7. Turn unit on by pressing 
8. Place the unit into CLEAN mode by holding  for 5 seconds.
9. When water begins flowing over the evaporator (approximately 3 minutes), pour 1 packet of CLR cleaner into the water trough. The cleaning process will last approximately 45 minutes.
10. Dilute 1 tablespoon bleach in 1 gallon of warm water. Apply this solution to the entire inside of the storage area. Then rinse thoroughly with water.

The unit will resume operation approximately 15 minutes after the automated cleaning process is completed. The water fill valve will energize, fill the water reservoir, and shut-off after three minutes. The compressor begins to operate and water flows over the evaporator assembly (ice mold). Initially, the water flow may not be uniform, causing uneven sized cubes or water to spill into the ice storage bin. This is a normal situation that will correct itself within the first 24 hours of operation.

## NOTICE



**Discard all ice produced in the first harvest.**



**Should power to the unit be interrupted during the self-clean cycle, it will be necessary to repeat the complete cleaning cycle after power is restored.**

## REFRESH KIT

Due to variations in water quality or inadequate maintenance your unit may become excessively coated in lime scale or calcium. U-Line offers a cost effective refresh kit which replaces many interior components and will return your unit to like new condition. Refresh kits may be ordered from your local distributor and installed by your local service company. For information on your local distributor or service company please visit [www.u-line.com](http://www.u-line.com).

## NUGGET ICE MACHINE CLEANING CYCLE

This ice machine has an automatic clean alert function. The control will indicate  in the display, approximately every six months with normal use, reminding you to clean your unit. When  is displayed, ice production will continue. Depending on water conditions, more frequent cleaning may be necessary. Cleaning removes lime scale, other mineral deposits, and sanitizes the machine. Poor ice quality and reduced ice output are signs that cleaning is necessary. If the machine consistently requires more frequent cleaning, consult a plumber to test the water quality and recommend appropriate treatment.

**Under normal conditions cleaning should be done when the display shows . You may initiate a cleaning cycle at any time by pressing and holding the clean button for 10 seconds.  will appear in the display indicating the start of the cleaning process.**

You may override **CL** in the display without cleaning by pressing and holding the up, down, & light button for 10 seconds. **ICE** will scroll in the display and the cleaning reminder (**CL**) will be reset for another approximate six month cycle. Failure to clean may reduce the quality and quantity of ice produced. Once the clean cycle begins, it can be canceled by pressing **⏻** three times. Press **⏻** once more to start making ice. The clean cycle will automatically cancel if user fails to activate control at steps 2, 3b, and 5b within 2 hours.

## Required for cleaning:

- Hose and funnel – provided with unit
- Bucket and cleaning sponge
- Clean water
- SafeCLEAN Plus™ Cleaner (Part No. 80-55266-00)  
– included with unit

**Need more cleaner? Visit [u-line.com](http://u-line.com).**



**Use only SafeCLEAN Plus™ Cleaner. Use of any other cleaner may damage the finish of the evaporator and will void the warranty.**

**Follow safety and handling instructions printed on the SafeCLEAN Plus™ bottle.**

## NOTICE:

**For 3 Class models only: the water filter must remain in place during the cleaning process.**

**Cleaning Process** (approximate time: 40 minutes)





1. Press and Hold **⏻** for 5 - 10 seconds

- a. **01** will appear in the display
- b. Remove access shield

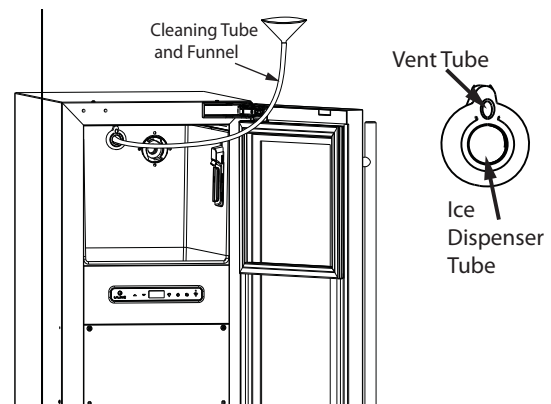
- c. Remove all ice in bin
- d. Remove any ice protruding from the ice dispenser tube
- e. Insert the end of the cleaning tube into the ice dispenser; slowly pour in approximately 1 quart of hot water. This will melt ice inside the dispenser tube. It is normal for some water to flow out of the ice dispenser tube and exit from the vent tube while pouring. Omit this step if no ice is in the ice dispenser tube.



2. Press and release **⏻**
  - a. **02** will appear in the display
  - b. Mix 4 ounces of SafeCLEAN Plus™ with 2 quarts of water
3. Wait until **03** appears in the display
  - a. Using the funnel and cleaning tube, slowly pour  $\frac{3}{4}$  of the cleaning solution into the dispenser tube. Air and some water will exit the vent tube. Remove cleaning tube.
  - b. Press and release **⏻**
4. **04** will appear in the display
  - a. The machine will circulate the solution, cleaning and sanitizing the internal components, for approximately 20 minutes
  - b. While the machine is circulating the cleaning solution, use the remaining cleaning solution and a sponge to wipe down the inside of the ice bin and scoop. Rinse thoroughly with clean water
5. When **05** appears in the display, 3 soft tones will sound, indicating the cleaning phase is complete
  - a. Using the hose and funnel, slowly pour 1.5 quarts (48 oz.) of clean water into the ice dispenser tube. Air and some water will exit the vent tube

- b. Press and release 
- 6.  will appear in the display
  - a. Reinstall shield and close door - no further action is required
  - b. The machine will circulate water and perform a series of final rinses for approximately 15 minutes.

The unit will resume making ice - indicated by 3 soft tones and  scrolling in the display.

# U-Line Corporation (U-Line) Limited Warranty

## One Year Limited Warranty

For one year from the date of original purchase, this U-Line product warranty covers all parts and labor to repair or replace any part of the product that proves to be defective in materials or workmanship. For products installed and used for normal residential use, material cosmetic defects are included in this warranty, with coverage limited to 60 days from the date of original purchase. All service provided by U-Line under the above warranty must be performed by U-Line factory authorized service, unless otherwise specified by U-Line. Service provided during normal business hours.

## Available Second Year Limited Warranty

Beyond the standard one year warranty outlined above, U-Line offers an extension of the one year warranty coverage for an additional second year from the date of purchase, free of charge. To take advantage of this second year warranty, you must register your product with U-Line within two months from the date of purchase at [u-line.com](http://u-line.com) providing proof of purchase.

## Five Year Sealed System Limited Warranty

For five years from the date of original purchase, U-Line will repair or replace the following parts, labor not included, that prove to be defective in materials or workmanship: compressor, condenser, evaporator, drier, and all connecting tubing. All service provided by U-Line under the above warranty must be performed by U-Line factory authorized service, unless otherwise specified by U-Line. Service provided during normal business hours.

## Terms

These warranties apply only to products installed in any one of the fifty states of the United States, the District of Columbia, or the ten provinces of Canada. The warranties do not cover any parts or labor to correct any defect caused by negligence, accident or improper use, maintenance, installation, service, repair, acts of God, fire, flood or other natural disasters. The product must be installed, operated, and maintained in accordance with the U-Line User Guide.

The remedies described above for each warranty are the only ones that U-Line will provide, either under these warranties or under any warranty arising by operation of law. U-Line will not be responsible for any consequential or incidental damages arising from the breach of these warranties or any other warranty, whether express, implied, or statutory. Some states do not allow the exclusion or limitation of incidental or consequential damages, so the above limitation or exclusion may not apply to you. These warranties give you specific legal rights, and you may also have other rights which vary from state to state.

Any warranty that may be implied in connection with your purchase or use of the product, including any warranty of merchantability or any warranty fit for a particular purpose is limited to the duration of these warranties, and only extends to five years in duration for the parts described in the section related to the five year limited warranty above. Some states do not allow limitations on how long an implied warranty lasts, so the above limitations may not apply to you.

- The warranties only apply to the original purchaser and are non-transferable.
- The second year and five year warranties cover products installed and used for normal residential or designated marine use only.
- The warranties apply to units operated outside only if designed for outdoor use by model and serial number.
- Replacement water filters, light bulbs, and other consumable parts are not covered by these warranties.
- The start of U-Line's obligation is limited to four years after the shipment date from U-Line.
- In-home instruction on how to use your product is not covered by these warranties.
- Food, beverage, and medicine loss are not covered by these warranties.
- If the product is located in an area where U-Line factory authorized service is not available, you may be responsible for a trip charge or you may be required to bring the product to a U-Line factory authorized service location at your own expense.
- Units purchased after use as floor displays, and/or certified reconditioned units, are covered by the limited one year warranty only and no coverage is provided for cosmetic defects
- Signal issues related to Wi-Fi connectivity are not covered by these warranties.

For parts and service assistance, or to find U-Line factory authorized service near you, contact U-Line:  
8900 N. 55th Street, Milwaukee, WI 53223 • [u-line.com](http://u-line.com) • [onlineservice@u-line.com](mailto:onlineservice@u-line.com) • +1.800.779.2547