

MARTINI 50

FREESTANDING FIRE TABLE



Elegant, simple, and ever so functional, the Martini 50 fire pit table is perfect for entertaining. With sufficient space to set down food or drinks, the fire becomes a welcoming destination for guests to gather around. With a sunken circular flame at its centre Martini certainly knows how to grab your attention.

Finish

Available in a variety of Fluid concrete colours or Natural Teak finish.

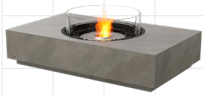

Natural

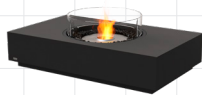

Graphite



Bone

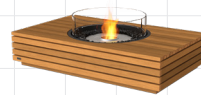

Natural (Oiled)

Concrete Surround Options

Teak Surround Option

Versatile and Re-locatable

When you select Bioethanol or Liquid Propane as your fuel source you'll never be tied down! With zero hard utility connections, relocating your fire is a breeze. Entertain on your own terms with EcoSmart Fire.

Global Compliance

LP/NG Burners are UL/ULC Listed. Bioethanol Burner is UL Listed, and ACCC Safety Mandate compliant.

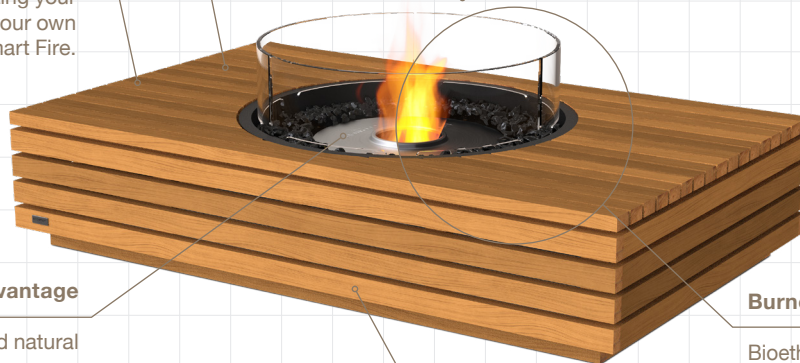

Triple Fuel Advantage

Choose between plumbed natural gas, readily available propane, or our eco-friendly bioethanol fuel system. We make it easy for you to achieve exactly what you want, for exactly where you want it.

Burner Colors

Bioethanol models are available with a Stainless Steel or Black Burner.

Incredibly Durable

EcoSmart portable fireplaces are versatile, incredibly durable, and are constructed of weather resistant materials. These appliances are designed to look great for years, and will perform admirably through all four seasons.

Included Accessories

Optional Accessory

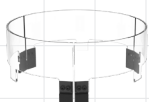

Fire Screen

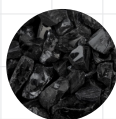

Black Glass Charcoal



Winter Storage Bag (Outdoor models only)



Jerry Can (Ethanol only)



Lighting Rod + Lighter (Ethanol only)



AB8 Burner Efficiency Ring (Ethanol only)





Tank (Cover, Stool/Side Table)



Disclaimer: All product specifications and data are subject to change without notice and believed to be correct at the time of publication. MAD Design Group (MDG), its affiliates, agents, and employees, and all persons acting on its or their behalf (collectively, "MAD Design Group"), disclaim any and all liability for any errors, inaccuracies or incompleteness contained herein or in any other disclosure relating to any product. MDG disclaims any and all liability arising out of the use or application of any product described herein or of any information provided herein to the maximum extent permitted by law. The product specifications do not expand or otherwise modify MDG's terms and conditions of purchase, including but not limited to the warranty expressed therein, which apply to these products. No license, express or implied, by estoppel or otherwise, to any intellectual property rights is granted by this document or by any conduct of MDG. Customers using or selling MDG products not expressly indicated for use in such applications do so entirely at their own risk and agree to fully indemnify MDG for any damages arising or resulting from such use or sale. Please contact authorized personnel from MDG to obtain written terms and conditions regarding products designed for such applications. Images are indicative only.

Martini 50



Application	Outdoor and Indoor ¹
Materials	Fluid Concrete or Teak, Grade 304 Stainless Steel Burner, Toughened Glass Fire Screen
Weight (approx)	Concrete 53.2kg [117.1lbs] Teak 47.2kg [103.9lbs] Weight includes burner and accessories.

LP/NG		
Concrete SKU's	 Natural	ESF.5.O.MT1.50.NA.G
	 Bone	ESF.5.O.MT1.50.BO.G
	 Graphite	ESF.5.O.MT1.50.GH.G
Teak SKU	 Natural (Oiled)	ESF.5.O.MT1.50.TN.G

BIOETHANOL		
Concrete SKU's	 Natural	ESF.5.O.MT1.50.NA.E
	 Bone	ESF.5.O.MT1.50.BO.E
	 Graphite	ESF.5.O.MT1.50.GH.E
Teak SKU	 Natural (Oiled)	ESF.5.O.MT1.50.TN.E

Burner Colors	Stainless Steel or Black
----------------------	--------------------------

FUEL OPTIONS*	BTU/HR	BURN HOURS*
Liquid Propane	65,000	8 - 20
Natural Gas	65,000	Unlimited
Bioethanol	20,000	7 - 11

*These values are indicative only.

¹ Only bioethanol models are suitable to use indoors. For Indoor Use, additional parts are required. Your chosen application is the ONLY application the model can be used in due to modified configuration of the model. Please advise your Sales Representative at time of purchase so that the product can be configured accordingly. This model comes with fixing brackets for permanently locating into a fixed position.

Global Compliance
LP/NG Burners are UL/ULC Listed. Bioethanol Burner is UL Listed, and ACCC Safety Mandate compliant.

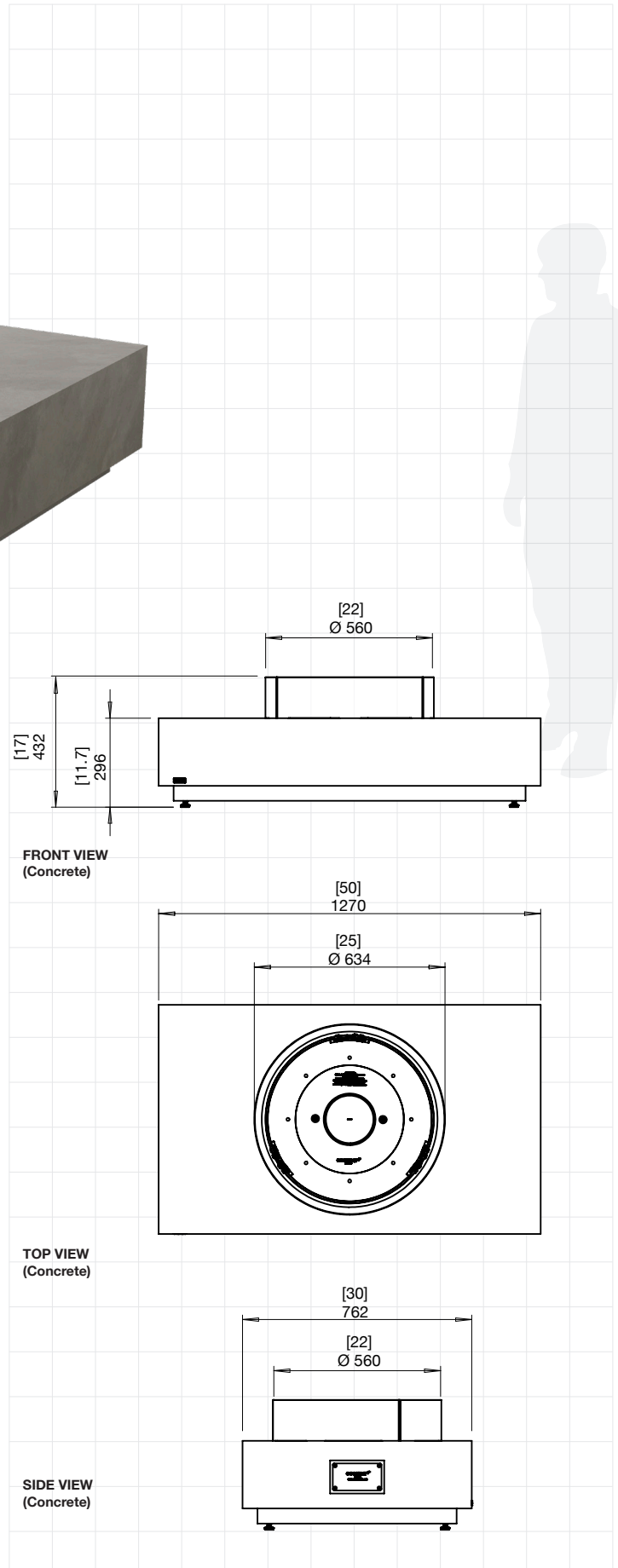

FOR MORE INFORMATION PLEASE REFERENCE THE CLEARANCE & INSTALLATION MANUAL

Disclaimer: All product specifications and data are subject to change without notice and believed to be correct at the time of publication. MAD Design Group (MDG), its affiliates, agents, and employees, and all persons acting on its or their behalf (collectively, "MAD Design Group"), disclaim any and all liability for any errors, inaccuracies or incompleteness contained herein or in any other disclosure relating to any product. MDG disclaims any and all liability arising out of the use or application of any product described herein or of any information provided herein to the maximum extent permitted by law. The product specifications do not expand or otherwise modify MDG's terms and conditions of purchase, including but not limited to the warranty expressed therein, which apply to these products. No license, express or implied, by estoppel or otherwise, to any intellectual property rights is granted by this document or by any conduct of MDG. Customers using or selling MDG products not expressly indicated for use in such applications do so entirely at their own risk and agree to fully indemnify MDG for any damages arising or resulting from such use or sale. Please contact authorized personnel from MDG to obtain written terms and conditions regarding products designed for such applications. Images are indicative only.