

# BROILMASTER® PREMIUM GRILLS

Model Numbers: BSACT26-1, BSACT34-1, BSACT42-1

### BEFORE GETTING STARTED

Unpack and lay out all of the included parts. Most of the stainless-steel pieces come with a protective film. Remove all of the film and take care with stainless steel components as to not scratch them during the assembly process.

 **CAUTION** 

Parts may have sharp edges. Wear leather work gloves and handle parts carefully during unpacking, assembly, and installation.

### Overview - Assemble On Level Surface

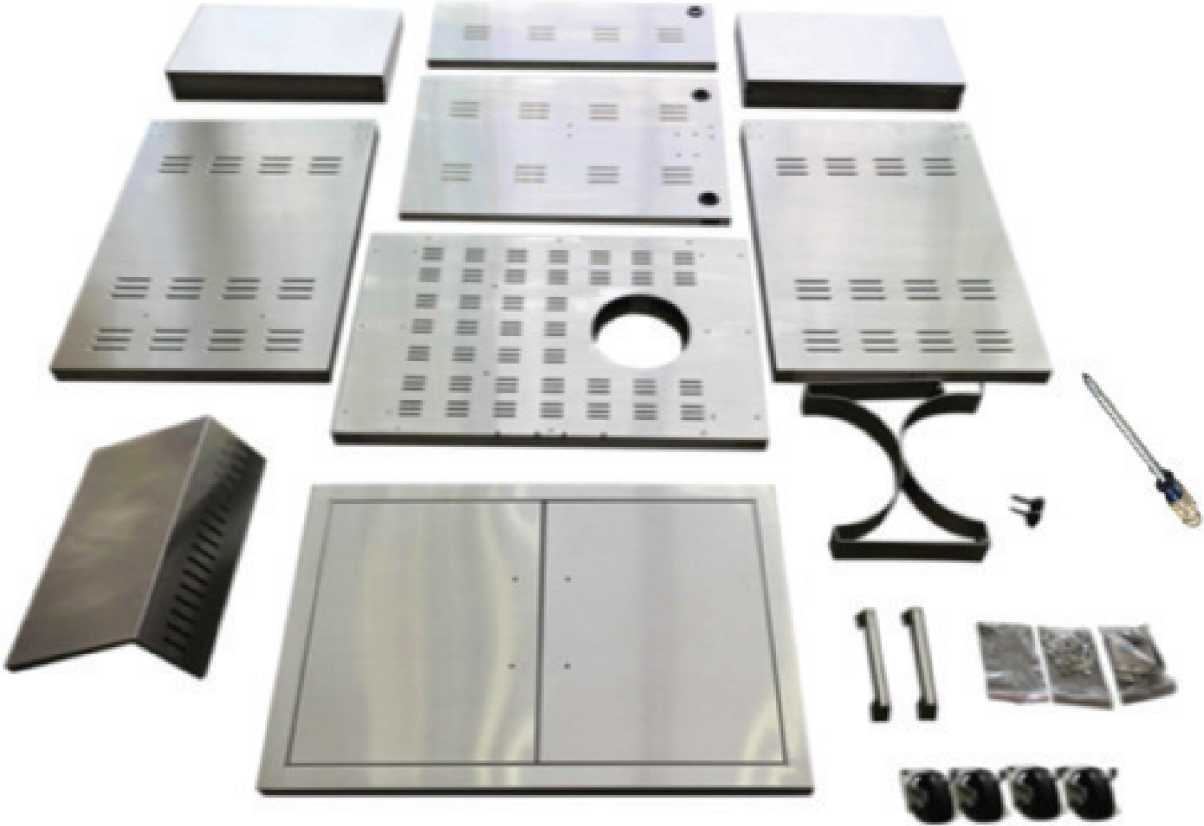

## 26" | 34" | 42" GRILL CART ASSEMBLY

# Hardware And Parts List

## HARDWARE:

1. M5x12 Screws 66 Pcs
2. M5 Flat Washers 71Pcs
3. M5x12 Countersunk Head Screws 17Pcs
4. Plum Screws 2Pcs
5. M4x8 Flat Head Screws 5 pcs  
(For Door Handle)
6. M4 Flat Washers 5Pcs (For Door Handle)
7. M4x10 Screw 4 pcs + M4 Hex Nut 4 pcs  
(For Transformer)
8. Screwdriver 1Pcs

## PARTS:

Description	Part No.
1. Locking Caster (4Pcs)	BR0036
2. Bottom Panel (1Pcs)	BR0037
3. Side Panel (3A Left)	BR0038
4. Side Panel (3B Right)	BR0039
5. Bottom Back Panel (1Pcs)	BR0040
6. Upper Back Panel (1Pcs)	BR0041
7. Step Panel (1Pcs)	BR0042
8. Tank Bracket With Ring (1Pcs)	BR0043
9. Door Handles (2Pcs)	BR0044
10. Assembled Door Unit (1Pcs)	BR0045
11. Side Shelves Brackets (4Pcs)	BR0046
12. Side Shelves (2Pcs)	BR0047

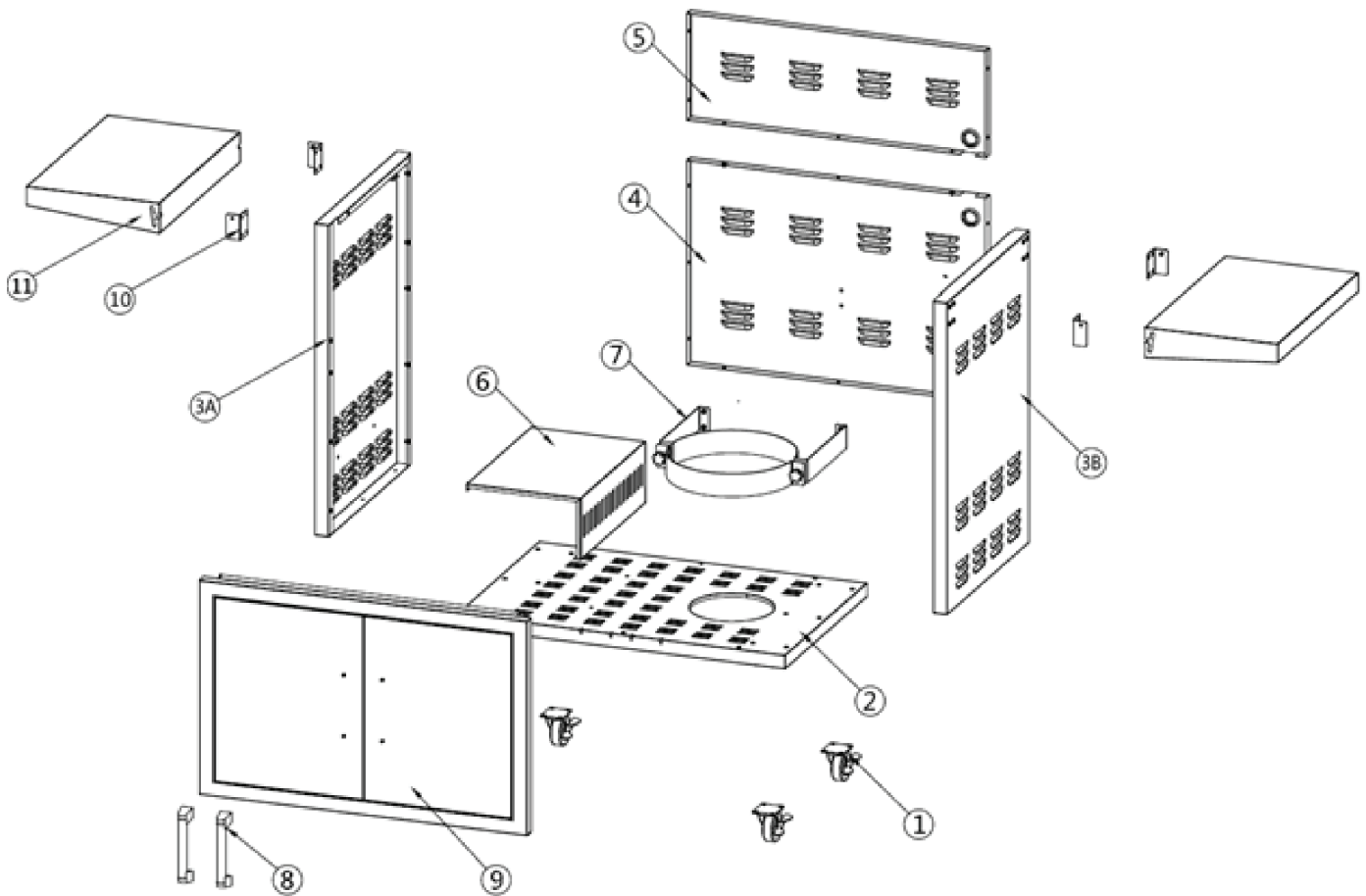

# Follow Steps 1 Through 5.

## STEP 1:

Remove all parts from the carton and please use an assistant to help in this cart assembly.

## STEP 2:

With the Bottom Panel #2 positioned upside down on a protective surface, attach all of the Locking Caster #1 using 4 pcs M5x12 screw and 4 pcs M5 flat washer on each.

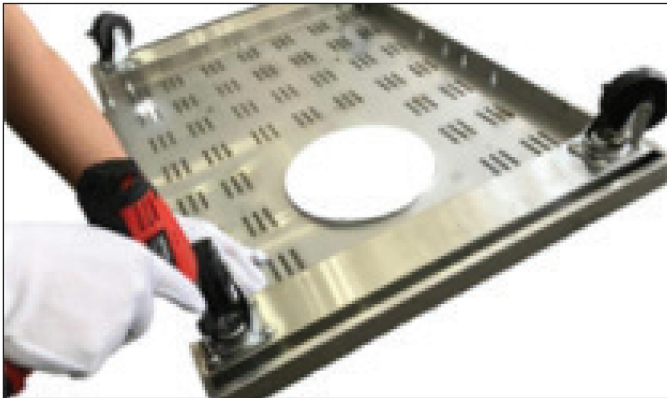

## STEP 3:

Attach the Right and Left Side Panel #3A and #3B to the Bottom Panel #2 by using 6pcs M5 x12 screw and 6pcs M5 flat washer. (The tank hole of Bottom Panel #2 is on the right side.)



## STEP 4:

Attach Bottom Back Panel #4 to the Side Panels (#3A & #3B) by using 6 pcs M5x12 screw and 6 pcs M5 flat washer and then to the Bottom Panel #2 by using 3 pcs M5x12 screw and 3 pcs M5 flat washer.

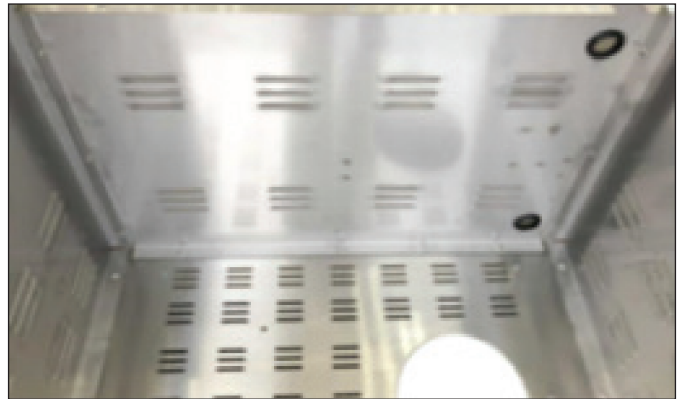

## STEP 5:

Attach Upper Back Panel #5 to the Side Panels (#3A and #3B) by using 4pcs M5 x12 screw and 4pcs M5 flat washer, and then to use 3pcs M5x12 screw and 3pcs M5 flat washer to be attached with Bottom Back Panel #4.



## Follow Steps 6 Through 8.

### STEP 6:

Attach Step Panel #6 to the Bottom Panel #2 by using 2 pcs M5x12 screw and 2 pcs M5 flat washer, and then to use 2 pcs M5x12 screw and 2 pcs M5 flat washer to be attached with Left Side Panel #3A



### STEP 7:

Attach the Tank Bracket with Ring #7 by using 2 pcs plum screw, and then to use 4 pcs M5x12 screw and 4 pcs M5 flat washer to be attached with Bottom Back Panel #4.



### STEP 8:

Attach the Assembled Door Unit #9 to the Right & Left Side Panel (#3A and #3B) by using 8 pcs M5x12 screw and 8 pcs M5 flat washer, and then to use another 3 pcs M5x12 screw and 3 pcs M5 flat washer to be attached with the Bottom Panel #2.



## Follow Steps 9 And 10.

### STEP 9:

Attach two Door Handles #8 to the assembled Door Unit 39 by using 4 pcs M4x8 screw and 4 pcs M4 flat washer

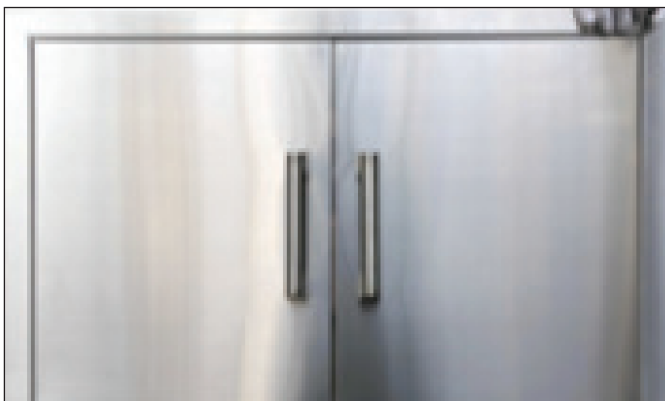

### STEP 10:

Attach 4 pcs Side Shelf Brackets #10 to the Right and Left Side Panels #3A & #3B by using 16 pcs M5x12 Countersunk Head Screw, and then attach a Side Shelf #11 to each Side Panel.

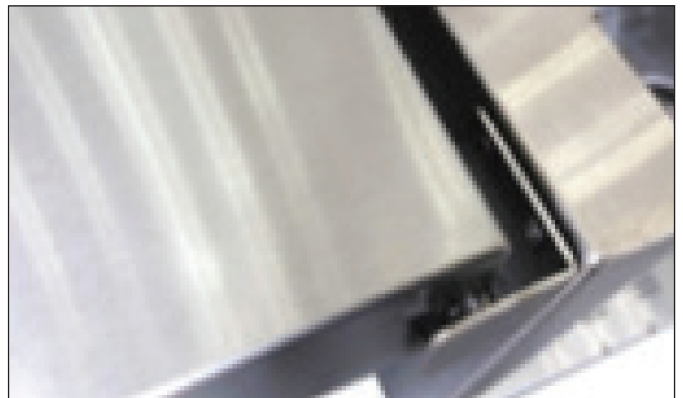

# Follow Step 11.

## STEP 11:

Finally, the barbecue is ready to be installed into the cart. Once installed, secure the barbecue head with 2 pcs M5x12 screw through the holes that are on each side, towards the front, on the inside of the firebox.

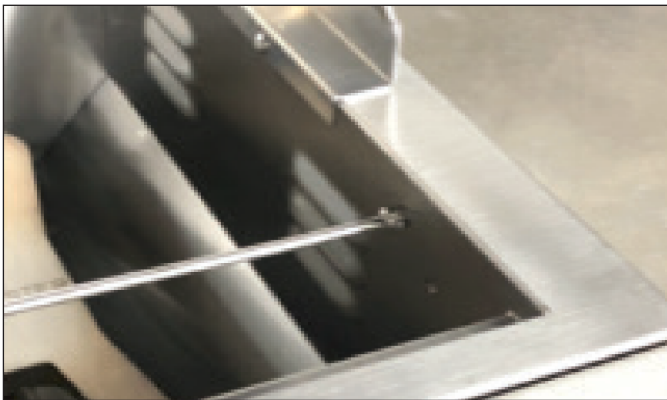

## NOTE 1:

The mounting holes in the Bottom Back Panel #4 are for mounting the transformer. (These holes are only for the BBQ head with lights.)

## NOTE 2:

The larger round holes in the Upper and Bottom Back Panel #4 & #5 are for the gas hose and the transformer wire.

## NOTE 3:

Some adjustments may be needed to properly position and level the cart. Make sure to tighten all screws with a screwdriver.



Installation Is Complete.



**BROILMASTER®**  
**PREMIUM GRILLS**

**BROILMASTER**

A Division of Empire Comfort Systems, Inc.  
918 Freeburg Ave.

Belleville, Illinois 62220

Visit our web site at [www.broilmaster.com](http://www.broilmaster.com)

If you have a general question about  
our products, please e-mail us  
at [info@empirecomfort.com](mailto:info@empirecomfort.com).

If you have a service or repair question,  
please contact your dealer.

