



DELUXE COUNTERTOP SERIES OUTDOOR GAS BARBECUE

INSTALLATION AND OPERATING INSTRUCTIONS

INSTALLER: Leave these instructions with consumer.
CONSUMER: Retain for future reference.



Unit before installation, with right grill absent to show flavor grid in place below. Oven/hood not shown.

INSET
Unit installed, with optional Oven/hood & warming rack.

IMPORTANT: READ THESE INSTRUCTIONS CAREFULLY BEFORE STARTING INSTALLATION OR USE.

SAFETY WARNINGS & CODES

⚠ DANGER:
IF YOU SMELL GAS:

1. Shut off the gas to the appliance.
2. Extinguish any open flame.
3. Open lid if equipped with an oven.
4. If odor continues, keep away from the appliance, and immediately call the gas supplier or fire department.

⚠ WARNING:

1. Do not store or use gasoline or other flammable vapors and liquids in the vicinity of this or any other appliance.
2. A propane cylinder, not connected for use, shall not be stored in the vicinity of this or any other appliance.

CODE AND SUPPLY REQUIREMENTS: This barbecue must be installed in accordance with local codes and ordinances, or, in the absence of local codes, with either the latest *National Fuel Gas Code (ANSI Z223.1/NFPA 54)*, and *Natural Gas and Propane Storage and Handling Installation Code (CSA-B149.1)*.

⚠ WARNING
Improper installation, adjustment, alteration, service, or maintenance can cause injury or property damage. Refer to this manual. For assistance or additional information, consult a qualified professional installer, service agency, or the gas supplier.

This appliance and its individual shutoff valves must be disconnected from the gas supply piping system when testing the system at pressures in excess of ½ psig (3.5 kPa).

This appliance must be isolated from the gas supply piping system by closing its individual manual shutoff valves during any pressure testing of the gas supply system at pressures up to and including ½ psig (3.5 kPa).

All electrical outlets in the vicinity of the barbecue must be properly grounded in accordance with local codes or, in the absence of local codes, with the *National Electrical Code, ANSI/NFPA 70*, or the *Canadian Electrical Code, CSA C22.1*, whichever is applicable.

Keep all electrical supply cords and fuel supply hoses away from any heated surface.



**Certified to ANSI: Z21.58-2005 /
CSA 1.6-2005**



BARBECUE EXTÉRIEUR DE GAZ DE SÉRIE DELUXE DE COUNTERTOP

INSTALLATION ET CONSIGNES D'UTILISATION

INSTALLATEUR : Laissez ces instructions avec le consommateur.

CONSOMMATEUR : Maintenez pour la future référence.

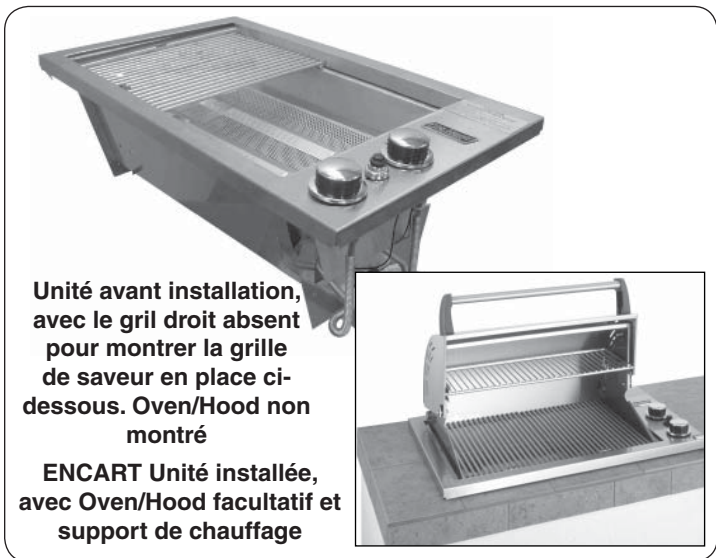

Unité avant installation, avec le gril droit absent pour montrer la grille de saveur en place ci-dessous. Oven/Hood non montré

ENCART Unité installée, avec Oven/Hood facultatif et support de chauffage

IMPORTANT: LISEZ CES INSTRUCTIONS SOIGNEUSEMENT AVANT DE COMMENCER L'INSTALLATION

AVERTISSEMENTS ET CODES DE SÛRETÉ

⚠ DANGER

S'il y a une odeur de gaz:

1. Coupez l'admission de gaz de l'appareil.
2. Éteindre toute flamme nue.
3. Ouvrir le couvercle.
4. Si l'odeur persiste, gardez loin de l'appareil, et appelez immédiatement le fournisseur de gaz ou le service d'incendie.

CONDITIONS DE CODE ET D'APPROVISIONNEMENT:

Ce barbecue doit être installé selon des codes et des ordonnances locaux, ou, en l'absence des codes locaux, avec l'un ou l'autre le plus défunt code national de gaz de carburant (norme ANSI Z223.1/NFPA 54), et stockage de gaz naturel et de propane et manipulation du code d'installation (CSA-B149.1).

Cet appareil et ses différents robinets d'isolement doivent être démontés du système sifflant d'offre de gaz en examinant le système aux pressions au-dessus du 1/2 psig (kPa 3.5).

Cet appareil doit être isolé dans le système sifflant d'offre de gaz par fermeture ses différents robinets d'isolement manuels pendant tous les essais sous pression du circuit d'alimentation de gaz aux pressions jusques et y compris le 1/2 psig (kPa 3.5).



Certifié à la norme ANSI: Z21.58-2005 / CSA 1.6-2005

⚠ AVERTISSEMENT

1. Ne pas entreposer ni utiliser de l'essence ni d'autres vapeurs ou liquides inflammables dans le voisinage de l'appareil, ni de proximité de tout autre appareil.
2. Une bouteille de propane qui n'est pas raccordée en vue de son utilisation, ne doit pas être entreposée dans le voisinage de cet appareil ou de tout autre appareil.

AVERTISSEMENT

L'installation inexacte, l'ajustement, le changement, le service ou l'entretien peuvent causer des dommages ou des dégâts matériels. Référez-vous à ce manuel. Pour l'aide ou l'information additionnelle consultez un installateur qualifié et professionnel, l'agence de service, ou le fournisseur de gaz.

Toutes les sorties électriques à proximité du barbecue doivent être correctement fondues selon des codes locaux ou, en l'absence des codes locaux, avec le code électrique national, ANSI/NFPA 70, ou le code électrique canadien, CSA C22.1, qui est jamais applicable.

Gardez tout cordon d'alimentation électrique et tuyau d'alimentation en combustible à l'écart des surfaces chauffées.

TABLE OF CONTENTS

- 1 SAFETY WARNINGS & CODES
- 3 PRODUCT DATA TABLE
- 5 PARTS LIST
- 7 SAFE USE & MAINTENANCE OF PROPANE-GAS CYLINDERS
- 8 PLANNING FOR INSTALLATION
- 8 INSTALLATION
- 10 CHECKING AND CONVERTING GAS TYPE
- 10 CHECKING AND CONVERTING THE REGULATOR
- 11 AIR SHUTTER ADJUSTMENT
- 11 MAIN BURNER AIR SHUTTER ADJUSTMENT
- 12 BARBECUE SAFETY INFORMATION & MAINTENANCE
- 12 DRIP COLLECTION SYSTEM
- 13 LIGHTING (IGNITION) INSTRUCTIONS
- 15 TROUBLESHOOTING
- 15 REPLACING THE IGNITOR BATTERY
- 16 ACCESSORIES
- 17 CARE & CLEANING
- 17 COVER
- 18 WARRANTY

PRODUCT DATA TABLE

Specification	Value
Counter opening height*	14" (35.6 cm)
Counter opening width*	29 1/2" (74.9 cm)
Counter opening depth*	16 1/2" (41.9 cm)
Main Burner	
BTU per burner	21,000 (6.2 kw) x 2
Natural gas orifice	#44 (2.184 mm)
Propane gas orifice	#55 (1.321 mm)
Infrared Burner	
	(if equipped)
BTU per burner	28,000 (8.2 kw)
Natural gas orifice	#53 (1.511 mm)
Propane gas orifice	#58 (1.067 mm)

Table 1 - Product data table

***Note:** If using an insulating liner, consult liner instructions for counter cut-out dimensions.

Avertissements généraux :

- Ce barbecue est pour utilisation à l'extérieur seulement. Si l'appareil est entreposé à l'intérieur, enlever les bouteilles et les laisser à l'extérieur.
- Ne pas ranger le gril immédiatement après l'avoir utilisé. Le laisser refroidir avant de le déplacer ou de la ranger. Le non respect de cette mesure de sécurité pourrait entraîner un incendie causant des dommages à la propriété, des blessures ou la mort.
- Ne pas utiliser cet appareil sous une surface combustible.
- Ne pas utiliser cet appareil sous un auvent. Le non respect de cette mesure de sécurité pourrait entraîner un incendie ou des blessures.
- Dégagement minimal entre les parois latérales et l'arrière de l'appareil et la construction combustible (45.7 cm à partir des parois latérales et 45.7cm à partir de l'arrière).
- Le régulateur de pression de gaz prévu avec cet appareil de cuisson à gaz pour l'extérieur doit être utilisé. Ce régulateur est réglé pour une pression de sortie de 5 pouces de colonne de l'eau pour le gaz naturel, et 10 pouces pour le propane.
- LE RÉGULATEUR INCLUS D'APPAREILS EST ÉVALUÉ POUR LE MAXIMUM DE 1/2 (LIVRES PAR POUCE CARRÉ). SI VOTRE OFFRE DE GAZ EST 1/2 PLUS GRAND QUE (LIVRES PAR POUCE CARRÉ), UN RÉGULATEUR ADDITIONNEL DOIT ÊTRE INSTALLÉ AVANT LE BARBECUE. VOIR LA SECTION DE CONDITIONS D'OFFRE DE GAZ POUR LA PRESSION APPROPRIÉE D'OFFRE DE GAZ.
- Ne couvrez jamais la surface entière de cuisine ou de gril de gauffreuses ou de casseroles. La surchauffe se produira et les brûleurs ne seront pas très performants quand la chaleur de combustion est emprisonnée au-dessous de la surface à cuire.
- Ne pulvérisez jamais l'eau sur une unité chaude de gaz, comme ceci peut endommager des composants de porcelaine ou de fer de fonte.

Avertissements de propane :

- Une fuite de GPL peut causer un incendie ou une explosion si enflammée entraînant des blessures corporelles graves ou la mort.
- Communiquez avec le fournisseur de GPL pour les réparations ou pour disposer de qu'une bouteille ou du GPL non utilisé.

PARTS LIST

Item	Description	Part No.	Qty.
1.	Stainless steel cooking grid or Porcelain steel rod 16" x 11 1/2" or Porcelain cast iron 16" x 11 1/2"	3537-S-2 3537-2 3528-2	1 1 1
2.	Flavor grid 10" X 17"	3053S	1
3.	Burner	3041-40-2	2
4.	Top control panel	3220-09	1
5.	Valve manifold assembly	3220-13	2
6.	Burner clip	3270-06-2	2
7.	Electrode assembly w/ wiring	3199-61	1
8.	Air shutter	3201-04	2
9.	Air shutter spring	3048-03-2	2
10.	Ignitor assembly	3199-47	1
11.	Control knob	3018	2
12.	Orifice, propane gas or Orifice, natural gas	3001-55-2 3001-47-2	2 2
13.	Oven assembly	3731	1

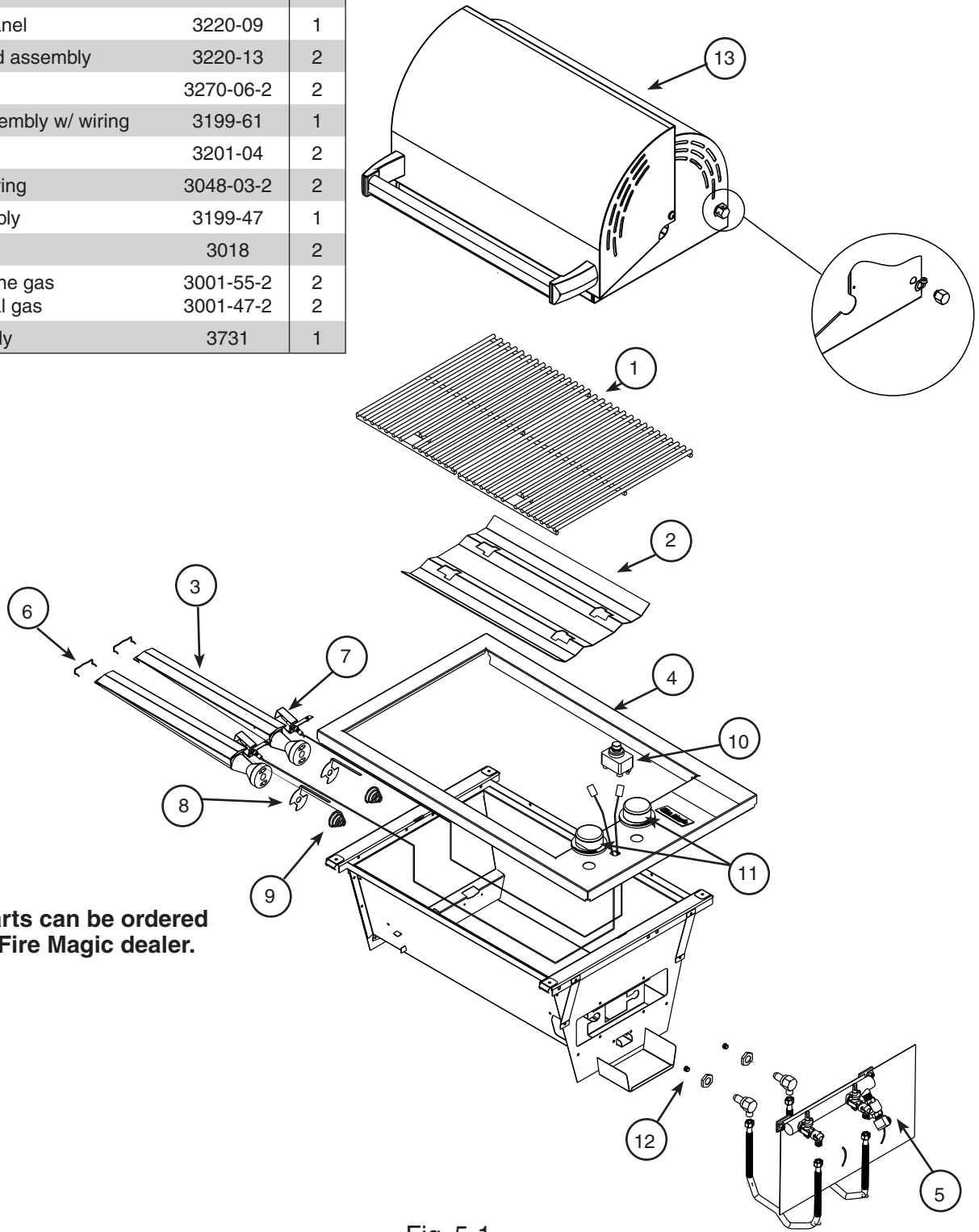

Replacement parts can be ordered from your local Fire Magic dealer.

Fig. 5-1

UTILISATION SÛRE ET ENTRETIEN DES CYLINDRES DE GAZ DE PROPANE

IMPORTANT POUR VOTRE SÛRETÉ

LISEZ ET SUIVEZ TOUS LES AVERTISSEMENTS ÉQUIPÉS DE VOTRE CYLINDRE DE GAZ DE PROPANE.

En actionnant cet appareil avec un cylindre de gaz de propane ON DOIT observer ces instructions et avertissements.

LE MANQUE DE FAIRE AINSI PEUT AVOIR COMME CONSÉQUENCE UNE INCENDIE OU UNE EXPLOSION SÉRIEUSE.

CYLINDRE ET CONDITIONS ET

CARACTÉRISTIQUES DE CONNECTEUR

- Des cylindres et les valves de gaz de propane doivent être maintenus en bon état et doivent être remplacés s'il y a des dommages évidents au cylindre ou à la valve.
- Ce gril, une fois utilisé avec un cylindre, devrait être relié à un gallon de la norme 5 (20lb.) cylindre de gaz de propane équipé d'un OPD (remplissez au-dessus du niveau le dispositif d'empêchement). L'OPD a été exigé sur tous les cylindres vendus depuis octobre 1.1998 pour empêcher le remplissage excessif.
- Les dimensions de cylindre devraient être approximativement 12" (30.5cm) de diamètre et 18" (45.7cm) hauts. Des cylindres doivent être construits et marqués selon les caractéristiques pour des cylindres de gaz de propane du département des ETATS-UNIS du transport (D.O.T.) ou le niveau national du Canada, du CAN/CSA-B339, des cylindres, des sphères et des tubes pour le transport des marchandises dangereuses.
- Le cylindre doit inclure un collier pour protéger la valve de cylindre et le circuit d'alimentation de cylindre doit être assuré le retrait de vapeur.
- L'ensemble régulateur et le tuyau de pression (Fig. 6-1) fourni avec cet appareil de gaz à l'extérieur (certains modèles LP seulement) doit être utilisé. Assemblages originaux et régulateur de pression de remplacement et le tuyau doivent être celles qui sont spécifiées par le fabricant pour la connexion avec un dispositif de connexion cylindre identifiée comme de type I par l'ANSI Z 21.58-2005/CGA 1,6 à 2005 (voir liste des pièces de commande).
- La valve de cylindre de gaz de propane doit être équipée d'un dispositif d'accouplement de raccordement de cylindre, décrit comme type I dans la norme définie dans le e. de paragraphe ci-dessus. Ce dispositif est généralement décrit comme coupleur rapide de fil de point culminant.
- Si votre cylindre de gaz de propane vient avec une prise de la poussière, placez le bouchon anti-poussière sur la sortie de valve de cylindre toutes les fois que le cylindre n'est pas en service.

OPÉRATION DE COUPLEUR RAPIDE

Pour relier le régulateur/hose à l'ajustage de précision de valve de cylindre de gaz de propane: Serrez l'écrou de main sur le régulateur au-dessus de l'ajustage de précision de fil de point culminant sur la valve de cylindre. Tournez l'écrou de

main dans le sens des aiguilles d'une montre pour engager les fils et pour serrer jusqu'à ce que douillettement. L'utilisation des pinces ou de la clé ne devrait pas être nécessaire. Seulement le propane marqué par cylindres doit être employé.

Pour débrancher: Tournez l'écrou de main dans le sens contraire des aiguilles d'une montre jusqu'à isolé (fig. 6-1).

Important: Avant d'employer le gril, et ensuite chaque fois que le cylindre est enlevé et rattaché, examinez tous les raccordements pour déceler les fuites. Arrêtez les valves de gril et ouvrez la valve principale de cylindre, puis vérifiez les raccordements avec de l'eau savonneuse. Réparez toutes les fuites avant d'allumer le gril.

ATTENTION: Tournez toujours la valve principale de cylindre de propane au loin après chaque utilisation, et avant de déplacer le gril et le cylindre, ou débrancher l'accouplement. Cette valve doit rester fermée et le cylindre a débranché alors que l'appareil n'est pas en service, quoique l'écoulement de gaz soit arrêté par un dispositif de sûreté quand le coupleur est débranché.

Inspectez soigneusement l'ensemble de tuyau chaque fois avant que le gaz soit allumé. Un tuyau fissuré ou effiloché doit être immédiatement remplacé.

Si l'appareil est stocké à l'intérieur, le cylindre doit être disconnected et a enlevé. Des cylindres Disconnected doivent être stockés dehors, hors de la portée des enfants, avec les prises de valve filettées étroitement installées, et ne doivent pas être stockés dans un bâtiment, le garage, ou n'importe quel autre secteur inclus.

POUR VOTRE SÛRETÉ

- Ne stockez pas un cylindre de gaz disponible de propane dessous ou ne vous approchez pas de cet appareil.
- Ne remplissez jamais cylindre au delà de 80 pour cent de plein.
- SI L'INFORMATION DANS "A" ET "B" N'EST PAS SUIVIE EXACTEMENT, UN FEU CAUSANT LA MORT OU DES DOMMAGES SÉRIEUX PEUT SE PRODUIRE.

Fig. 6-1 type coupleur rapide de fil de point culminant d'I

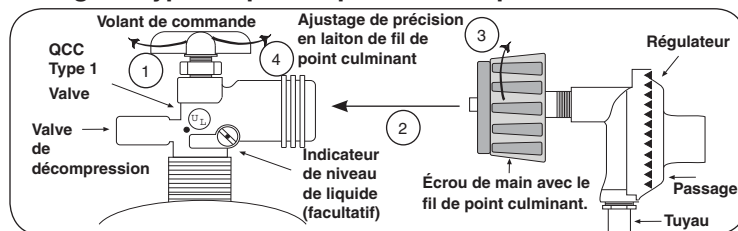

CONDITIONS DE CLÔTURE

POUR VOTRE SÉCURITÉ, vous devez fournir les ouvertures énumérées ci-dessous pour le drainage, l'air de remplacement, et une ventilation transversale d'une zone de stockage exposés à une fuite possible des raccordements de gaz, l'unité, ou de bouteilles de propane.

Un côté de l'enceinte peut être complètement ouvert sur l'extérieur, ou 4 ouvertures de ventilation doivent être créés:

Deux des ouvertures doivent être au niveau robinet de la bouteille (environ 16 "au-dessus du sol) et sur des parois opposées de l'enceinte. 2 ouvertures plus doit être au niveau du sol (env. 5 "au-dessus du sol) et sur les côtés opposés de l'enceinte. Chaque ouverture doit avoir un minimum de 10 pouces carrés de surface libre. Pour parvenir à la bonne ventilation, vous pouvez percer une série de trous, omettez le coulis de joints de maçonnerie, ou de remplacer une brique avec un écran de toile métallique. Si le plancher de l'armoire est soulevée et l'espace situé sous le caisson est ouvert vers l'extérieur, les ouvertures d'aération inférieures peuvent être dans le sol.

Consultez votre fournisseur de gaz pour les besoins de ventilation et de régulateur lors de la connexion à une alimentation en propane des ménages.

SAFE USE & MAINTENANCE OF PROPANE GAS CYLINDERS

IMPORTANT FOR YOUR SAFETY

READ AND FOLLOW ALL WARNINGS PROVIDED WITH THE PROPANE-GAS CYLINDER.

When operating this appliance with a propane-gas cylinder, these instructions and warnings **MUST** be observed.

FAILURE TO DO SO MAY RESULT IN A SERIOUS FIRE OR EXPLOSION.

CYLINDER/CONNECTOR REQUIREMENTS

- Propane-gas cylinders, valves, and hoses must be maintained in good condition and must be replaced if there is visible damage to either the cylinder or valve. If the hose is cut or shows excessive abrasion or wear, it must be replaced before using the gas appliance (see **e.**).
- This unit, when used with a cylinder, should be connected to a standard 5-gallon (20 lb.) propane-gas cylinder equipped with an OPD (Overfill Prevention Device). The OPD has been required on all cylinders sold since October 1, 1998, to prevent overfilling.
- Cylinder dimensions should be approximately 12" (30.5 cm) in diameter and 18" (45.7 cm) high. Cylinders must be constructed and marked in accordance with the *Specifications for Propane Gas Cylinders of the U.S. Department of Transportation (D.O.T.)* or the National Standard of Canada, *CAN/CSA-B339, Cylinders, Spheres, and Tubes for Transportation of Dangerous Goods*.
- The cylinder used must include a collar to protect the cylinder valve, and the cylinder supply system must be arranged for vapor withdrawal.
- The pressure regulator and hose assembly (Fig. 7-1) supplied with this outdoor gas appliance (select L.P. models only) must be used. Original and replacement pressure regulator and hose assemblies must be those specified by the manufacturer for connection with a cylinder connecting device identified as Type I by the *ANSI Z 21.58-2005/CGA 1.6-2005* (see PARTS LIST for ordering information).
- The propane-gas cylinder valve must be equipped with a cylinder connection coupling device, described as Type I in the standard defined in paragraph **e.** above. This device is commonly described as an Acme thread quick coupler.
- If the propane-gas cylinder comes with a dust plug, place the dust cap on the cylinder valve outlet whenever the cylinder is not in use.

QUICK COUPLER OPERATION

To connect the regulator/hose assembly to the propane-gas cylinder valve fitting: Press the hand nut on the regulator over the Acme thread fitting on the cylinder valve. Turn the hand nut clockwise to engage the threads and tighten until snug.

The use of pliers or a wrench should not be necessary. Only cylinders marked "propane" may be used.

To disconnect: Turn the hand nut counterclockwise until detached (Fig. 7-1).

Important: Before using the unit, and after each time the cylinder is removed and reattached, check the hose for wear (see **a.**) and check all connections for leaks. Turn off the unit valves and open the main cylinder valve, then check connections with soapy water. Repair any leaks before lighting the unit.

CAUTION: Always turn the propane cylinder main valve off after each use, and before moving the unit and cylinder or disconnecting the coupling. This valve must remain closed and the cylinder disconnected while the appliance is not in use, even though the gas flow is stopped by a safety feature when the coupler is disconnected.

Carefully inspect the hose assembly each time before the gas is turned on. A cracked or frayed hose must be replaced immediately.

If the appliance is stored indoors, the cylinder must be disconnected and removed. Disconnected cylinders must be stored outdoors, out of the reach of children, with threaded valve plugs tightly installed, and must not be stored in a building, garage, or any other enclosed area.

FOR YOUR SAFETY

- DO NOT store a spare propane-gas cylinder under or near this appliance.
- NEVER fill the cylinder beyond 80-percent full.
- IF THE INFORMATION IN **a.** AND **b.** IS NOT FOLLOWED EXACTLY, A FIRE CAUSING DEATH OR SERIOUS INJURY MAY OCCUR.

Fig. 7-1 Type I Acme thread quick coupler

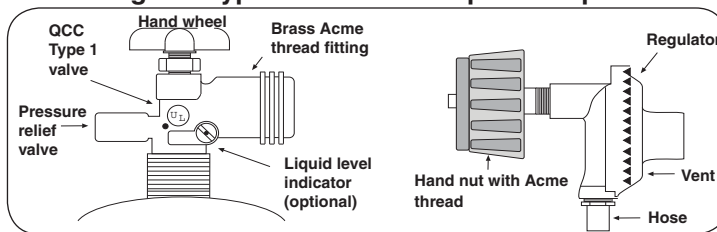

ENCLOSURE REQUIREMENTS

FOR YOUR SAFETY, you must provide the openings listed below for drainage, replacement air, and cross-ventilation of any storage area exposed to possible leakage from gas connections, the unit, or propane cylinders.

One side of the enclosure can be left completely open to the outside, OR 4 ventilation openings must be created:

Two of the openings are to be at the cylinder valve level (approx. 16" above the floor) and on opposite walls of the enclosure. 2 more openings must be at the floor level (approx. 5" above the floor) and on opposite sides of the enclosure. Each opening must have a minimum of 10 sq. in. of free area. To achieve the proper ventilation, you may drill a series of holes, omit the grout from masonry joints, or replace a brick with a hardware cloth screen. If the floor in the cabinet is raised and the space beneath the cabinet is open to the outside, the lower ventilation openings may be in the floor.

Consult your gas supplier for ventilation and regulator requirements when connecting to a household propane supply.

PLANNING FOR INSTALLATION

This barbecue is designed for outdoor use only.

DO NOT use this unit under unprotected flammable surfaces. DO NOT use this appliance inside a building, garage, or any other covered area (see EXHAUST REMOVAL). DO NOT use this barbecue in or on a recreational vehicle or boat.

WARNING

Built-in models must be installed in masonry or other type of fireproof enclosure, unless an insulating liner is purchased from the manufacturer. The unit alone is not insulated, and therefore must be installed with 18" (45.7 cm) of side, front, and back clearance from unprotected combustible materials, such as wood, plastic, or stucco with wood framing.

This barbecue must be installed so that it can be removed in the event service should be necessary. Any protrusion into the barbecue enclosure from either side, which is less than 14" from the countertop, may obstruct the frame and prevent the unit from dropping into place (see GAS SUPPLY PLUMBING REQUIREMENTS)

EXHAUST REMOVAL

If installed under a patio roof, the cooking grid area should be fully covered by a chimney and exhaust hood. An exhaust fan with a rating of at least 1,000 CFM (472 liters per second) is necessary to efficiently remove smoke and other cooking by-products from the covered area. This barbecue shall not be used under unprotected overhead combustible construction. Do not install in a fully enclosed area of any kind.

GAS SUPPLY PLUMBING REQUIREMENTS

Rigid 1/2" (1.3 cm) black steel pipe is required to conduct the gas supply into the barbecue enclosure for connection to the unit. Where required, use pipe joint compound which is resistant to all gases should be applied to all male fittings and all joints tightened securely. Do not use pipe joint compound to connect flare fittings.

The pipe should terminate near the right rear of the enclosure, no more than 10" (25.4 cm) from the counter top. Installation will be simplified if the pipe enters the enclosure vertically from the bottom and no more than 6" (15.2 cm) from the right side or rear wall (Fig. 8-1).

If the pipe does not come up against the right wall, it can easily be run along the enclosure floor and turned up to rise within 10" (25.4 cm) of the counter top, against right wall (leaving space only to connect fittings, Fig. 8-2).

CAUTION: An external valve in the gas line is necessary for safety when the barbecue is not in use. It also provides for convenient maintenance and repair. A removable key is recommended.

GAS SUPPLY AND MANIFOLD PRESSURE

Natural Gas - Normal 7" (17.8 cm) Water Column, Minimum 5" (12.7 cm), Maximum 10 1/2" (26.7 cm).

Propane Gas - Normal 11" (27.9 cm) Water Column, Minimum 8" (20.3 cm), Maximum 13" (33 cm).

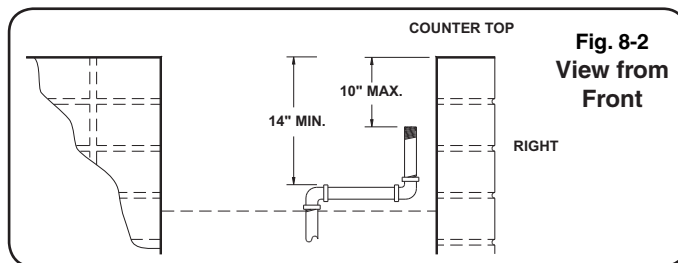
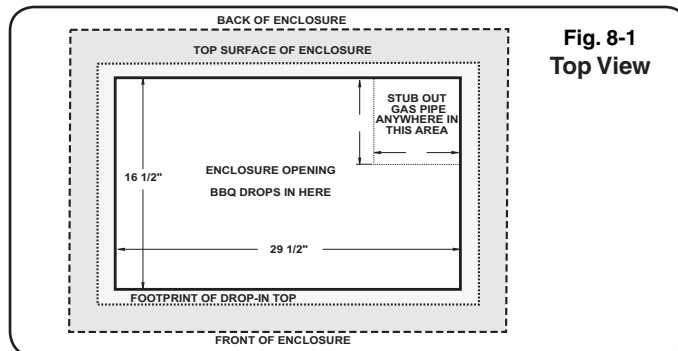

CAUTION: Wind blowing into or across the rear oven lid vent can cause poor performance and/or dangerous overheating. Orient the grill so that the prevailing wind blows toward the front of the grill (Fig. 8-3).

CAUTION: To prevent dangerous overheating, the rear of the unit must have a minimum clearance of 8" from any backsplash/wall.



INSTALLATION

Perform the following checks before installing the barbecue:

1. CHECK FUEL ORIFICES FOR PROPER SIZE

Fire Magic barbecues are equipped with orifices for natural gas unless otherwise indicated. For use with propane gas, smaller orifices must be installed to avoid hazardous overheating.

2. IF YOU ARE NOT SURE YOU HAVE THE CORRECT BARBECUE BURNER ORIFICE SIZE

a. Remove the cooking grids and flavor grid from the barbecue, and where fitted, the oven/hood.

b. If the gas supply has been connected, make sure the burner valve is in the **OFF** position. Then pull the knobs from their stems. Lift the drop-in top and remove it from the barbecue. You will need to pull up on the corners to release the top from spring clips.

c. Check the orifice size by removing the burner clips and pulling the burner away from the orifice. The drill size is stamped on the face of each orifice. Be sure not to lose the air shutter or air shutter spring, which may become detached when the burner is removed. (Refer to Table 1 for correct orifice size).

INSTALLATION (cont.)

- d. Change all orifices if necessary, following instructions provided with the replacement orifices (furnished with all Fire Magic gas barbecues).
- e. After checking orifice drill size, carefully replace the burners on the pegs so the brass orifice and orifice holder fittings project well into the burners. The air shutter springs and air shutters should be installed over the orifice holder fitting, between the burner and the pipe manifold, in the order and in the position pictured below (Fig. 9-1).

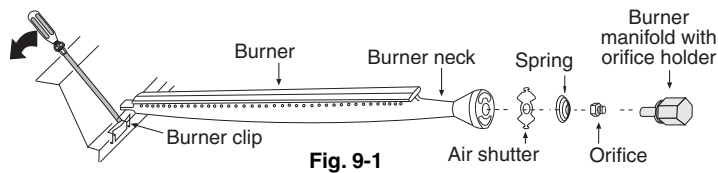

Fig. 9-1

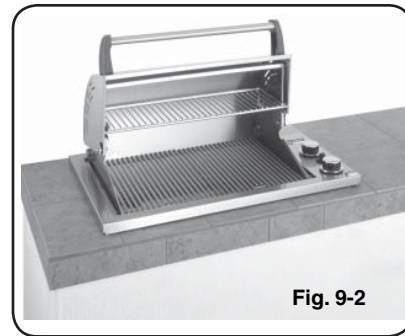

Fig. 9-2

3. CONNECT THE GAS SUPPLY TO BARBECUE

- a. A C.S.A. approved stainless steel flex connector will be needed to bring the gas supply from the gas line stub to the valve manifold. A 1/2" (1.3 cm) x 24" (61 cm) flex stainless steel connector is suitable for most installations. A 1/2" (1.3 cm) female flare fitting is required to connect to the unit. **ONLY LISTED STAINLESS STEEL CONNECTORS** should be used to connect the barbecue to the gas line inside the enclosure.

CAUTION: Use only stainless steel flex connectors that are C.S.A. listed.

WARNING: A rubber or plastic connector will rupture or leak, resulting in an explosion or serious injury if used inside the barbecue enclosure.

- b. **Verify that the gas supply is turned off.** Then connect the 1/2" (1.27 cm) pipe adapter fitting supplied with the stainless steel flex connector to the gas supply stub. Use pipe joint compound that is resistant to all gasses on the male pipe fitting and tighten securely. Do not use pipe joint compound to connect the flare fittings.
- c. Lower the barbecue into place, making sure not to pinch or kink the gas connector. The unit will rest on the counter (Fig. 9-2).
- d. Connect the flex connector to the flare fitting on the manifold inlet. Support the manifold inlet fitting with a wrench to avoid applying excessive torque to the manifold assembly while tightening this connection securely. Do not use pipe compound on flare fittings.

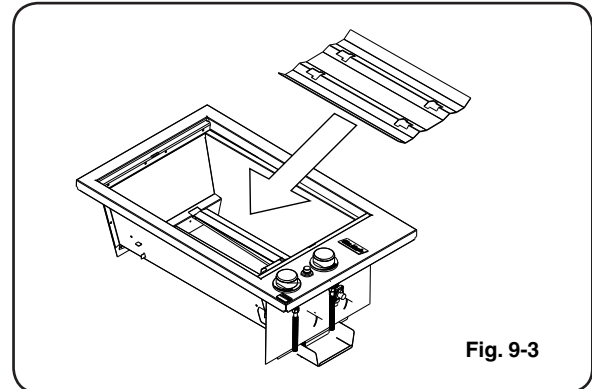

Fig. 9-3

- e. Starting with the barbecue burner valve in the **OFF** position, turn the gas supply on. Carefully, check all gas connections for leaks with a brush and soapy water before lighting.

NEVER USE A MATCH OR OPEN FLAME TO TEST FOR LEAKS.

- f. Refer to the **AIR SHUTTER ADJUSTMENT** section before replacing barbecue control panel and knobs.

4. INSTALL THE FLAVOR GRID

- a. Place the flavor grid directly on the burners. Make sure the legs (on the underside) of the grid rests on the burners (Fig. 9-3), centering the grid over the burners with the open side up. This allows heat from the burners to be evenly distributed throughout the cooking area. The flavor grid heats and cools quickly, making the Fire Magic barbecue very responsive to the changes you specify in grill temperature.

The flavor grid is made of stainless steel and is rust resistant. It may be cleaned with standard oven cleaners.

DRIP COLLECTOR INSTALLATION

The drip collector is located below the manifold (see Parts List). To gain access to this area in order to empty or change the drip receptacle, a small access door in the barbecue island or enclosure is required.

To install the drip collector, place the hooks of the collector tray into the slots (located at the bottom of the barbecue, below the manifold). Press down to fasten securely. Place the drip receptacle on the tray below the drip chute (Fig. 9-4).

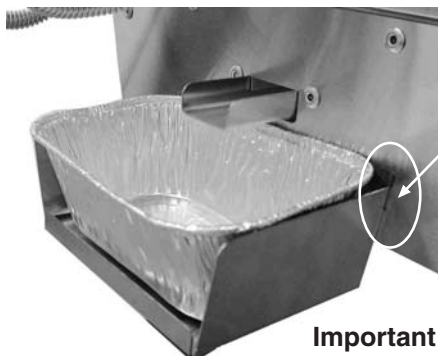

Hook the drip collector tray into the slots and push down. Place the drip receptacle on tray.

Fig. 9-4

Important: Check and clean the drip tray after each use.

CHECKING AND CONVERTING GAS TYPE

This unit comes from the factory configured for one type of gas, as marked on the label located behind the control panel, or on the interior of the unit's enclosure.

Converting this unit to burn a different type of gas requires a conversion kit (contact your dealer for details). The professional installer who converts this unit to burn a different gas must perform the following functions:

1. Change brass gas orifices (included at original shipping) on each burner to match the new gas type (see PRODUCT DATA TABLE, Table 1).
2. Switch the convertible gas regulator (if equipped) to match the new gas type (see section below).
3. Plumb the unit as appropriate for the new gas supply.
4. Apply the label for the new gas (included at original shipping) over the old gas information found on your unit.

WARNING

HAZARDOUS OVERHEATING WILL OCCUR IF A NATURAL-GAS ORIFICE IS USED WITH PROPANE GAS. IF YOU ARE NOT SURE IF THE CORRECT ORIFICES ARE INSTALLED, OR IF AN ORIFICE CHANGE IS NECESSARY, REFER TO THE FOLLOWING INSTRUCTIONS.

CAUTION: Make sure the unit is at a safe temperature and isolated from gas and electrical supplies before beginning the tasks outlined below.

Note: The cooler the unit, the greater the tolerances between the stainless-steel parts, and therefore the easier to disassemble and reassemble parts of the unit.

CAUTION: For your safety, exercise caution and use adequate hand protection (such as gloves) when handling potentially sharp sheet-metal parts.

CHECKING AND CONVERTING THE REGULATOR

Regulator: note cap on top

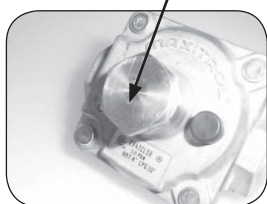

Note: Each end of the plastic converter is engraved with either the letters "NAT" or "L.P." (propane) for the respective gasses. When the converter is in the cap and the cap is held uppermost, the letters seen indicate the gas that the regulator is set up for.

To convert the regulator from one gas to another, follow steps 1-4.

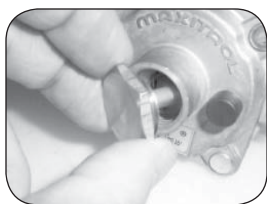

STEP 1: Unscrew and remove the cap from the regulator, extracting the converter.

Read gas type here



STEP 3:

Turn the converter around and replace it carefully, into the center of the cap (it will snap into place). Check that you can read the type of gas the unit is set for.



STEP 2:

Remove the converter (the plastic stalk) by carefully pulling it away from the center of the cap (it will snap out of its seating).

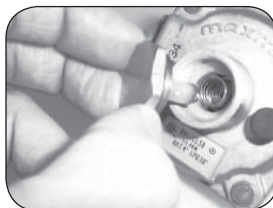

STEP 4:

Replace the unit into the regulator and screw down until snug.

WARNING

THIS APPLIANCE REGULATOR IS RATED FOR 1/2 PSI MAXIMUM. IF YOUR GAS SUPPLY IS GREATER THAN 1/2 PSI, AN ADDITIONAL REGULATOR MUST BE INSTALLED TO REDUCE THE INPUT PRESSURE TO THE UNIT TO 1/2 PSI OR LESS. SEE GAS-SUPPLY REQUIREMENTS SECTION FOR PROPER GAS-SUPPLY PRESSURE.

AIR SHUTTER ADJUSTMENT

MAIN BURNER AIR SHUTTER ADJUSTMENT

Important: The air shutters must be adjusted after installation. If not, this appliance may not light, heat evenly, or cook properly.

Main burner air shutters are easily accessed by removing (when cool) the valve control knobs, and the counter top cover. Carefully disconnect the spark ignitor wiring when removing the cover (see PARTS LIST). The air shutter has a small dimple (see Fig. 11-1) that allows it to lock into notches in the burner face. This prevents the air shutter from moving.

WARNING

USE PROPERLY INSULATED TOOLS TO MAKE THESE ADJUSTMENTS. NEVER TOUCH A HOT BARBECUE DIRECTLY TO MAKE ADJUSTMENTS.

1. **Using the tip of a long screwdriver**, close the air shutters by turning the tabs to a vertical position (Fig. 11-2).
2. Light the barbecue in accordance with the LIGHTING INSTRUCTIONS and burn for two minutes with the knobs on **HI LIGHT** and the oven open.
3. After burning for two minutes, open the air shutters, **using the tip of a screwdriver**, until the flames lift off, or appear not to be touching the burners (Fig. 11-1).
4. Begin closing the air shutters, **with the tip of a screwdriver**, until the flames appear to burn while touching the burner ports (Fig. 11-2).

Note: You may then see short yellow tips on the flames. If flames are a lazy yellow, open the air shutters until the flame is blue with yellow tipping.

Note: Barbecues, in some installations, achieve a better air/gas mixture and will ignite more quickly if the valve is first turned beyond **HI LIGHT** to **LOW** for lighting.

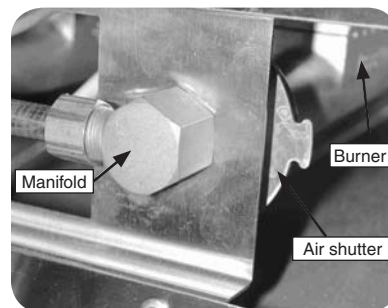
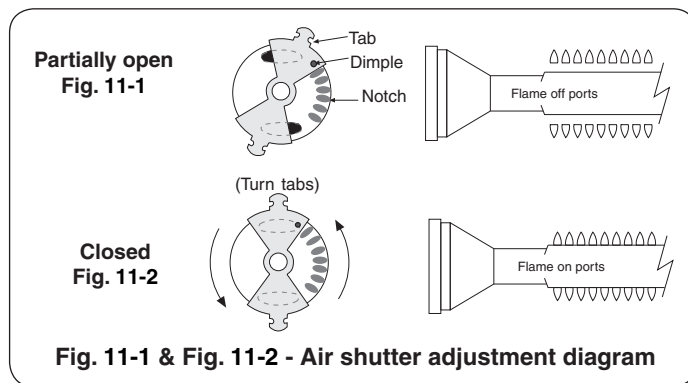

Fig. 11-3

BARBECUE SAFETY INFORMATION & MAINTENANCE

Each time you use the barbecue, make sure that:

1. The area around the barbecue is clear of flammable vapors, liquids, and substances such as gasoline, yard debris, wood, etc.
2. There is no blockage of the airflow through the vent space located below the face of the unit.
3. When using propane gas:
 - a. The special ventilation openings in the enclosure should be kept free and clear of debris (see PLANNING THE LOCATION OF THE BARBECUE).
 - b. If connected to a propane cylinder, the rubber hose attached to the regulator should be carefully inspected before each use.
 - c. The propane cylinder, regulator, and rubber hose should be installed in a location not subject to heating above 125° F (51° C).
4. The burner flames burn evenly along both sides of each burner with a steady flame, which is mostly blue. (Refer to section on AIR SHUTTER ADJUSTMENT.) A proper flame pattern will ensure safe operation and optimal performance. Adjust the air shutter as needed. If burner flames are not normal, check the orifice and burner for insects or insect nests.
5. The inline gas valve or gas cylinder valve is always shut **OFF** when the barbecue is not in use.
6. The drip collector hole is clear and unobstructed. Excessive grease deposits can result in a grease fire.
7. The barbecue is free and clear from combustible materials, gasoline, and other flammable vapors and liquids.

DRIP COLLECTION SYSTEM

The drip collector in this barbecue is part of the unit's main frame and is located below the burners. The drip collector has slots that will allow excess drippings to fall through during cooking, while separating the firebox from the drip tray. Clean the drip tray after each use.

The drip collector allows you to brush or scrape residue from the barbecue's inner liner into the drip tray. Following the manufacturer's instructions and regular cleaning of the barbecue's interior with oven cleaner, will help to prevent grease fires.

Periodically check the burners to make sure they are clear of debris. Properly adjusted burner flames burn evenly along both sides of each burner with a steady flame (mostly blue). If burner flames are not normal, check the orifice and burner for insects or insect nests. (See section on CHECKING/CONVERTING THE BURNER ORIFICES for instructions on burner removal and replacement.)

Check the burner ports at least annually for blockage by removing the burner (see orifice changing instructions) and visually inspect the gas intake tube for insects and nests. A clogged tube can lead to a fire beneath the grill.

WARNING

NEVER cover the *entire* cooking or grill surface with griddles or pans. Overheating will occur and burners will not perform properly when combustion heat is trapped below the cooking surface.

CAUTION: NEVER spray water on a hot gas unit.

The grill serial identification number is located on the underside of the drip tray handle. It is recommended that the drip tray first be removed and cleaned / emptied of its contents, then turned over to view.

LIGHTING (IGNITION) INSTRUCTIONS

Read entire instructions before lighting, and follow these instructions each time you light the grill.

ELECTRONIC LIGHTING

1. Open all lids and remove all covers from the burners you wish to light.
2. Turn all gas control knobs to their **OFF** positions.
3. Turn on the gas at its source.

Note: No matter which lighting method you use,

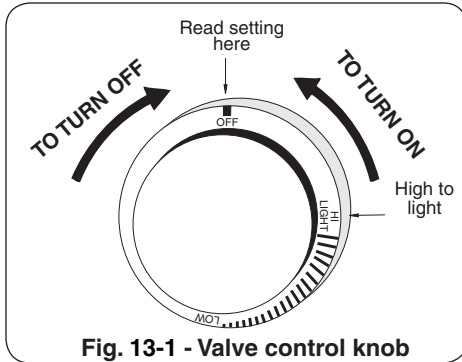

DO NOT turn on the gas to more than one burner at a time. Adjacent grill burners will cross-ignite, and gas flow may be restricted.

CAUTION: If the burners do not light within five seconds, depress the control knob and turn the knob to **OFF**. WAIT FIVE MINUTES before repeating step 4. If you smell gas, follow the instructions on the cover of this manual. If the burners still do not light after several attempts, refer to the instructions for MANUAL LIGHTING.

4. Depress the control knob for the burner to be lit and turn it to the **HI LIGHT** position, then press the ignition button. Once the burner lights, release the ignition button.
5. Repeat step 4 for each additional burner to be lit.

FOR PROPANE ONLY

Propane tanks are equipped with a safety shutdown device that may cause low or no gas pressure/flame at the burners if operating and lighting instructions are not followed exactly (See important note in the TROUBLESHOOTING section for more details.)

MANUAL LIGHTING

CAUTION: Always wait five minutes for gas to clear after any unsuccessful lighting attempt.

1. Follow steps 1 through 4 (left).
2. Insert either a burning long-barrel butane lighter, a burning long-stem match, or a burning match held by a wire extension holder (Fig. 13-2) through the cooking grids to the burner (Fig. 13-3). For backburners, hold the flame against the perforated material of the backburner. For sideburners, hold the flame against the burner.
3. While holding the match or lighter flame next to the burner, depress the appropriate burner control knob and turn it counterclockwise to the **HI LIGHT** position. When the burner lights, remove the lighter or match.

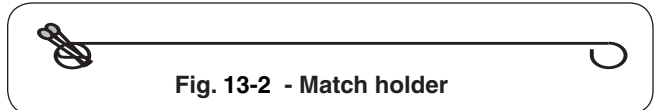

4. If the burner does not light, **IMMEDIATELY** depress the knob and turn the burner control knob to **OFF**. WAIT FIVE MINUTES before repeating steps 2 through 4 of the MANUAL LIGHTING INSTRUCTIONS.

Note: Some installations achieve a better air/gas mixture and may ignite quicker if the burner control knob is first turned beyond **HI LIGHT** to **LOW** for lighting.

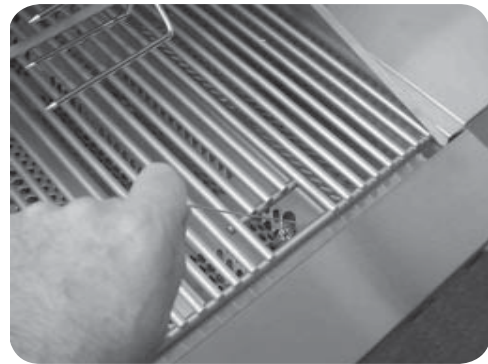

Fig. 13-3 - Manual lighting

REMEMBER: FOR SAFE MANUAL LIGHTING, PLACE A BURNING MATCH OR BUTANE LIGHTER BESIDE THE BURNER - **THEN TURN ON THE GAS** (see Fig. 13-3).

SHUTTING OFF THE GRILL

To shut off the grill, push in each valve control knob and turn it clockwise to the **OFF** position.

Always close the valve to the gas supply after each use of the grill.

ALLUMER DES INSTRUCTIONS (D'ALLUMAGE)

Lisez l'instruction entière avant que s'allumant et suivez ces instructions chaque fois vous lumière le barbecue.

ÉCLAIRAGE ÉLECTRONIQUE

1. Ouvrez tous les couvercles et enlevez toutes les couvertures des brûleurs que vous souhaitez vous allumer.
2. Arrêtez tous les boutons de commande de gaz à leurs positions.
3. Allumez le gaz à sa source.

Note: Aucune matière que la méthode d'éclairage vous emploient, n'allument pas le gaz à plus d'un brûleur à la fois. Les brûleurs adjacents de barbecue croix-mettront à feu et l'écoulement de gaz peut être restreint.

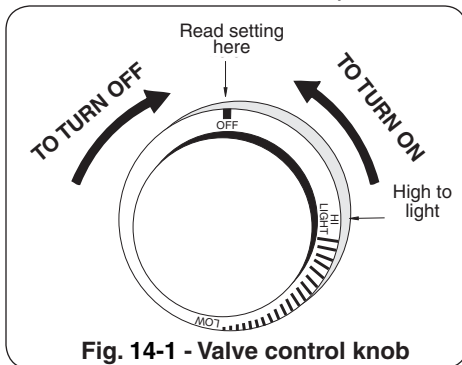

Fig. 14-1 - Valve control knob

ATTENTION: Si les brûleurs ne s'allument pas dans 5 secondes, enfoncez le bouton de commande et tournez le bouton à AU LOIN. ATTENDEZ 5 MINUTES avant de répéter l'étape 5. Si vous sentez le gaz suivez les instructions sur la couverture de ce manuel. Si les brûleurs ne s'allument toujours pas après que plusieurs tentatives, se rapportent aux instructions pour l'ÉCLAIRAGE MANUEL.

4. Enfoncez le bouton de commande pour que le brûleur soit allumé et tournez-le dans la position LÉGÈRE de HI, puis appuyez sur le bouton d'allumage. Une fois que le brûleur s'allume, libérez le bouton d'allumage.
5. Répétez l'étape 4 pour que chaque brûleur additionnel soit allumé.

POUR LE PROPANE SEULEMENT

Les réservoirs de propane sont équipés d'un dispositif d'arrêt de sûreté qui peut ne pas causer le bas ou aucun gaz pressure/flame aux brûleurs si le fonctionnement et allumer des instructions ne sont pas suivis exactement (voir la note importante dans la section de dépannage pour plus de détails.)



Fig. 14-3 - Éclairage manuel

RAPPEL-VOUS: POUR L'ÉCLAIRAGE MANUEL SÛR, PLACEZ Un ALLUMEUR BRÛLANT D'ALLUMETTE OU De BUTANE PRÈS Du BRÛLEUR - ALLUMEZ ALORS Le GAZ (voyez Fig. 14-3).

Note: Les barbecues dans quelques installations réalisent un meilleur mélange d'air/gas et mettront à feu plus rapidement si le bouton de commande de brûleur est d'abord tourné au delà de la LUMIÈRE de HI au BAS pour l'éclairage.

ÉCLAIRAGE MANUEL

ATTENTION: Attendez toujours 5 minutes le gaz à l'espace libre après que n'importe quelle tentative non réussie d'éclairage.

1. Suivez les étapes 1 à 4 (à gauche).
2. Insérez un allumeur brûlant de butane de long-baril, une allumette brûlante de long-tige, ou une allumette brûlante tenue par un support de prolongation de fil (Fig. 14-2) par les grilles à cuire au brûleur (Fig. 14-3). Pour des backburners, tenez la flamme contre le matériel perforé du brûleur arrière. Pour des sideburners, tenez la flamme contre le brûleur.
3. Tout en tenant l'allumette ou la flamme plus légère à côté du brûleur, enfoncez le bouton de commande approprié de brûleur et tournez-le dans le sens contraire des aiguilles d'une montre dans la position LÉGÈRE de HI. Quand les lumières de brûleur, enlèvent l'allumeur ou s'assortissent.

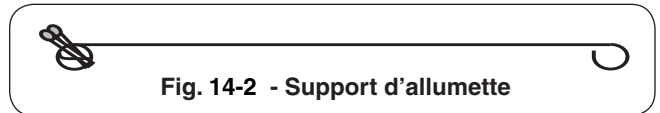

Fig. 14-2 - Support d'allumette

4. Si le brûleur ne s'allume pas, enfoncez **immédiatement** le bouton et tournez le bouton de commande de brûleur à AU LOIN. ATTENDEZ 5 MINUTES avant de répéter les étapes 2 à 4 des INSTRUCTIONS MANUELLES d'ÉCLAIRAGE.

COUPER LE GRIL

Pour couper le gril, enfoncez chaque bouton de commande de valve et tournez-le dans le sens des aiguilles d'une montre à la position de repos.

Fermez toujours la valve à l'offre de gaz après chaque utilisation du barbecue.

TROUBLESHOOTING

If you have trouble with the unit, please use this list to identify the problem. By trying one or more of the solutions to the possible cause, you should be able to solve the problem. If this list does not cover your present problem, or if you have other technical difficulties with the unit, please contact your local dealer.

PROBLEM	POSSIBLE CAUSE	CORRECTION
Ignition system failure	1) Improper air shutter adjustment	1) Adjust air shutters.
	2) Ignition wire disconnected	2) Replug wires into generator.
	3) Low gas pressure	3) Have gas company check the operating pressure at the unit.
	4) Dead battery	4) Replace battery.
Insufficient heat	1) Improper air shutter adjustment	1) Adjust air shutters.
	2) Using propane orifice for natural gas	2) Change orifices.
	3) Low gas pressure/flame (natural)	3) Have gas company check the operating pressure at the unit.
	4) Low gas pressure/flame (propane)	4) Refill propane tank, or reset propane tank safety*: Shut off all valves (including propane tank) and follow lighting instructions exactly.
Uneven heating	1) Burner ports partially blocked by debris	1) Remove burners and clean out ports.
	2) Small spiders or insects in burner	2) Inspect burners for spider webs or other debris that may block gas flow.
Burner goes out on LOW	1) Valve "Low" setting needs adjustment	1) Light burner on HIGH, immediately turn to LOW setting. Remove knob from valve and using a small flat screwdriver, slowly turn the adjustment screw in the stem, a little at a time (30° to 45°), in either direction, until the flame is approximately 1/4" in height from burner ports.

Note: *Propane tanks are equipped with a safety shutdown device that may cause low or no gas/flame at the burners if operating and lighting instructions are not followed exactly. If you suspect the propane tank safety shutoff is in effect, shut off all burner control valves and the propane tank valve. Then read and follow the LIGHTING INSTRUCTIONS exactly. Lighting instructions are located in the owner's manual. If the problem persists, continue troubleshooting, or contact your local dealer or distributor for assistance.

REPLACING THE IGNITOR BATTERY

1. Remove the ignitor cover by turning it counterclockwise.



Important: Do not attempt to pull or turn the rubber cap.



2. Remove battery for replacement. The battery is reinstalled with the negative (-) end out.



3. After properly inserting the battery, replace the ignitor cover by turning the cap clockwise.



Note: If you have accidentally removed the rubber cap, follow the instructions below to replace it.

1. Pull the rubber cap and the inner plastic sleeve apart.
 2. Carefully insert the rubber cap into the ignitor cover so it sits behind inner lip.
 3. Turn the cap over and slide the inner plastic sleeve into the cap.



ACCESSORIES

GRILL BRUSH (optional)

Purchase a Fire Magic® stainless-steel grill brush (sold separately) to keep your grill cleaner. It comes with scraper for large particles and a replaceable head with brass bristles for overall cleaning.



Fig. 16-1

Grill brush with replacement head

WARMING RACK (if equipped)

The warming rack (Fig. 16-2) is packed separately.

To install the warming rack, lift the front of the rack up slightly and insert the rack hangers into the two holes in the back of the inner oven hood. Then lower the front of the rack into a level position to lock the rack in place.

To remove the warming rack, lift up on the front of the rack until the rack hangers pull free from their supporting holes.

Note: Removing the warming rack before using the rotisserie will leave more clearance for the meat being cooked. (if applicable)



Fig. 16-2 Warming rack in place inside oven

THE COOKING GRID LIFTER

Hold the grid lifter by gripping the center section with the prongs pointing down (use an oven mitt or heavy glove if the grill is hot). Insert the notched end of the grid lifter into the cooking grid, in front of the midway point (front to back; Fig. 16-3), and central (left to right; Fig. 16-4). Twist the grill lifter (clockwise or counterclockwise) so the handle is parallel to the grill rods. This “seats” the spiked end of the grid lifter between two rods, enabling you to safely lift out the grid. Lift slowly and adjust the grid lifter, if necessary, for balance.

THE DRIP TRAY

The drip collection system allows you to brush or scrape excess dried residue from the grilling area directly into the drip tray (see PARTS LIST for drip tray location).

THE FLAVOR GRID(S)

Place each flavor grid directly over a burner or burner pair. Center each grid over the burner, oriented as shown in Fig. 16-5.

Note: This allows heat from the burners to be evenly distributed throughout the cooking area. The flavor grids heat and cool quickly, making the grill very responsive to changes in heat from the burners.



Fig. 16-3



Fig. 16-4

Placement of the grid lifter in cooking grid



Fig. 16-5

CARE & CLEANING

APPLIANCE MUST BE COMPLETELY COOL WHEN CLEANING. DO NOT SPRAY ANY CLEANER OR LIQUIDS ON THE APPLIANCE WHEN HOT.

The appliance *must* be cleaned as often as once a month (depending on use) to prevent grease build-up and other food deposits.

INTERIOR

THE **BURNER PORTS** MUST BE KEPT CLEAN TO ENSURE PROPER IGNITION AND OPERATION.

Remove the burner (see orifice changing instructions) and clean the ports and slots as required. Also inspect and clean the burner inlet for insects and nests. A clogged burner can lead to a fire in the bottom of the appliance.

The inside of the appliance may be cleaned periodically with oven cleaner if desired. Follow the oven cleaner instructions for proper use.

Be careful not to get oven cleaner on the outside surface of the appliance as it can permanently damage the finish.

EXTERIOR

Stainless steel surfaces when exposed to temperatures produced by the grilling process will change color. The stainless steel will change color from silver to brown and blue. This can be removed by using stainless steel cleaner.

Clean your appliance by first using grill cleaner to remove grease and dirt. Always wipe with the grain (See Fig. 17-1). Next, use stainless steel cleaner to restore the stainless steel color (Note: not for mirror finish). Finish by wiping your appliance down using polish wipes. **To clean any mirror finish (if applicable), use a quality brand glass cleaner only, not any of the cleaners mentioned above.**

If your appliance is installed in a seaside (salt air) or poolside (chlorine) location, it will be more susceptible to corrosion and must be maintained/cleaned more frequently. Do not store chemicals (such as chlorine or fertilizer) near your stainless steel appliance.

Due to the nature of stainless steel, surface iron oxide deposits may appear. Do not be alarmed – these deposits are removable with stainless steel cleaner through prompt and periodic maintenance. If not attended to promptly, permanent pitting may occur.

By following these recommendations, you will enjoy the beauty and convenience of your appliance for many years to come.

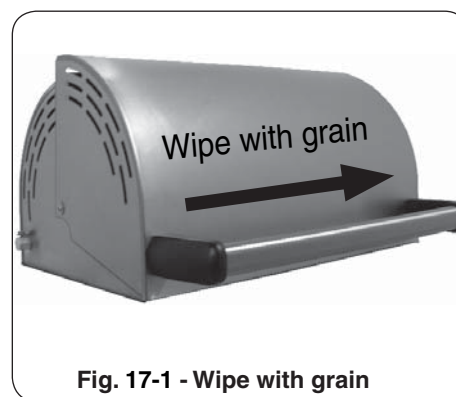

Fig. 17-1 - Wipe with grain

PROTECTING YOUR APPLIANCE FROM THE WEATHER

An optional cover will protect your appliance when not in use. (Allow to cool before covering.)

Please specify the model number and serial number of your appliance when ordering a cover.

IMPORTANT

IN THE EVENT OF A GREASE FIRE, IMMEDIATELY SHUT OFF THE MAIN GAS VALVE TO THE GRILL. KEEP THE LID OPEN AND ALLOW THE FIRE TO EXTINGUISH ITSELF. A THOROUGH INSPECTION BY A TRAINED SERVICE TECHNICIAN SHOULD BE CONDUCTED BEFORE FUTURE USE OF YOUR GRILL. THE SERVICE TECHNICIAN WILL CHECK THE SYSTEM FOR GAS LEAKS AND WILL CHECK ALL ELECTRICAL WIRING FOR DAMAGE. ALL GAS LEAKS AND WIRING MUST BE REPAIRED PRIOR TO FUTURE USE.

WARRANTY

PETERSON FIRE MAGIC GRILLS AND ACCESSORIES LIMITED WARRANTY

Robert H. Peterson Co. ("RHP") warrants your Fire Magic® grill to be free from defects in material and workmanship.

Fire Magic® cast stainless-steel burners, stainless-steel rod cooking grids, and stainless-steel housings are warranted for as long as you own your Fire Magic® grill -- **LIFETIME**. (Except as noted below.)

Fire Magic Choice stainless steel tubular burners are warranted for **TWENTY (20) YEARS**.

Fire Magic® cast brass burners, brass valves, inner liners, manifold assemblies, and backburner assemblies (except ignition parts) are warranted for **FIFTEEN (15) YEARS**.

Fire Magic® Electric Grills, including stainless steel grid, and housings are warranted for **TEN (10) YEARS**.

Fire Magic® Infra-red burners, flavor grids, Charcoal stainless steel grills, and Smokers are warranted for **FIVE (5) YEARS**; except for the charcoal pan, charcoal grid, wood pellet screen, thermometer, and ash tray; which are warranted for **ONE (1) YEAR**.

Fire Magic® sideburners and all other Fire Magic® grill components (except ignition and electronic parts) are warranted for **THREE (3) YEARS**.

Fire Magic® ignition systems (excluding batteries), electronic components (including lights and thermometers), and grill accessories are warranted for **ONE (1) YEAR**.

A COPY OF YOUR SALES SLIP FOR PROOF OF PURCHASE IS REQUIRED

This warranty applies to the original purchaser for products which are installed in the United States or Canada and which are operated and maintained as intended for single family residential usage. This warranty is valid only with proof of purchase, shall commence on the date of purchase, and shall terminate (both as to original and any replacement products) on the anniversary date of the original purchase of the product stated on the above schedules.

This warranty covers defects in material and workmanship. This warranty **does not** cover parts which become defective as a result of negligence, misuse, use not in compliance with the Owner's Manual/Installation Instructions, accidental damage, improper handling, improper storage, improper installation, lack of required routine maintenance (as specified in the Owner's Manual/Installation Instructions), electrical damage, local gas impurities or failure to protect against combustibles. Product must be installed (and gas must be connected) as specified in the Owner's Manual/Installation Instructions by a **qualified professional installer**. Modifications to products which are not specifically authorized will void this warranty. Accessories, parts, valves, remotes, etc. when used must be Peterson products or this warranty is void. Warrantied items will be repaired or replaced at Peterson's sole discretion. This warranty **does not** apply to rust, corrosion, oxidation, or discoloration unless the affected part becomes inoperable.

This warranty **does not** cover labor or labor related charges, except as provided by separate specific written programs from the Peterson Co. All repair work must be performed by a qualified professional service person and requires prior approval of Peterson.

Peterson may require the defective product or part to be returned to the factory to determine the cause of failure. Peterson will pay freight charges if the product or part is determined to be defective. This warranty does not cover breakage in shipment from our (Independent) distributor to its customer if the damage is determined to have occurred during that shipment.

This warranty specifically excludes liability for **indirect, incidental, or consequential** damages. Some states and provinces do not allow the exclusion or limitation of incidental or consequential damages, so the above exclusion may not apply to you. This warranty gives you specified legal rights, and you may have other rights that vary from state to state or province.

For additional information regarding this warranty, or to place a warranty claim, contact the R. H. Peterson dealer where the product was purchased.

**TO REGISTER YOUR PRODUCT ONLINE GO TO: WWW.RHPETERSON.COM,
AND CLICK ON PRODUCT REGISTRATION. THANK YOU FOR YOUR PURCHASE.**

Quality Check			Date: _____	
Burner Orifices	Nat.	L.P.	Leak Test: _____	Model#: _____
Main:	_____	_____	Burn Test: _____	Serial#: _____
Other:	_____	_____	Gas Type: <u>Nat. / L.P.</u>	Air Shutter: _____
				Inspector: _____