



LED strip

BLUETOOTH RGB



16 MILLION
COLORS



User manual / Gebruiksaanwijzing
Handbuch / Manuel d'utilisation

Index

English	3
Nederlands	12
Deutsch	21
Français	30

Table of contents

Product feature	4
Product parameter	4
Product dimension	4
What's in the package	5
Installation diagram	6
Add device	6
Group control	8
Controller box	9
Remote control	10

Product feature

Bluetooth version: mesh 5.0

Connection range: max. 15 meters

Group control: connect up to 200 devices at the same time

Product parameter

Span: DC-5-24V

Max current: 3A

Max power: 72

Humid: 80% RH

Working environment: indoors

Working temperature: -20°C - 45°C (-4°F - 113°F)

Product dimension

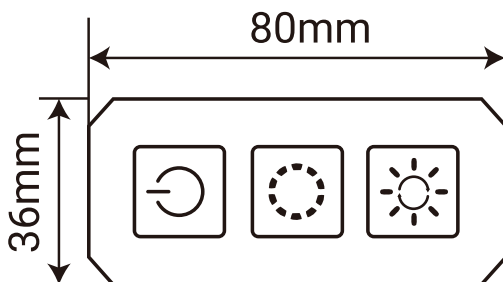

What's in the package

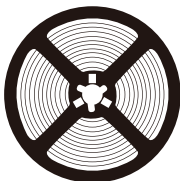

Light strip

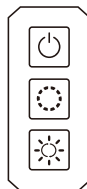

Remote control

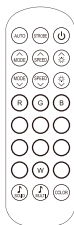

24 keys on remote

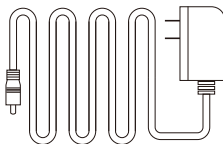

Charger



Instruction manual



3M adhesive tape

Installation diagram

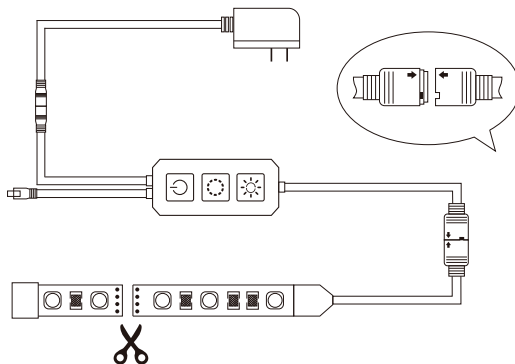

Add device

(1) Download: Lideka Home app



(2) Add device:

- Switch on the LED strip and open the Lideka Home app
- Make sure GPS and Bluetooth are turned on
- Press "+" to add

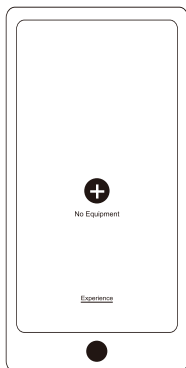

Touch '+'

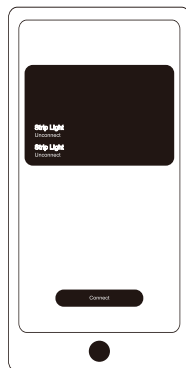

Search device

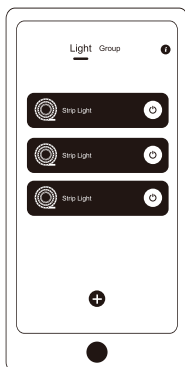

Device found

Group control

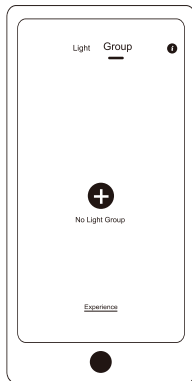

Touch '+'

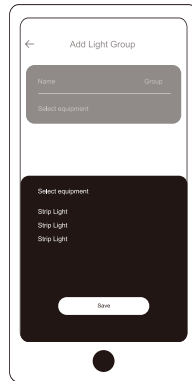

Search device

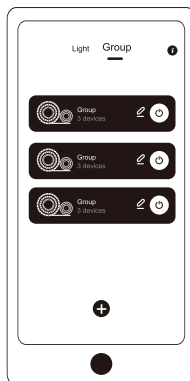

Name group

Controller box

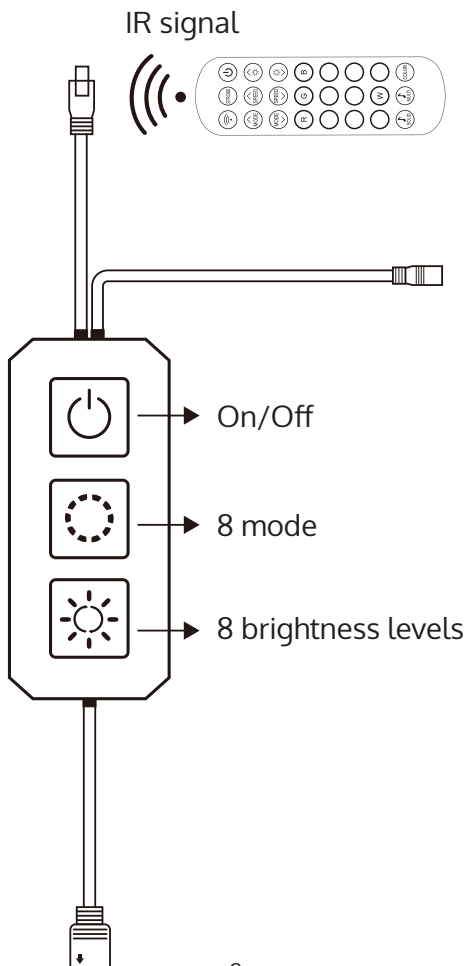

Remote control

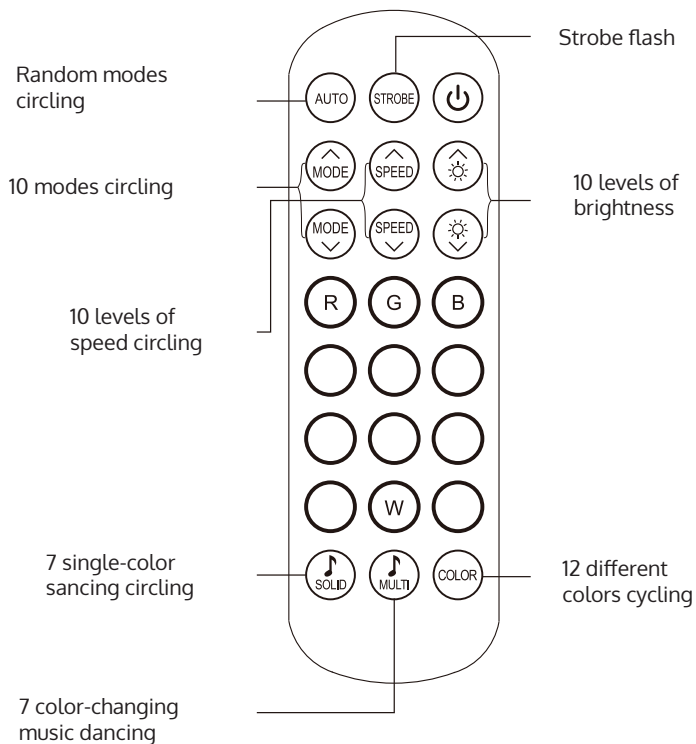

For corner setup bend the strip and reinforce via clips; (NOTICE: avoid bending on LED beads.)

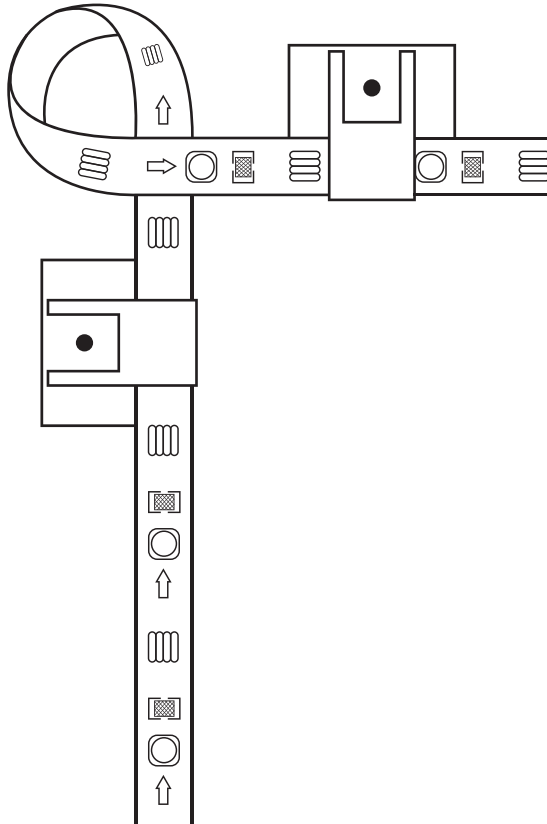

Inhoudsopgave

Producteigenschap	13
Productparameter	13
Product dimensie	13
Wat zit er in de verpakking	14
Installatie diagram	15
Voeg toestel toe	15
Groeps gebruik	17
Controller box	18
Afstandsbediening	19

Producteigenschap

Bluetooth-versie: mesh 5.0

Aansluitbereik: max. 15 meter

Groepscontrole: sluit maximaal 200 apparaten tegelijk aan

Productparameter

spanning: DC-5-24V

max stroom: 3A

max vermogen: 72W

vochtig: 80% RH

werkomgeving: binnen

werktemperatuur: -20°C - 45°C (-4°F - 113°F)

Product dimensie

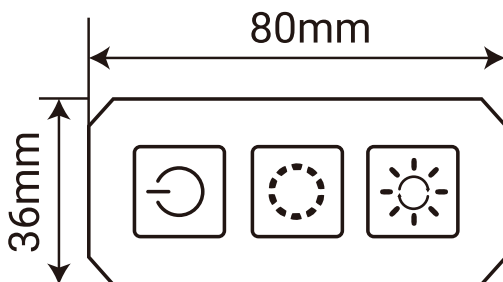

Wat zit er in de verpakking

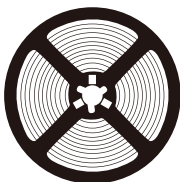

Striplight

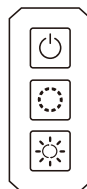

Afstandsbediening



24 toetsen op
afstandsbediening

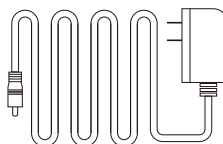

Oplader



Handleiding



3M plakbare plakband

Installatie diagram

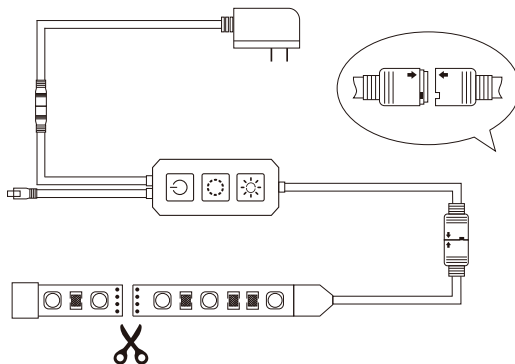

Voeg toestel toe

(1) Download: Lideka Home app



(2) Add device:

- Zet de Led-strip aan en open de Lideka Home app
- Zorg dat gps en bluetooth ingeschakeld is
- Druk op '+' om toe te voegen

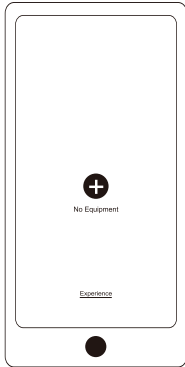

Druk '+'

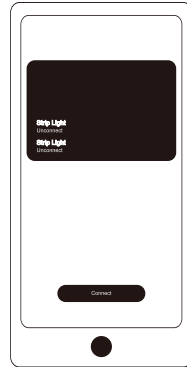

Zoek apparaat

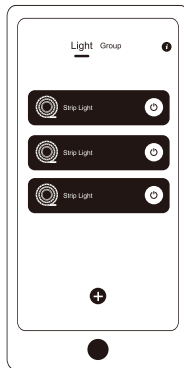

Device found

Groeps gebruik

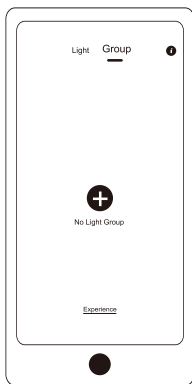

Druk '+'

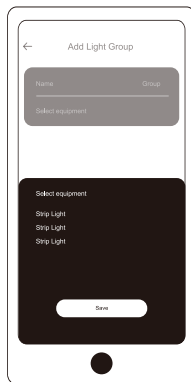

Zoek apparaat

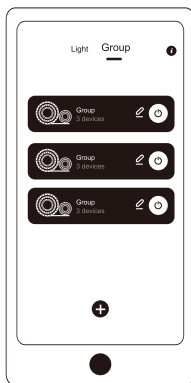

Groep naam

Controller box

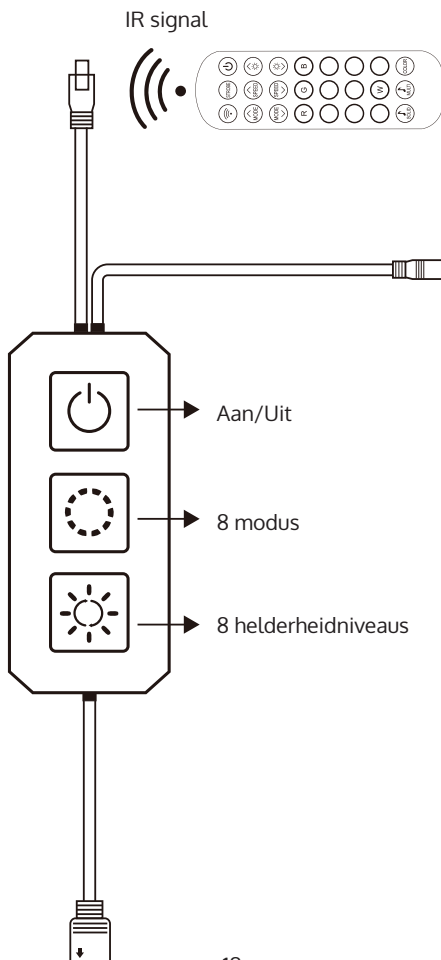

Afstandsbediening

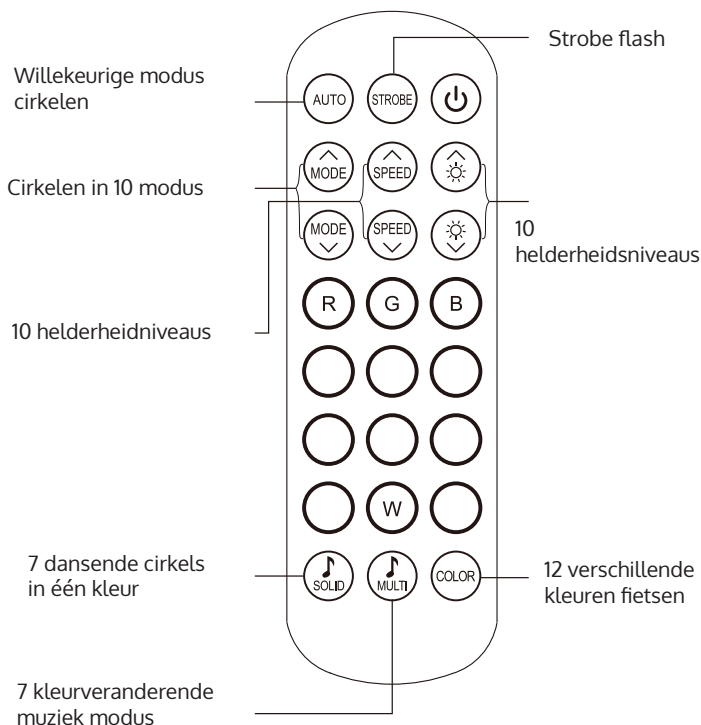

Voor een hoekopstelling, buig de strip zoals hieronder weergegeven, en versterk de strip met de bijgeleverde klipjes. (WAARSCHUWING: Vermijd het buigen op Led-kralen)

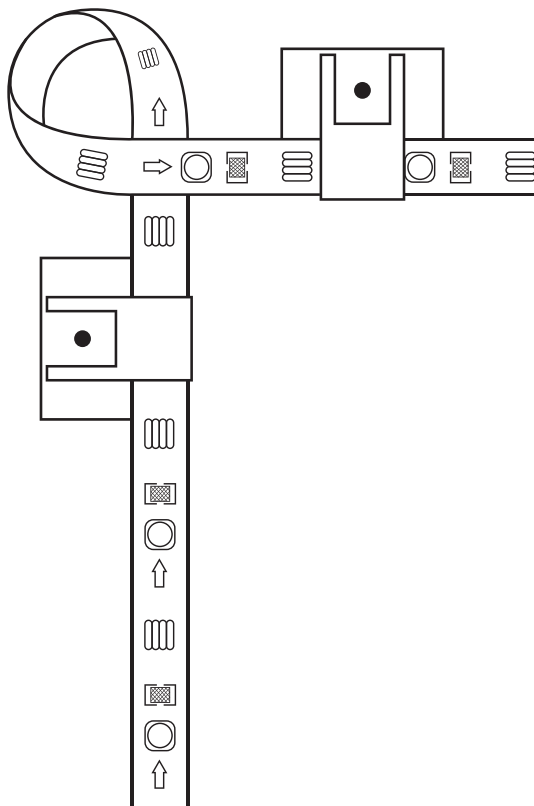

Inhaltsverzeichnis

Produkteigenschaften	22
Produktparameter	22
Produktabmessung	22
Was gehört zum Lieferumfang	23
Installationsplan	24
Gerät hinzufügen	24
Gruppensteuerung	26
Steuerbox	27
Fernbedienung	28

Produkteigenschaften

Bluetooth-Version: Mesh 5.0

Übertragungreichweite: max. 15 Meter

Gruppensteuerung: Anschluss von bis zu 200 Geräten zur gleichen Zeit

Produktparameter

Spanne: DC-5-24V

Maximale Stromstärke: 3 A

Maximale Leistung: 72 W

Luftfeuchtigkeit: 80% RH

Arbeitsumgebung: Innenraum

Betriebstemperatur: - 20°C - 45°C (-4°F - 113°F)

Produktabmessung

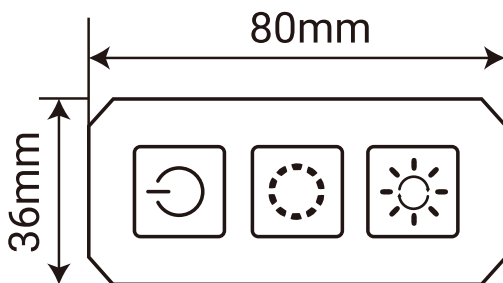

Was gehört zum Lieferumfang

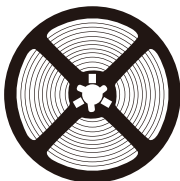

Lichtleiste

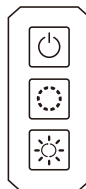

Fernbedienung



24 Tasten-Fernbedienung

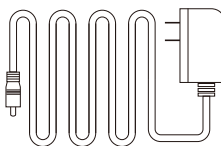

Ladegerät



Bedienungsanleitung



3M-Klebeband

Installationsplan

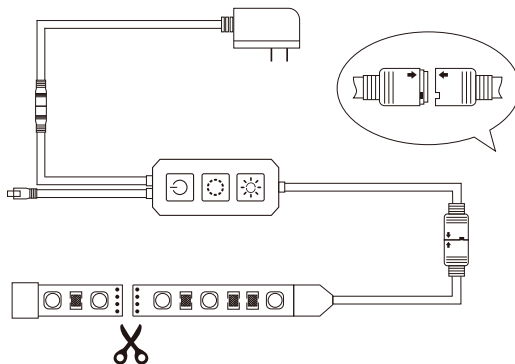

Gerät hinzufügen

(1) Download: Lideka Home app



A

SCAN ME

(2) Gerät hinzufügen:

- Schalten Sie die LED-Leiste ein und öffnen Sie die Lideka Home App
- Stellen Sie sicher, dass GPS und Bluetooth eingeschaltet sind
- Drücken Sie „+“ zum Hinzuzufügen

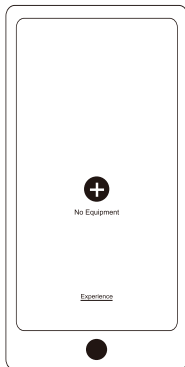

Berühren Sie '+'

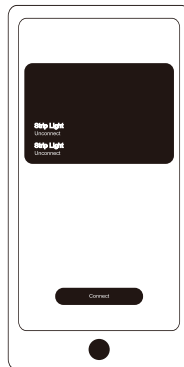

Geräte suchen

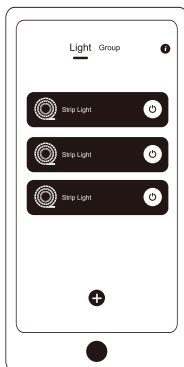

Device found

Gruppensteuerung

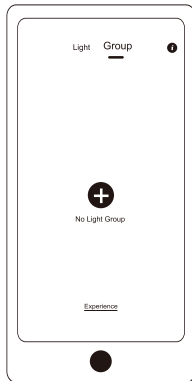

Berühren Sie '+'

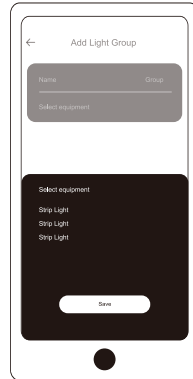

Geräte suchen

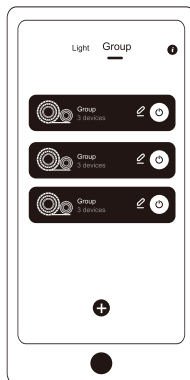

Namensgruppe

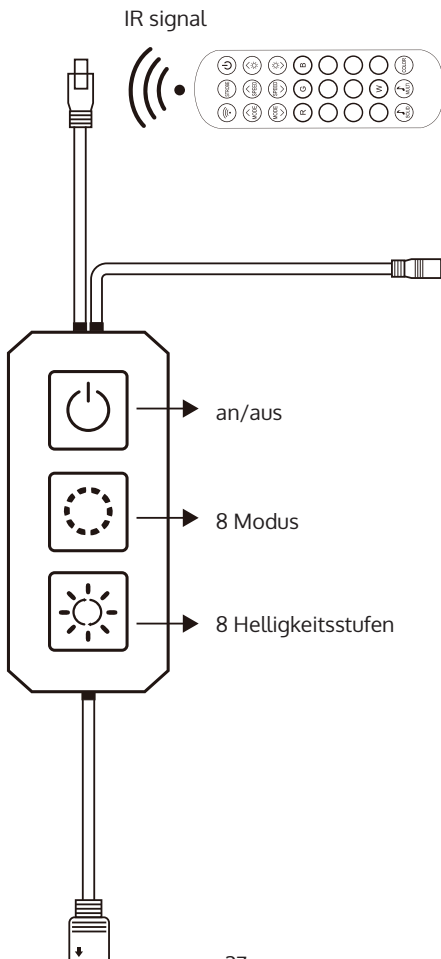

Fernbedienung

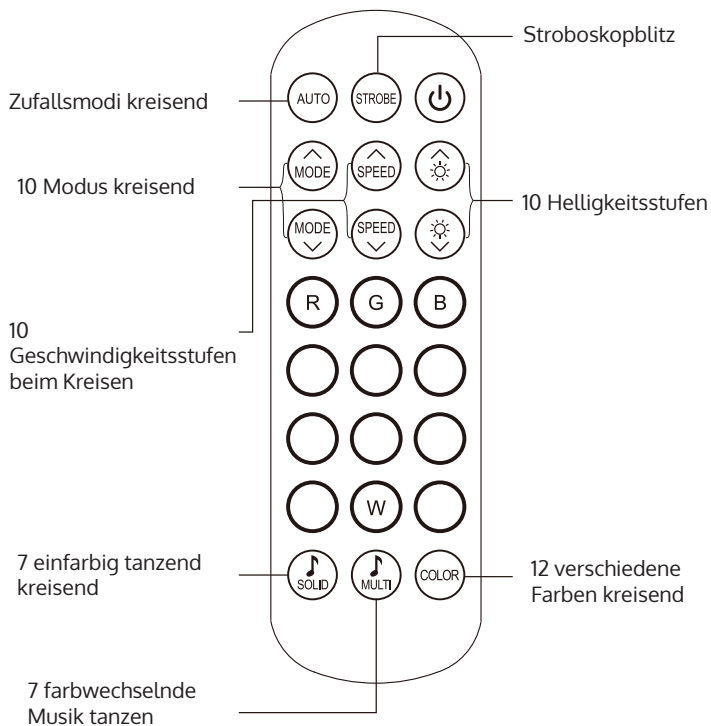

Bei Eckaufstellung den Streifen biegen und mit Clips verstärken;
(HINWEIS: LED-Perlen biegen vermeiden)

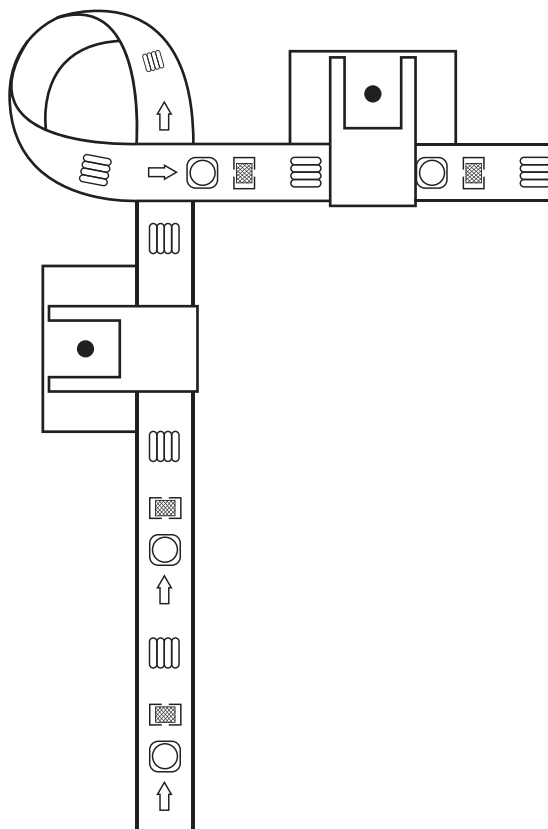

Table des matières

Caractéristiques du produit	31
Paramètre du produit	31
Dimension du produit	31
Contenu de la boîte	32
Schéma d'installation	33
Ajouter un périphérique	33
Utilisation en mode groupe	35
Boîtier de commande	36
Télécommande	37

Caractéristiques du produit

version Bluetooth : bande 5.0

portée de connexion : jusqu'à 15 mètres

commande centralisée : connectez jusqu'à 200 appareils en même temps

Paramètre du produit

tension : DC-5-24V

intensité maximale : 3A

puissance maximale : 72W

taux d'humidité : 80% HR

environnement de travail : intérieur

température de fonctionnement : -20°C - 45°C (-4°F - 113°F)

Dimension du produit

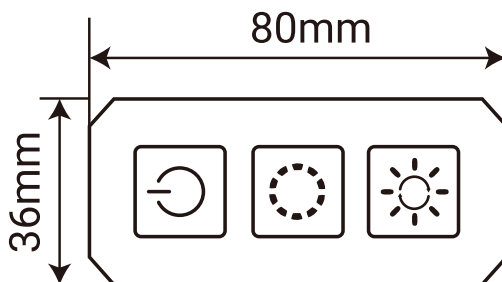

Contenu de la boîte

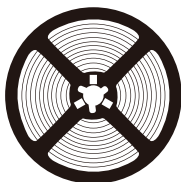

Bande lumineuse

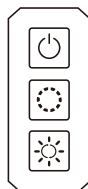

Télécommande



24 touches sur la télécommande

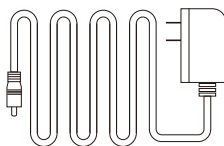

Chargeur



Manuel



Ruban adhésif 3M

Schéma d'installation

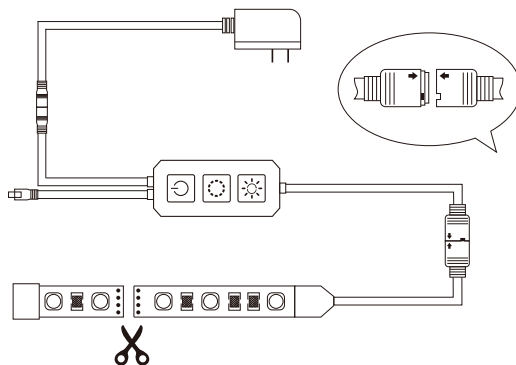

Ajuter un périphérique

(1) Télécharger : appli Lideka Home



(2) Ajouter un périphérique :

- Allumez la bande LED et ouvrez l'application Liddeka Home
- Assurez-vous que le système GPS et le Bluetooth sont activés
- Appuyez sur « + » pour ajouter

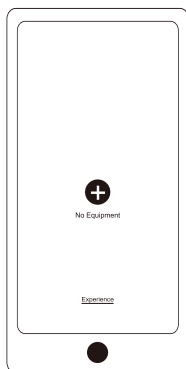

Appuyez sur « + ».

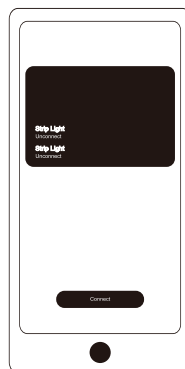

Dispositif de recherche

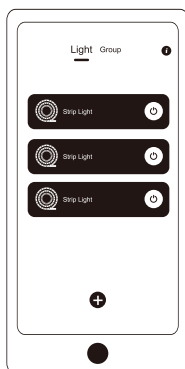

Device found

Utilisation en mode groupe

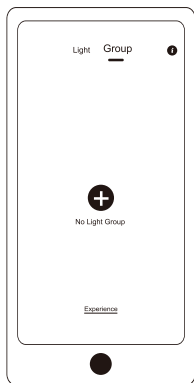

Appuyez sur « + ».

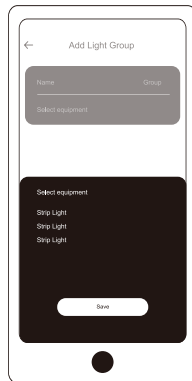

Dispositif de recherche

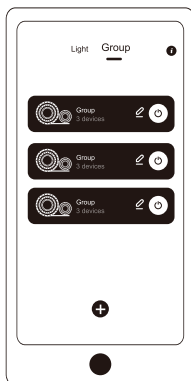

Namensgruppe

Boîtier de commande

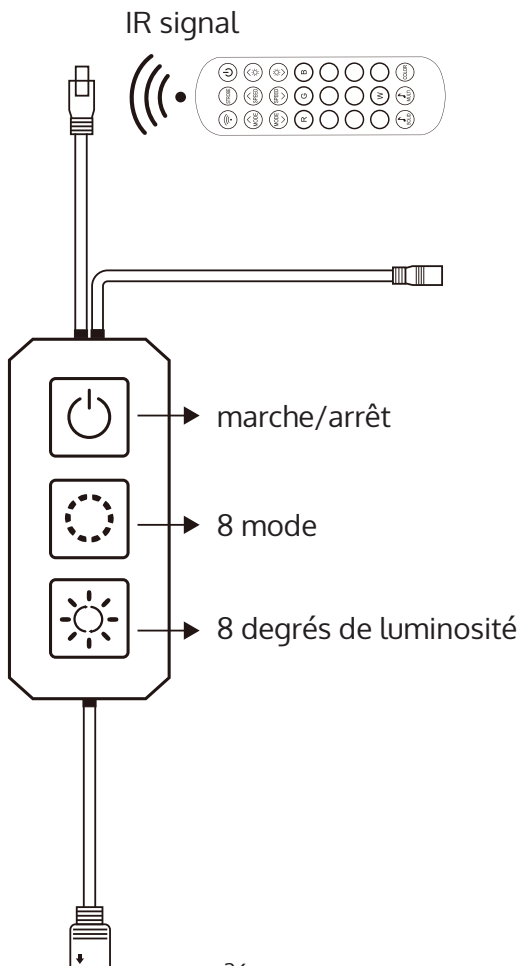

Télécommande

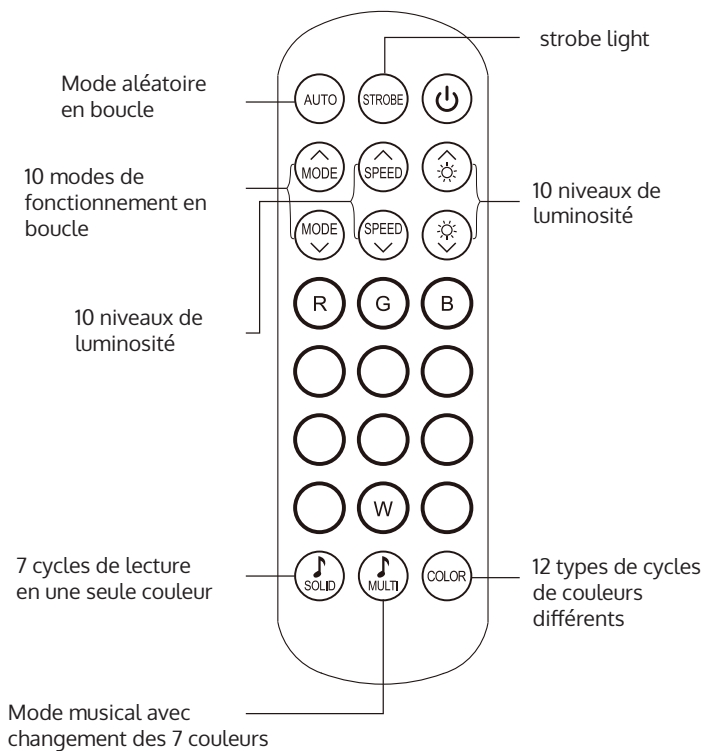

Pour une installation en angle, pliez la bande comme indiqué ci-dessous, et renforcez-la à l'aide des crochets prévus à cet effet (ATTENTION : éviter de tordre les Leds).

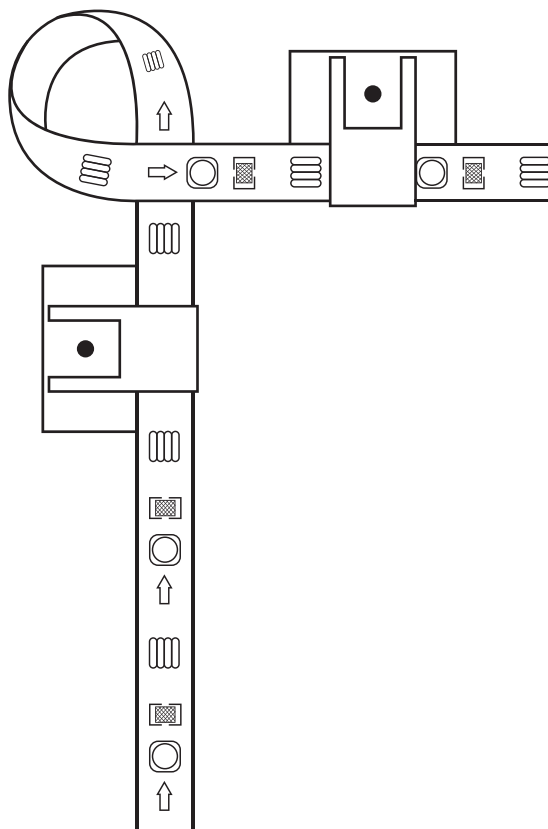



SOFT RAYS
OF LIGHT



ENVIRONMENTALLY
FRIENDLY



LOW
NOISE



LOW
HEAT



ENERGY
SAVING



ULTRA VIOLET
RADIATION

LED strip

BLUETOOTH RGB



LIDEKA
— LED —