

TM

AlfrescoTM

Open Air Culinary Systems



URS-1 Refrigerator Care and Use Manual

SERIAL NUMBERS: 06-10679 TO 08-16900

**PLEASE READ THIS MANUAL BEFORE USING YOUR APPLIANCE.
KEEP THIS MANUAL IN A SAFE PLACE FOR FUTURE REFERENCE.**

ASSEMBLER / INSTALLER

Leave these instructions with the customer

CONSUMER/USER

Read these instructions and keep them in a safe place for future reference

NOTE TO CUSTOMER:

This appliance was carefully packed and thoroughly inspected before leaving our factory. Responsibility for its safe delivery was assumed by the carrier upon acceptance of the shipment. As directed on the packing carton, claims for loss or damage sustained in transit must be made to the carrier as follows:

A) Exterior Damage: Make a thorough damage notation on your delivery receipt and have driver acknowledge by signature and date. Send a written request asking for an inspection report from the carrier. Include the name of the carrier representative and the date the inspection was requested. Retain the inspection report and receipt for filing of a claim.

B) Concealed Damage: This must be reported to carrier within fifteen days of receipt. Obtain inspection report from the carrier. Retain inspection report for filing of a claim. **DO NOT RETURN DAMAGED MERCHANDISE TO MANUFACTURER OR DEALER - FILE CLAIM WITH THE CARRIER.**

WARNING DO NOT SPLASH OR SPRAY WATER FROM A HOSE ONTO THE REFRIGERATOR. DOING SO MAY CAUSE AN ELECTRICAL SHOCK, INJURY OR DEATH.

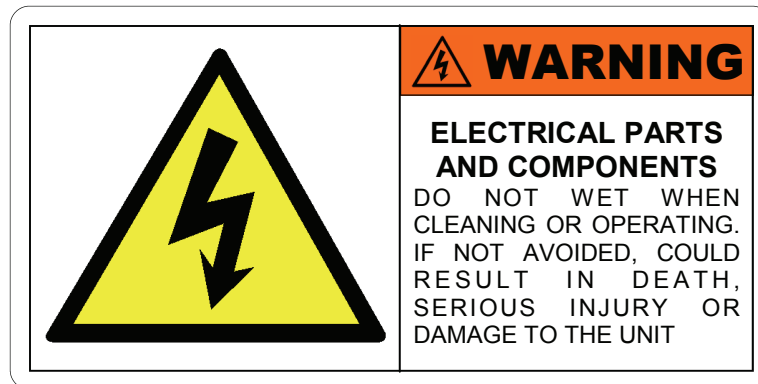

WARNING

CONTENTS UNDER PRESSURE.



WARNING

FOR OUTDOOR USE ONLY. THIS APPLIANCE IS NOT INTENDED TO BE INSTALLED IN OR ON RECREATIONAL VEHICLES AND/OR BOATS.

WARNING

IMPORTANT ELECTRICAL INSTRUCTIONS: THE REFRIGERATOR IS EQUIPPED WITH A THREE-PRONGED (GROUNDING) PLUG FOR YOUR PROTECTION AGAINST SHOCK HAZARD AND SHOULD BE PLUGGED DIRECTLY INTO A PROPERLY GROUNDED THREE-PRONGED RECEPTACLE. DO NOT CUT OR REMOVE THE GROUNDING PRONG FROM THIS PLUG. KEEP CORD AWAY FROM HEATED SURFACES. DO NOT USE AN EXTENSION CORD.

URS-1 CONTROL SETTINGS AND TEMPERATURE ADJUSTMENT:

OPERATION:

Your *ALFRESCO* refrigerator features a constant cut-in thermostat to avoid coil freezing. It operates by lowering the cabinet temperature to your desired setting (1 through 7) but always provides a defrost to the unit as it cycles ON and OFF during operation.

CONTROLS AND LOCATION:

**ON / OFF
MAIN POWER
SWITCH**

THERMOSTAT CONTROL

LIGHT SWITCH

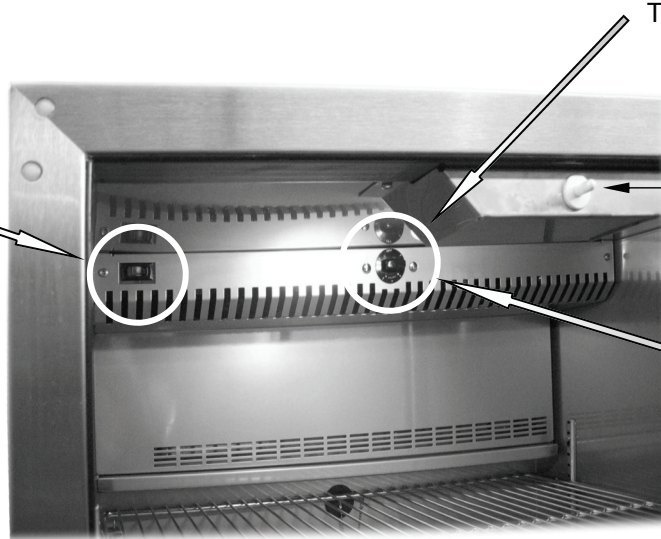

IMPORTANT NOTE:

This refrigerator is equipped with a time delay to protect the compressor. When the unit is powered on, the compressor will not run for approximately ten minutes, this is normal. The refrigeration cycle will then start but it may be a further five to ten minutes before cold air will be perceived inside the unit.

**THERMOSTAT SET POSITION: READ AT
BOTTOM OF DIAL. SETTING SHOWN #4**

Switch the unit ON using the main ON/OFF power switch. Immediately after the unit is switched on the cabinet light and inside evaporator fans will start operating. Turn the thermostat knob clockwise from the OFF position to the desired temperature setting.

ALFRESCO™ recommends starting the unit at number 4 for optimal operation, and adjusting up or down to your preference once the units' cabinet temperature has stabilized after 24 hours of operation.

ADJUSTMENTS ITEMS TO REMEMBER:

- ▶ **FOR NORMAL OPERATION SET THE UNIT TO NUMBER 4**
- ▶ **DO NOT CHANGE THE TEMPERATURE SETTING MORE THAN 1 NUMBER AT A TIME.**
- ▶ **ALLOW 24 HOURS FOR THE REFRIGERATOR TO REACH A NEW TEMPERATURE SETTING.**
- ▶ **THE MOTOR WILL START AND STOP OFTEN. THIS IS NORMAL OPERATION.**
- ▶ **KEEP YOUR REFRIGERATOR LEVELED.**

USE TIPS & ENERGY SAVING IDEAS

CLEANING:

Exercise caution when sweeping, vacuuming or mopping near the front of the unit.

For normal cleaning, mix 2 tablespoons of baking soda with 1 quart of warm water or use a mild soap. Do not use harsh cleaners or abrasives. Do not splash or spray water onto or under the refrigerator.

TIPS FOR ENERGY SAVING:

Your *ALFRESCO*™ refrigerator is designed with the latest technology to be highly energy efficient. However, following a few simple tips can help save even more energy.

- Limit how often the door is opened.
- Close the door as soon as possible after opening.
- Don't put hot foods into the unit.
- During prolonged periods of non- use, set the temperature to a higher setting or switch the unit off.
- Keep door and drawer gaskets clean to ensure a proper seal.

CARE AND MAINTENANCE OF YOUR REFRIGERATOR:

Stainless Steel is widely used for kitchen equipment because of its strength, its ability to resist corrosion and its ease of cleaning. In fact, stainless steel ranks alongside glass and new china in terms of "ease of cleaning" and in percentage removal of bacteria during washing. As a result of these virtues, the metal is often taken for granted and it is assumed that no problems will arise during its usage. However, some care is required to ensure that the stainless steel can live up to this reputation.

DAY TO DAY CARE

To maintain the original appearance of your *ALFRESCO* Refrigerator, a regular cleaning routine should be carried out using the following guidelines:

After use, wipe the unit with a soft, damp, soapy cloth and rinse with clean water, preferably warm/hot water. This should remove most substances encountered during use.

For more tenacious deposits, including oil, grease and water-borne deposits, use a multipurpose cream cleanser and apply with a soft damp cloth. Rinse with fresh water.

Harsh abrasives and scouring materials should not be used for cleaning stainless steel as they will leave scratch marks in the surface and damage the appearance. Likewise do not use wire brushes, scrapers or contaminated scouring pads.

If the preceding guidelines are adhered to, your *ALFRESCO* Stainless Steel Refrigerator should offer excellent life and should live up to its reputation of being "stainless".

Neglect of this practice, however, can lead to deterioration of the surface and, in some extreme cases, corrosion of the steel itself. The two most common types of corrosion that may be encountered, particularly on stainless steel, are rust marks and pitting of the surface.

RUST BROWN MARKS

When this type of staining occurs it is unlikely that rusting of the stainless steel itself caused the marks. Similar marks can be found with both porcelain and plastic sinks. The rust marks are more likely the result of small particles of "ordinary-steel" which have become attached to the surface and subsequently rusted in the damp environment. The most common source of such particles is from "wire wool" scouring pads, but may also occur from carbon steel utensils and old cast iron water supply pipes.

These brown marks are only superficial stains, which will not harm the unit; they should be removable using a soft damp cloth and multi-purpose cream cleanser. Occasionally, it may be necessary to resort to a proprietary stainless steel cleanser, to return the surface of the unit to its original condition.

PITTING

Another form of corrosion, which occasionally occurs in stainless steel, is pitting of the surface. The reason for this corrosive attack can usually be attributed to certain household products, for example:

BLEACHES

Most common domestic bleaches & sterilizing solutions contain chlorine in the form of sodium hypochlorite. If used in concentrated form, bleaches can attack the stainless steel, causing pitting of the surface. They should always be used to the strengths prescribed by the manufacturer and should be thoroughly rinsed off with clean water immediately after use.

FOODSTUFFS

In general, stainless steel is fully resistant to all foodstuffs in common use. Only in isolated cases, such as when concentrated salt and vinegar mixtures are allowed to remain in contact with the steel for a long period, can any surface marking result.

REPLACING THE INTERIOR LIGHT

Your *ALFRESCO* refrigerator is equipped with an interior light, it is a standard 40 Watt / 120 volts AC refrigerator bulb. (It is also known as T6.5 intermediate base appliance bulb). To replace, unplug the unit, remove the burned-out bulb located behind the light switch box at the interior top and install the new one. Plug the unit back into its electrical outlet to restore normal operation.

LIGHT BULB LOCATION:

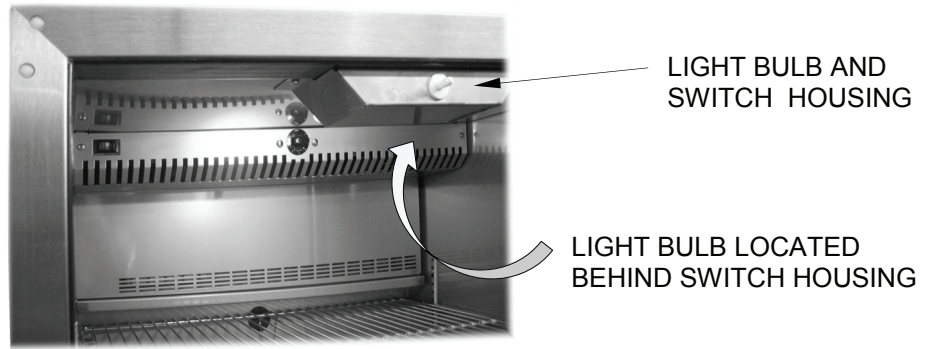

TROUBLESHOOTING

BEFORE CALLING FOR SERVICE

If the unit does not function properly use the following checklist before contacting your dealer for service. You may save the cost of a service call and the inconvenience of being without your refrigerator.

REFRIGERATOR NOT COOLING ENOUGH

Lower the temperature of the cabinet by turning thermostat clockwise to a higher cooling number.

NOISY OPERATION

This is usually caused by the unit not being level. Reposition the refrigerator to see if the noise can be eliminated.

MOISTURE ON OR IN UNIT

Warm moist air will condense on cold surfaces. Condensation inside the unit can be caused by too frequent or prolonged opening of the doors. Moisture can also be caused by the thermostat being set too cold. Check the temperature of the unit. Try adjusting to a slightly higher temperature to see if the problem can be eliminated. Minimize door openings and verify that the door gasket is sealing properly around the perimeter.

APPLIANCE RUNS TOO LONG

Running time will change with outside temperature, number of times and length-of-time the doors are open, etc. This is normal in hot or humid weather and is not detrimental to the operation of the unit

LOCATING AND INSTALLING YOUR REFRIGERATOR

NEVER SPLASH OR SPRAY WATER FROM A HOSE DIRECTLY ON THE REFRIGERATOR. DO NOT LOCATE THE UNIT WHERE IT WILL BE SUBJECT TO DIRECT SPRINKLER SPRAY. EXCESSIVE WATER CONTACT MAY RESULT IN ELECTRICAL SHOCK, SERIOUS INJURY OR DEATH.

SELECT LOCATION

The proper location will ensure peak performance of your refrigerator. Choose a location where the unit will be out of direct sunlight and away from heat sources. Your *ALFRESCO* refrigerator is designed to be operated in a properly ventilated area with an ambient temperature of not less than 30°F, nor more than 120°F.

Your *ALFRESCO* refrigerator requires ventilation from the bottom front of the unit. For a cart-mounted (Optional wheel kit) model, keep the area directly in front and behind the unit clear of obstructions. For a built-in unit, make sure the back and bottom of the unit have at least 2 inches of clearance to the cabinet, and that the unit can be easily removed from the cabinet for servicing.

ELECTRICAL SERVICE

All ETL listed refrigerators are equipped with a three pronged plug. Use only the electrical cord supplied with the unit, which must be plugged directly into a properly grounded 3-prong outlet, preferably a GFCI circuit, in accordance with the National Electrical Code and applicable local codes and ordinances. The third prong (grounding prong) **SHOULD NOT**, under any circumstances, be cut or removed. Do not use an extension cord with this unit.

KEG COOLER APPLICATION:

Your *ALFRESCO* refrigerator has been designed with enough interior volume to hold a standard US full size 15 gallon beer keg. In addition, the refrigerator allows the installation of a beer faucet and support arm that will allow you to serve "Beer-on-Tap".

This optional equipment permits you to have an under counter Keg Tap system as well as a movable unit with the optional caster kit. The Keg kit is very easy to install by following the next steps:

KEG KIT INSTALLATION & COMPONENTS:

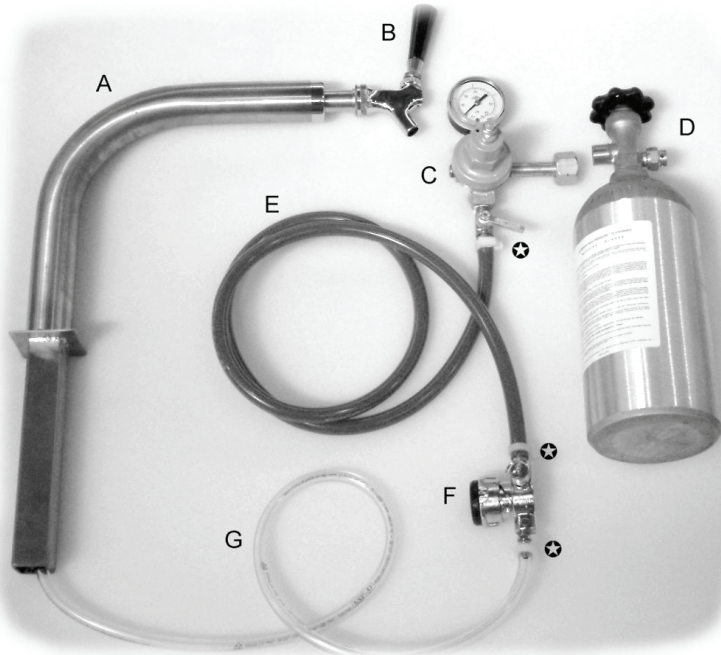

KEG KIT COMPONENTS:

- A - Support Arm.
- B - Beer Faucet ["TAP"].
- C - Single Gauge Pressure Regulator with connector and shut-off ball valve.
- D - Aluminum 2.5 Lbs CO₂ Bottle.
- E - CO₂ Pressure line (5/16" ID / BLUE color line)
- F - Sanitary Key ["SANKEY"] Standard US - low profile.
- G - Beer Line (3/16" ID / CLEAR color line).

☼ Tubing Clamps.

KEG KIT INSTALLATION:

1. On the back top section of your refrigerator there is an opening provided for the faucet support arm (see pictures 1 & 2).
2. Remove the cap as shown on picture 2 by lifting the cap straight out, exposing the opening.
3. Save the cap for future use.



Picture 1

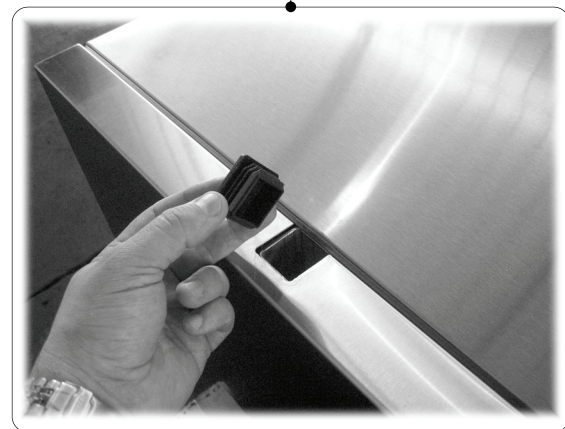

Picture 2

KEG KIT INSTALLATION (cont.)

3. Remove the beer line access hole plug located on the inside of the refrigerator, just below evaporator. (See pictures 3 & 4)
4. Insert the beer line (3/16" ID / clear color tubing) from the top of the refrigerator and allow it to drop to the inside of the refrigerated compartment.

NOTE: The beer line travels through the back section of the unit into the refrigerated compartment by following the faucet arm support structure located behind the refrigerator's back cover. (See pictures 5)

There is no need to remove the back cover of the refrigerator for this procedure.

5. Once the beer line has been inserted all the way to the refrigerated section, insert the support arm into the top opening.
6. Install the pressure regulator to the CO₂ bottle and tighten securely using a wrench in order to avoid CO₂ leakage.
7. Close the ball valve in the regulator and open the CO₂ bottle valve.
8. Adjust the regulator to a pressure between 8 ~ 10 PSI using the regulator set screw.

NOTE: More than 10 PSI of pressure will cause the beer to foam up at the tap, maintain the pressure between 8 ~ 10 PSI for optimum performance.

9. Connect the CO₂ line (5/16" ID / Blue color tubing) to the regulator and Sanitary Key [SANKEY] and install the hose clamps provided in order to secure the tubing to the hose barbed fittings.
10. Install the Sanitary Key [SANKEY] on the beer keg and connect the beer line from the faucet arm to the SANKEY. Secure the tubing with the clamps provided.
11. Open the CO₂ regulator ball valve slowly to pressurize the keg.
12. Open the TAP faucet slowly to allow the beer to flow through the system.
13. Locate the Keg and CO₂ bottle inside the refrigerator.

NOTE: Maintain beer between 34°F and 38°F for proper flow and foam. If beer is over 38°F it will foam out easily.

14. **ENJOY!**

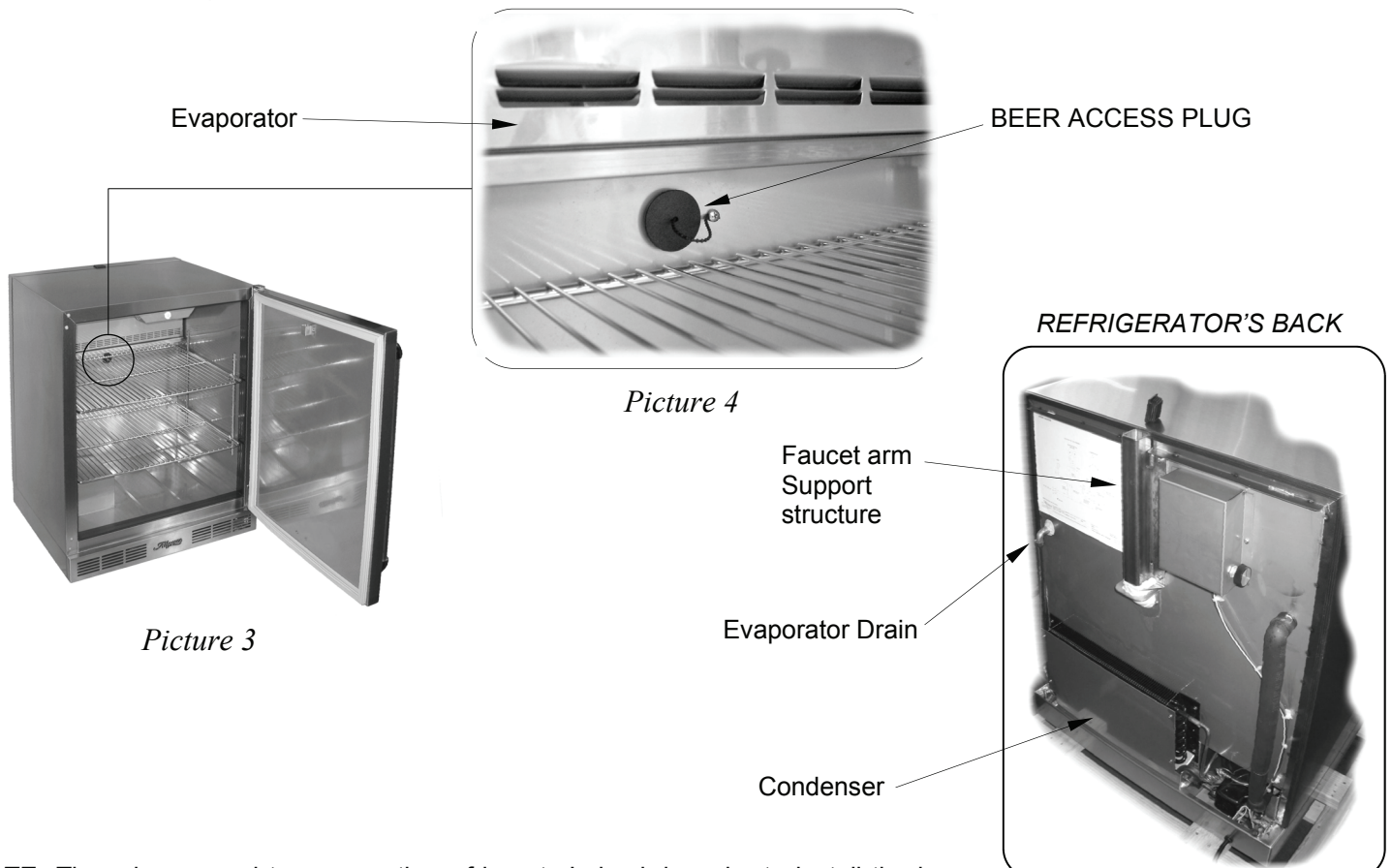

NOTE: There is no need to remove the refrigerator's back in order to install the beer line. Illustrations are for reference only.

WIRING DIAGRAM

EVAPORATOR COIL ASSEMBLY

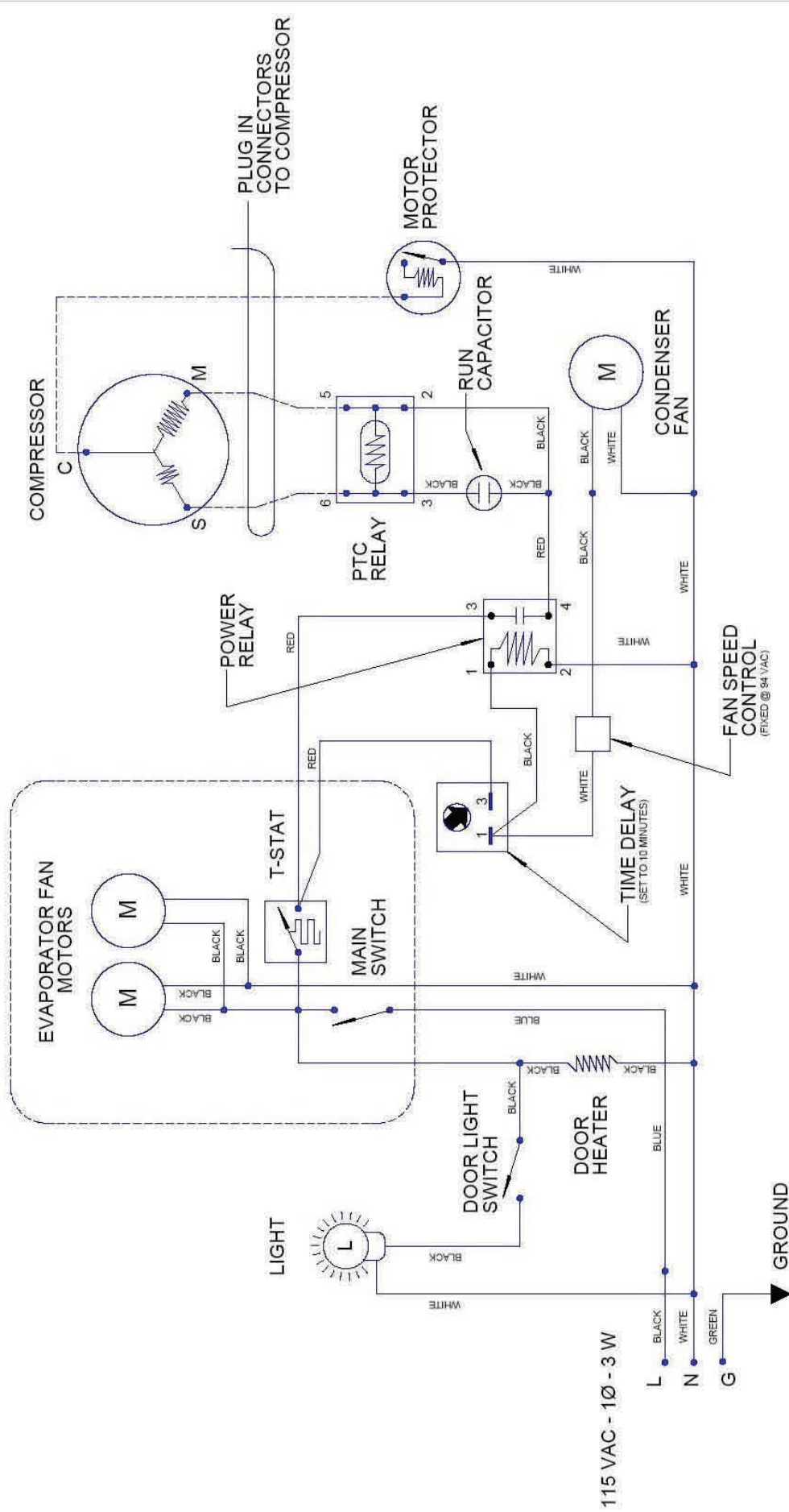

NOTE: CASE MUST BE GROUNDED

Alfresco
SUPERIOR EQUIPMENT SOLUTIONS
7039 EAST SLAUSSON AVENUE
COMMERCE, CA 90040

THE INFORMATION CONTAINED IN THIS WIRING DIAGRAM IS THE PROPERTY OF SUPERIOR EQUIPMENT SOLUTIONS, INC. ANY REPRODUCTION IN PART OR AS A WHOLE WITHOUT WRITTEN PERMISSION FROM SUPERIOR EQUIPMENT SOLUTIONS, INC. IS PROHIBITED.

CREATED: Wednesday, November 15, 2006 3:30:15 PM
DRAWN BY: ADRIAN CRISCI

PROJECT TITLE:
URS-1

DRAWING NO.:
W900-0026

DRAWING TITLE:
SERIAL NOS 06-10679 THRU 07-11724

SIZE: LETTER
SHEET 1 OF 1

SCHEMATIC DIAGRAM

EVAPORATOR FAN ASSEMBLY

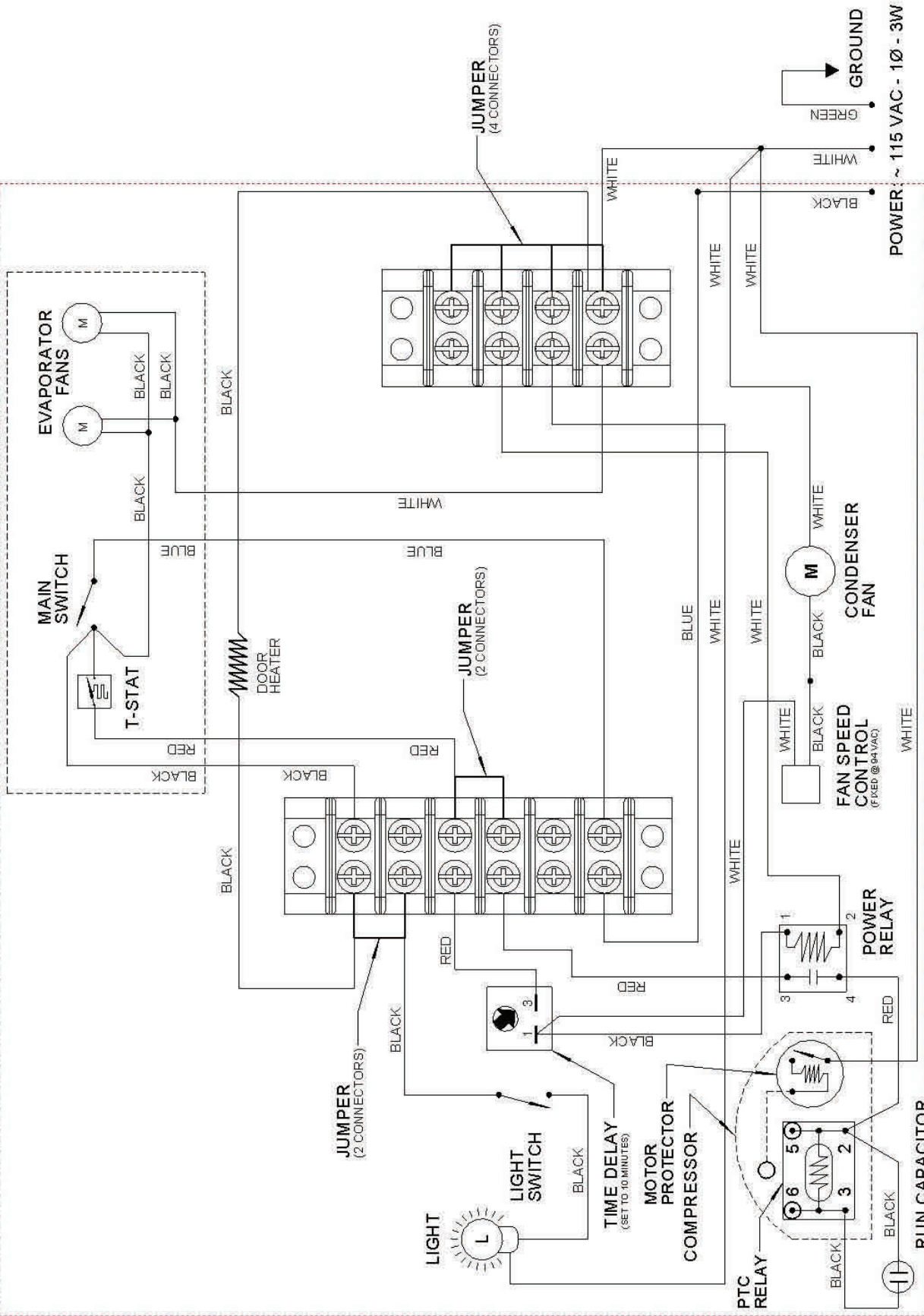

<p>THE INFORMATION CONTAINED IN THIS DRAWING IS THE PROPERTY OF SUPERIOR EQUIPMENT SOLUTIONS, INC. NO PART OF THIS DRAWING IS TO BE REPRODUCED OR TRANSMITTED IN ANY FORM OR BY ANY MEANS, WITHOUT WRITTEN PERMISSION FROM SUPERIOR EQUIPMENT SOLUTIONS, INC. IS PROHIBITED.</p> <p>Alfresco SUPERIOR EQUIPMENT SOLUTIONS 7039 EAST BLAUSSON AVENUE COMMERCIAL, CA. 90040</p>	<p>CREATED: Wednesday, November 15, 2006 8:30 AM DRAWN BY: ADRIAN CRISCI CHECKED BY: SES</p>	<p>PROJECT TITLE: URS-1</p>	<p>DRAWING NO.: W900-0027</p>
	<p>DRAWING TITLE: SERIAL NOS 06-10679 THRU 07-11724</p>	<p>SIZE: LETTER</p>	<p>SHEET 1 OF 1</p>

Alfresco[™] **Gourmet Limited Warranty**

This warranty covers the following: ALFRESCO GOURMET REFRIGERATORS (All Models)

DURATION OF WARRANTY

Alfresco Gourmet Grills, (a division of SES, Inc) warrants all refrigerator components to the original purchaser to be free of factory defects in material and workmanship for a period of one (1) year from the original date of purchase. This limited warranty covers the structural integrity of the exterior and interior body parts, compressor and refrigeration components. Should structural deterioration occur to the degree of non-performance, a replacement will be furnished FOB Commerce, California. This warranty does not apply if the unit was subject to other than normal household use.

Alfresco Gourmet Grills WILL Cover:

All repair labor and replacement parts for one year, for parts found to be defective due to materials or workmanship. Authorized Factory Agent must provide Service during normal working hours. No charge will be made for repair and/or replacement or components at the factory for parts returned pre-paid, through the dealer and claimed within the warranty period, and found to be defective by Alfresco Gourmet Grills.

Alfresco Gourmet Grills WILL NOT cover:

- Installation or start-up
- Normal adjustment to temperature
- Damage resulting from accident, alteration, misuse, abuse, hostile environments, improper installation or installation not in accordance with local codes.
- Cleaning and/or general maintenance.
- Shipping damage
- Service by an unauthorized agency.
- Damage or repairs due to service by an unauthorized agency.
- The use of unauthorized parts.
- Overtime, weekends, holidays
- Improper installation, such as: improper hook-up, inadequate ventilation, etc

- Service visits to:
 - Correct the installation. (You are responsible for providing electrical wiring, and other connecting facilities.)
 - Repairs due to other than normal use.
 - Supply the user with operational assistance on site.

Replacement will be FOB Alfresco, Commerce, California, and Alfresco will not be liable for any transportation costs, labor costs, or export duties. This warranty shall not apply, nor can we assume responsibility for damage that might result from failure to follow manufacturers instructions or local codes, where the appliance has been tampered with or altered in any way or which, to our judgment, has been subjected to misuse, negligence, or accident. Implied warranty shall not extend beyond the duration of this written warranty. This warranty is in lieu of all other warranties expressed or implied and all other obligations or liability, in connection with the sale of this appliance.

FOR SERVICE, CALL: 1 866 203 5607

When calling, please provide the following information: model number, serial number and date of installation, along with a brief description of the problem. The model number and serial number can be found on a plate located near the top of the inside left wall.

For other product information, contact: Alfresco Gourmet Grills. 7039 East Slauson Ave, Commerce, CA 90040.

NOTES

SAffresco™

TM

*Alfresco*TM

Open Air Culinary Systems

URS-1 • CARE & USE MANUAL
ALFRESCOTM GOURMET GRILLS
ALL RIGHTS RESERVED • 01/2007