

*Alfresco*

*ARFG-42*

*SERVICE AND PARTS*

*MANUAL*



**GENERAL COMPONENT LOCATION:**

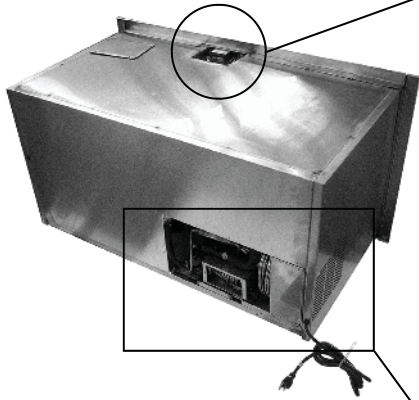

**CONTROLLER LOCATION AND  
MAIN POWER SWITCH (COVER REMOVED)**

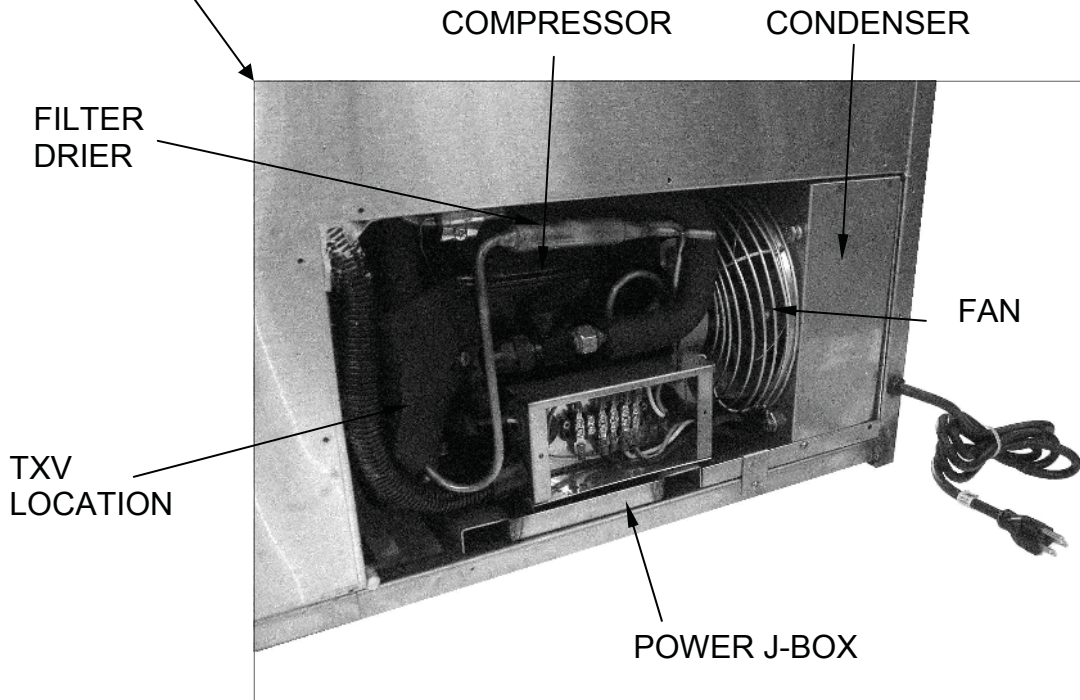

**EVAPORATOR  
ASSEMBLY**

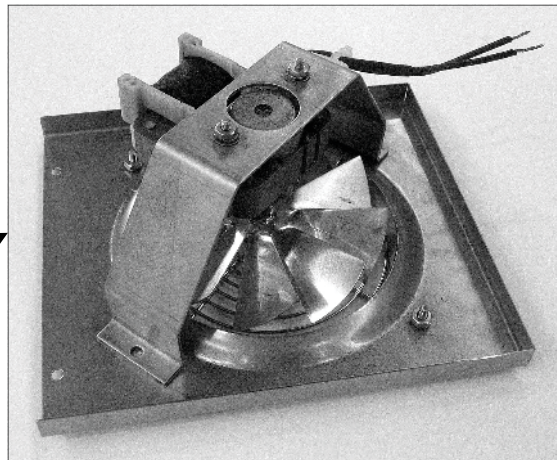
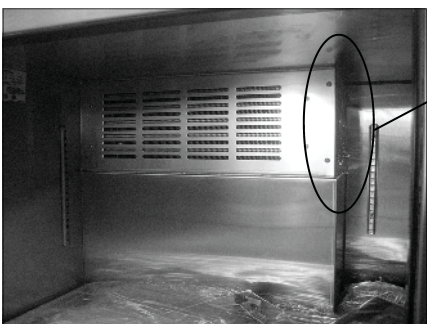

**EVAPORATOR  
FAN REMOVED  
FOR REPLACEMENT.  
REMOVE PLATE  
AND BRACKET  
FOR FAN MOTOR  
REPLACEMENT.**

## **TROUBLESHOOTING AND SERVICE GUIDE:**

The following is intended as a quick service guide designed to diagnose most common problems. It is intended to be used only as a guideline. Should the unit require actual replacement of components those must be done by a trained and licensed refrigeration professional. While the unit is within the factory warranty period, all repairs require prior factory authorization before the work is actually performed.

### **UNIT NOT COOLING:**

- **POWER TO THE UNIT:** Is there power to the unit?. Is the voltage within  $\pm 10\%$  of 115 VAC? Low power conditions affect the amperage draw of the compressor, requiring more amperes on start up. If the amperage draw is too high, the compressor safety relay could trip leading to component premature failure. If the compressor is tripping on its safety relay on startups, the unit will not refrigerate as required.
- **COMPRESSOR NOT RUNNING:** Is the compressor not running when the controller calls for cooling to begin?. (see point above). Verify that power to the compressor is correct and the starter and safety relays are working properly.
- **CONDENSER FAN NOT RUNNING:** Is the compressor running but not the condenser fan? The condenser fan is on the same circuit as the compressor. They both operate at the same time. Verify that the condenser fan receives power and the fan blades rotate freely. Verify if there is debris in the blades that prevents it from starting (ie: leaves, paper, grass clippings, etc...)
- **VENTILATION IN THE UNIT:** Does the unit have enough ventilation on the back to allow for free cool air to reach the condenser? Many installations have no outside ventilation reaching the condenser as they place the unit into a closed space that only re-circulates air discharged from the condenser "back" to the condenser reducing performance drastically. Verify that there is an outside source for fresh air into the condenser.

### **NOT HOLDING TEMPERATURE CORRECTLY:**

- **CONTROL SET POINT:** Is the unit operating with the correct set point? Please verify according to the list provided in the controller programming on the following chapter of this booklet.
- **OPERATING DIFFERENTIAL:** The unit operates in a 3 degree differential on average depending on the quantity of items in the unit. The unit will cycle ON and OFF several times so the product temperature is an average of the cycle. (see section "Understanding the refrigeration cycle")
- **DEFROST MODE:** Is the unit currently in defrost mode?. The unit defrosts until the coil temperature reaches 50°F. This is not the temperature of the product, this is just the air temperature during defrost.

- **EVAPORATOR COIL ICED UP:** Is the evaporator coil iced up due to incorrect (too low) of a set point? Verify that the unit defrosts properly and the evaporator coil is clean of heavy frosting during operation.

#### **NOISY OPERATION:**

- **DEBRIS IN THE FAN BLADE:** Is there debris in the condenser fan blade? Not only can debris physically stop the fan blade from rotating (as discussed previously), but it can also block airflow thus preventing the unit from cooling. As the air gets hotter in the unit from lack of airflow, the condenser fan will increase speed to allow more airflow.
- **FULLY STOCKED:** Is the unit fully stocked? If the unit is not properly stocked or half empty the unit will have to work harder. Air does not hold temperature, products do. If there is not product in the refrigerator the unit will turn ON and OFF several times per hour. If the unit is fully stocked, the run-time will be extended but also the off-time allowing the compressor to cool down properly between cycles. This will help the unit run more efficiently as several runs per hour will increase compressor temperatures thus requiring to work harder to cool down.
- **TUBING RUBBING:** Are there any tubes in the compressor area rubbing against each other? Is there any rubbing between the tubing and the condenser fan housing or fan motor itself? The installation of components at the back of the unit requires to have components closed together. During shipment and installation some of these components might shift rubbing each other. Please verify there are no lines rubbing or too close together as to touch when operating.

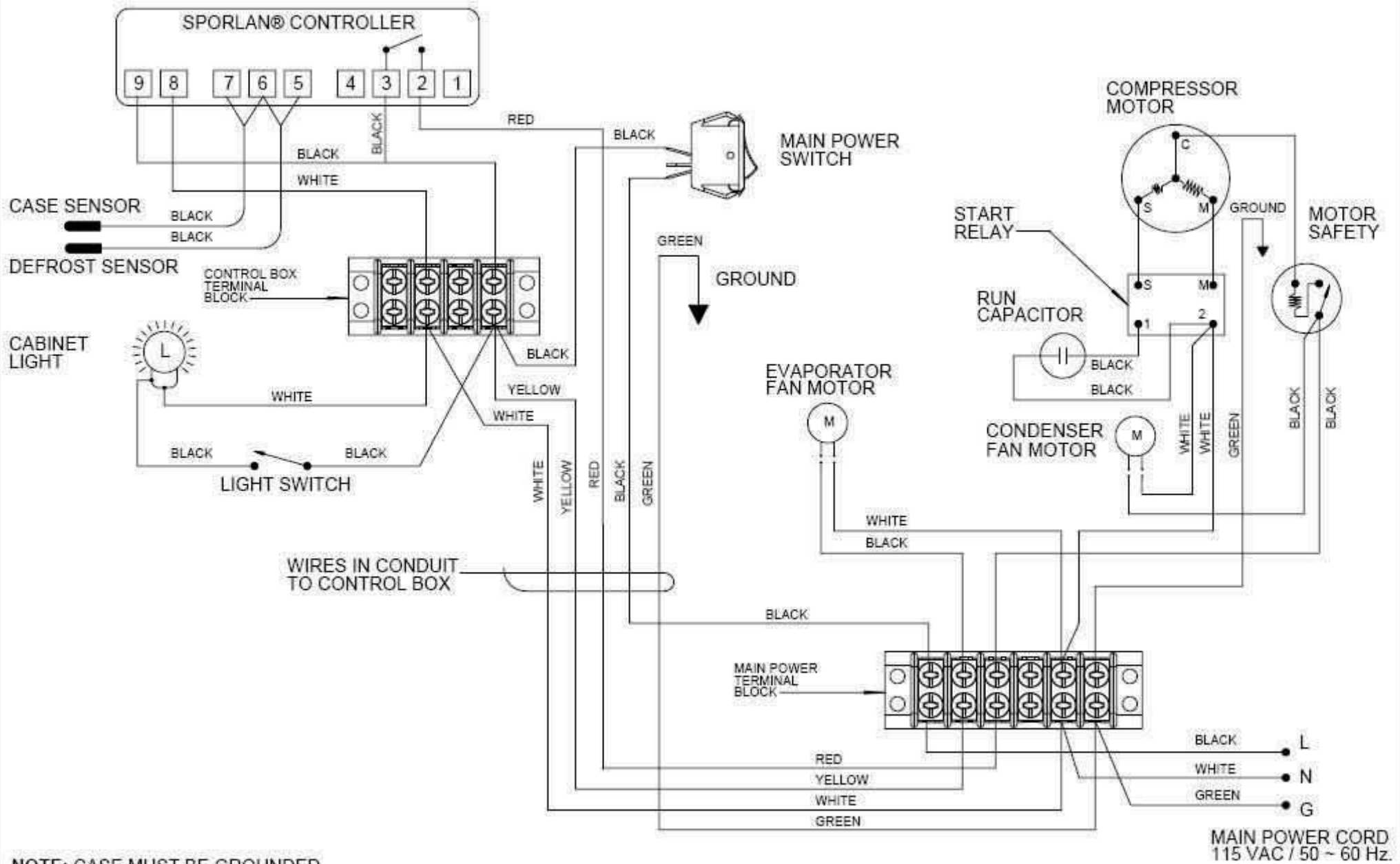

## CONTROLLER SETTINGS AND ADJUSTING TEMPERATURES :

Your *ALFRESCO* refrigerator features an exclusive digital programmable thermostat (*see figure 1*) that controls all functions of the unit. The operating temperature of the unit is user-adjustable from 25°F to 45°F.

The refrigeration control has been preset at the factory for normal, everyday operation under standard room conditions. Should you require to change the temperature setting, higher or lower than the standard factory set of 35°F, this procedure can be done very quickly, as follows:

1. Press the "SET🔔" button for 1 second to display the set point temperature (35°F) default.
2. Hold the "SET🔔" key until the set point starts flashing.
3. Use the ▲❄️ key to increase the temperature or ▼❄️ key decrease the temperature.
4. Press the "SET🔔" button once more to confirm the value. The display will stop flashing.

Note: The ▲ "UP" and ▼ "DOWN" keys also serves as indicator lights to show when the compressor is ON or when the unit is on DEFROST mode.

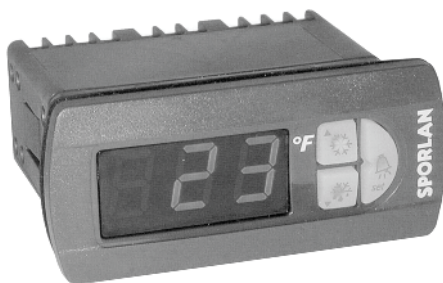

Figure 1

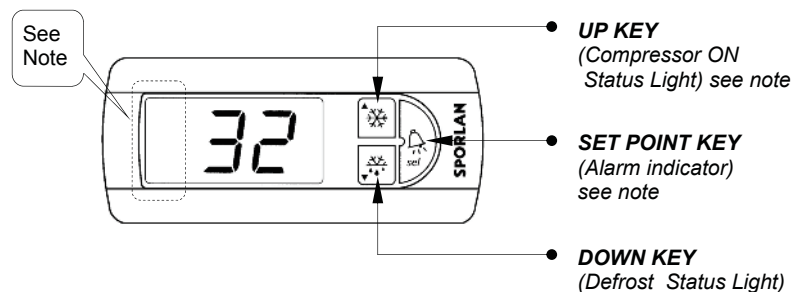

Figure 2

### ADJUSTMENTS ITEMS TO REMEMBER:

- ▶ **FOR NORMAL OPERATION SET THE UNIT TO 35°F.**
- ▶ **PLEASE NOTE THAT THIS IS NOT THE INTERNAL REFRIGERATOR CABINET TEMPERATURE.**
- ▶ **DO NOT CHANGE THE TEMPERATURE SETTING MORE THAN 3°F AT A TIME.** (*This does not apply when adjusting the unit to the default setting or making broad adjustments to a desired setting for permanent use*)
- ▶ **ALLOW 24 HOURS FOR THE REFRIGERATOR TO REACH A NEW TEMPERATURE SETTING.**
- ▶ **THE MOTOR WILL START AND STOP OFTEN. THIS IS NORMAL OPERATION.**
- ▶ **KEEP YOUR REFRIGERATOR LEVELED.**

**NOTE:** Depending on the controller *revision model*, it will either have indicator lights on the buttons themselves (*see figure 2*) or (newer models) will have indicator symbols on the left side of the display. If so, these 3 status symbols will indicate the following:

- 🔔 Shows when the compressor is ON
- 🔔 Shows that there is an ALARM
- ❄️ Shows the unit is on DEFROST

## OPERATIONAL PARAMETERS

There are two sets of parameters that can be access on this controller. Some require a password, other do not.

1. Press the “SET🔔” button for **1 second** to display the set point temperature (**35°F**) default.
2. Hold the “SET🔔” key for at least **5 seconds once more** (the set point starts flashing and after 5 seconds the letters PS will appear on the screen). PS = PASSWORD
3. Release the “SET🔔” key.
4. At this point, press the “SET🔔” once more and use the ▲❄️ or ▼❄️ keys to reach the number 22 on the screen (this is your password).
5. Press the “SET🔔” key once more to return the display to “PS”.
6. Use the ▲❄️ or ▼❄️ keys to cycle through the different programming parameters.
7. ALWAYS Press the “SET🔔” button for at least **5 seconds** to exit the programming mode.

### Review:

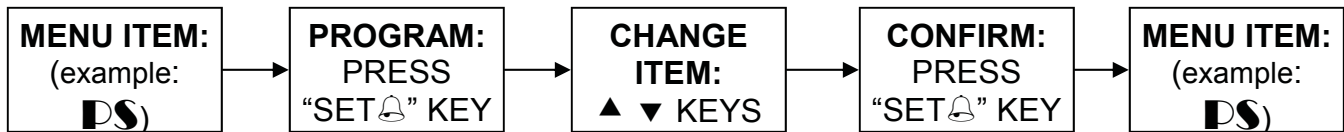

Please verify all programmed operational variables according to the list on the following page.  
The ARFG-42 unit should now operate with peak efficiency.

**Sporlan™ OMNI-Stat® Controller Settings**

◀ Values to be changed from default

Model: 952892 - 120 VAC

Code:	Parameter:	Value	Default	UOM	Access	
					W/O PS	With PS
<b>PASSWORD</b>						
PS	Password	22	22	#	✓	
<b>PROBE PARAMETERS</b>						
/c	Ambient probe calibration	0	0	°F	✓	
/2	Measurement Stability	4	4	~		✓
/4	Probe to display (0=ambient / 1=product)	0	0	~		✓
/5	Unit of Measure (0=°C / 1= °F)	1	0	~		✓
<b>REGULATION PARAMETERS</b>						
rd	Regulating Differential	3	2	°F	✓	
r1	Minimum Allowed Temperature setting	25	-50	°F		✓
r2	Maximum Allowed Temperature setting	45	60	°F		✓
r3	Enable Def. alarm when max def. time reached	0	0	~		✓
r4	Automatic variation of set point - <b>NOT USED</b>	3	3	~		✓
<b>COMPRESSOR PARAMETERS</b>						
c0	Delay compressor after power on	0	0	Minutes		✓
c1	Minimum time between 2 compressor runs	0	0	Minutes		✓
c2	Compressor shut down minimum time	2	0	Minutes		✓
c3	Compressor Operation minimum time	0	0	Minutes		✓
c4	Compressor Safety (0=OFF / 100=ON)	100	0	~		✓
cc	Continuous Cycle Duration	4	4	Hours		✓
c6	Alarm Delay after continuous cycle	2	2	Hours		✓
<b>DEFROST PARAMETERS</b>						
d0	Defrost type (0=heater / 1=Hot Gas / 2=timed)	2	3	~		✓
dl	Defrost interval	4	8	Hours	✓	
dt	Defrost Ends Temperature	50	4	°F	✓	
dP	Max. Defrost Duration	30	30	Minutes	✓	
d4	Defrost after power on (0= NO / 1= YES)	0	0	~		✓
d5	Defrost delay after power on	0	0	Minutes		✓
d6	Block Display during Defrost (0= NO / 1= YES)	1	1	~		✓
dd	Dripping time after defrost	2	2	Minutes	✓	
d8	Alarm delay after defrost	1	1	Hours	✓	
d9	Defrost priority over minimum compressor time (0= NO / 1= YES)	0	0	~		✓
d/	Defrost probe - display temperature	~	~	~	✓	
dc	Time base for dl and dP (0= hrs / 1= minutes)	0	0	~		✓
<b>ALARM PARAMETERS</b>						
A0	Alarm and Fans Differential Temp	0	0	°F		✓
AL	Low temperature alarm (0= OFF)	0	0	°F	✓	
AH	Hight temperature alarm (0=OFF)	0	0	°F	✓	
Ad	Alarm Temperature delay	0	0	Minutes		✓
A7	Alarm input detection delay	0	0	Minutes		✓
<b>OTHER PARAMETERS</b>						
H0	Serial Address (communications)	1	1	~		✓
H1	Alarm Relay Operation (0=Alarm w/relay ON -	1	1	~		✓
H2	0= Disable Buttons / 1=Enable Buttons	1	1	~		✓
H5	Identification for Programming	0	0	~	✓	
T	External Programming	~	~	~	✓	



## UNDERSTANDING THE REFRIGERATION CYCLE:

The Refrigeration Controller unit that manages all the refrigerator operations and performance is a rugged and highly sophisticated commercial grade Sporlan Electronic Controller.

Like all refrigerators, as the unit cools and maintains the desired product temperature, its internal temperature will fluctuate between ON and OFF periods depending upon ambient temperature, how many times the door is open and for how long it's held open.

To minimize ON (running) times and save energy, it is recommended to open the door for the smallest amount of time and frequency.

***The ARFG-42 unit is factory preset with a set point of 35°F and with a 3°F differential cycle.***

This means that the ARFG-42 unit will refrigerate until it reaches 35°F internal air temperature. At that point, the unit will turn OFF and will remain off until it reaches 38°F (Due to the 3°F differential temperature cycle).

It is important to understand that your product **will not** actually reach 38°F.

The "average" product temperature will settle somewhere midway between the ON and OFF set points (approximately ~37°F) depending on the product type.

Please refer to the following graph for a representation of the refrigeration cycle:

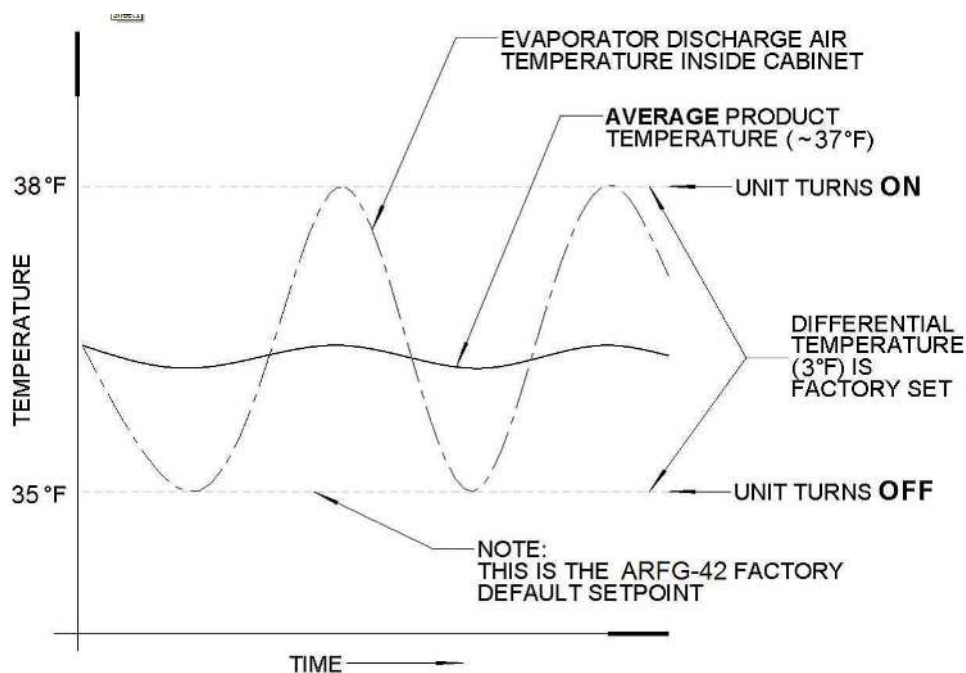

The 3°F differential is used to provide you with the best possible energy savings. A smaller differential would cause the unit to start and stop several times per hour wasting energy.

The Electronic Temperature Controller in the ARFG-42 allows the user to change and adjust the default set point (35°F) between 25°F and 45°F, consequently the product temperature will average lower or higher temperatures as desired.

Please refer to "CONTROLLER SETTINGS"

*Always remember:*

When the door is opened on the ARFG-42, the display will read the cabinet temperature at that very moment. That is not your product temperature.

## ARFG-42 SERVICE PARTS LISTING:

The following is a list of all components and or hardware that are serviceable on the ARFG-42 refrigerator unit. Please refer to the picture and attached text for reference and identification.

### ELECTRICAL COMPONENTS:

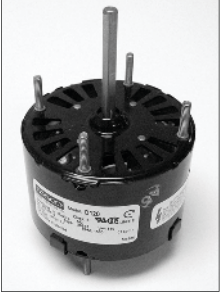

CONDENSER FAN  
210-0105

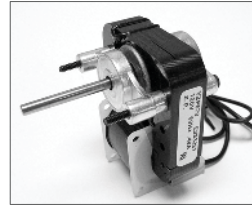

EVAPORATOR FAN  
210-0265

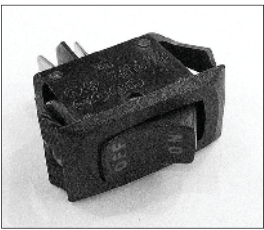

MAIN POWER SWITCH  
210-0021

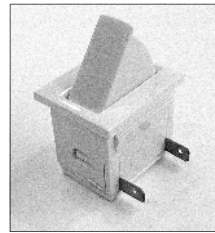

LIGHT SWITCH  
210-0298



LIGHT BULB (COATED)  
210-0245



TEMPERATURE  
CONTROLLER KIT  
210-0030



MAIN POWER  
CORD  
210-0287



TEMPERATURE CONTROL  
SENSOR (2) REQUIRED  
210-0031

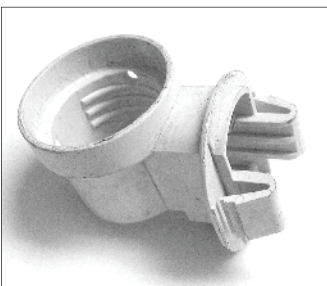

LIGHT SOCKET  
210-0314

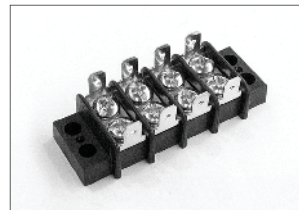

4 POSITION  
TERMINAL BLOCK  
210-0301

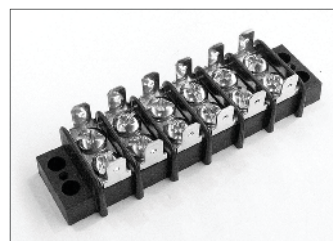

6 POSITION  
TERMINAL BLOCK  
210-0302

**REFRIGERATION COMPONENTS:**



**REFRIGERANT  
COMPRESSOR  
260-0055**



**THERMAL EXPANSION  
VALVE  
220-0004**



**SAFETY OVERLOAD  
210-0391**



**REFRIGERANT TXV  
ORIFICE  
220-0009**



**FILTER  
DRIER  
220-0029**



**RELAY  
210-0392**

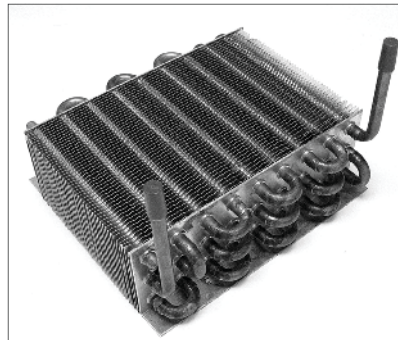

**CONDENSER  
COIL  
250-0061**



**CAPACITOR  
210-0393**

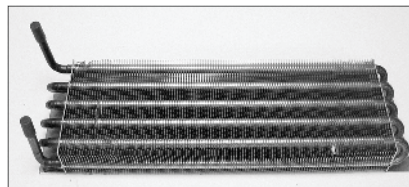

**EVAPORATOR  
COIL  
250-0057**

**NOTE: PART NUMBERS 210-0391, 210-0392  
AND 210-0393 ARE REPLACEMENT PARTS  
FOR THE COMPRESSOR ASSEMBLY.**

**HARDWARE COMPONENTS:**

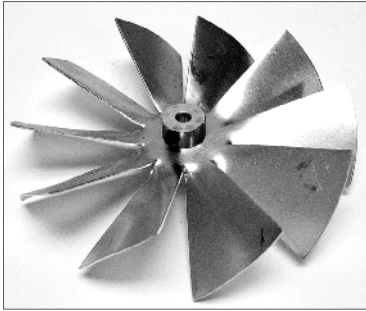

EVAPORATOR  
FAN BLADE  
210-0315



SHELF PILASTERS  
290-0186  
QTY. (4)



FOOD PAN  
1/2 SIZE X 6" D  
290-0130  
QTY. (2)



SHELF CLIP  
290-0140  
QTY. (4)



CONDENSER  
FAN BLADE  
210-0250

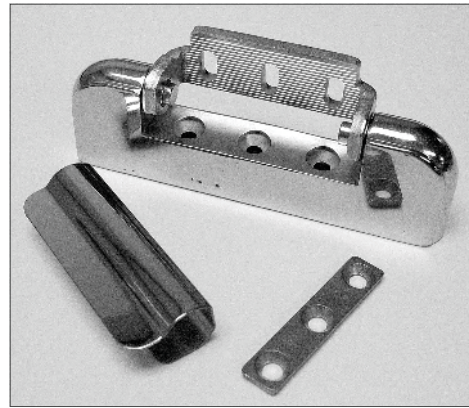

DOOR HINGE  
REPLACEMENT  
KIT  
290-0155

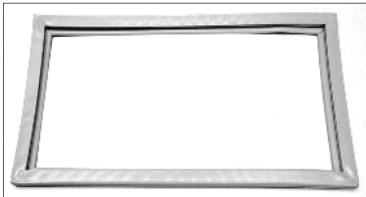

DRAWER GASKET  
290-0164

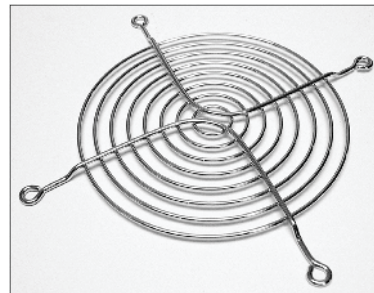

EVAPORATOR COIL  
FINGER GUARD  
200-0182



DOOR GASKET  
290-0165



CONDENSER FAN  
FINGER GUARD AND  
MOTOR MOUNT  
210-0253

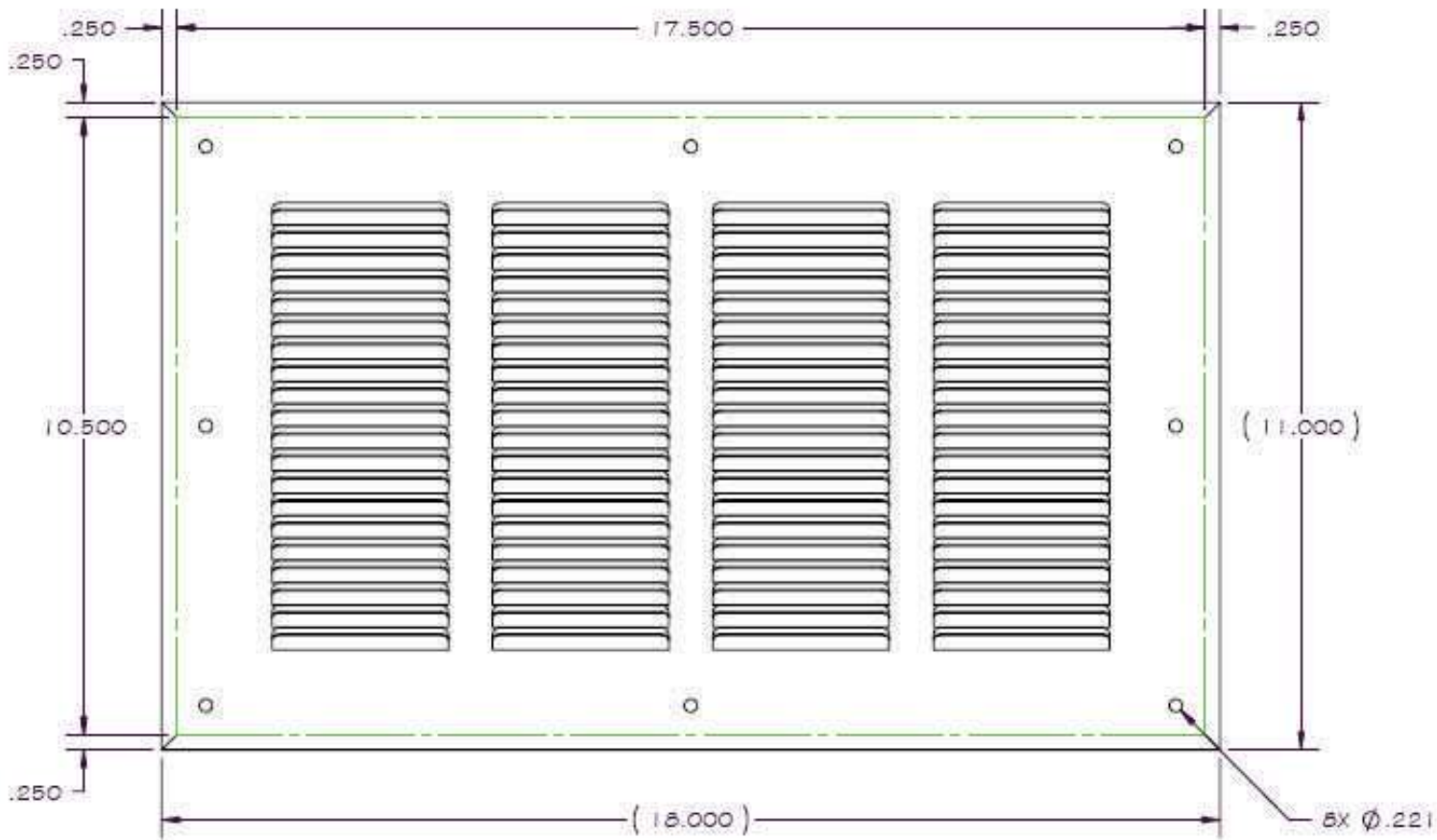
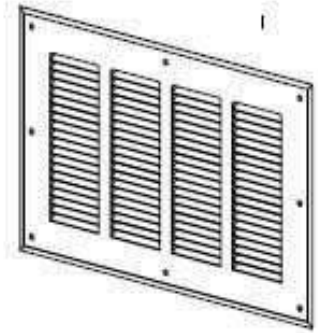

ALL BENDS KINK UP 5.

NOTE: PART IS DRAWN GOOD SIDE DOWN LOUVERS UP.

**Alfresco**  
 SUPERIOR EQUIPMENT SOLUTIONS  
 7039 EAST OLAUSON AVENUE  
 COMMERCE, CA, 90040

THE INFORMATION CONTAINED IN THIS DRAWING IS THE SOLE PROPERTY OF SUPERIOR EQUIPMENT SOLUTIONS, INC. ANY REPRODUCTION IN PART OR AS A WHOLE WITHOUT WRITTEN PERMISSION FROM SUPERIOR EQUIPMENT SOLUTIONS, INC. IS PROHIBITED.  
 L/S By: neil  
 L/S By: Wednesday, June 21, 2006 10:36:10 AM

DRAWN BY: Neil Silcock  
 MATERIAL: 20G SS  
 FINISH: 4F  
 WEIGHT: 2.057 Lbs.  
 C:\Working\

CREATED: Wednesday, June 21, 2006 9:36:17 AM  
 CUSTOMER:  
 SES

PROJECT TITLE:  
**ARFG-42**  
 DRAWING TITLE:  
**LOUVER PANEL FOR ISLAND**

DRAWING NO.:  
**130-1636**  
 SIZE: A  
 SHEET 1 OF 1



## ARFG-42 VENTILATION REQUIREMENTS

An adequate source of fresh air must be provided, along with adequate opening to exhaust hot air from the compressor and the island

NOTE: THIS DOCUMENT MUST BE PRINTED IN COLOR.

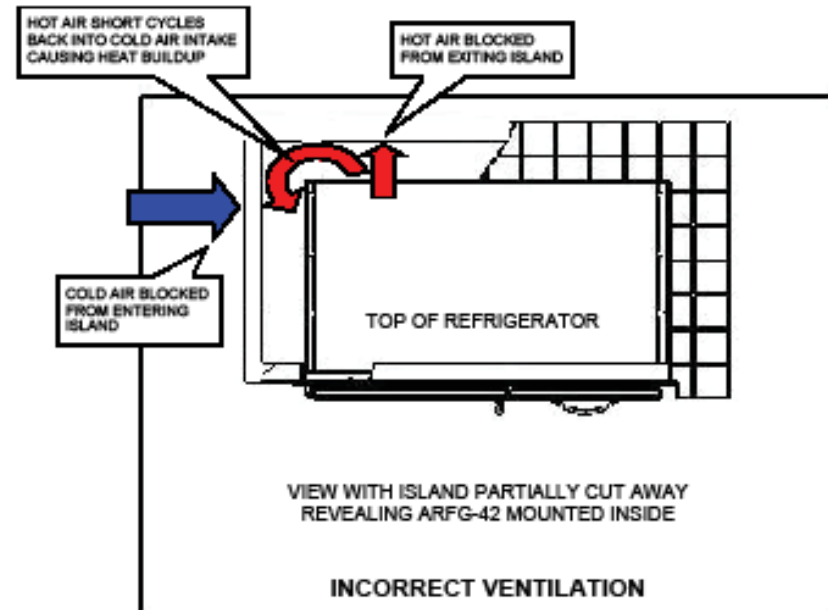
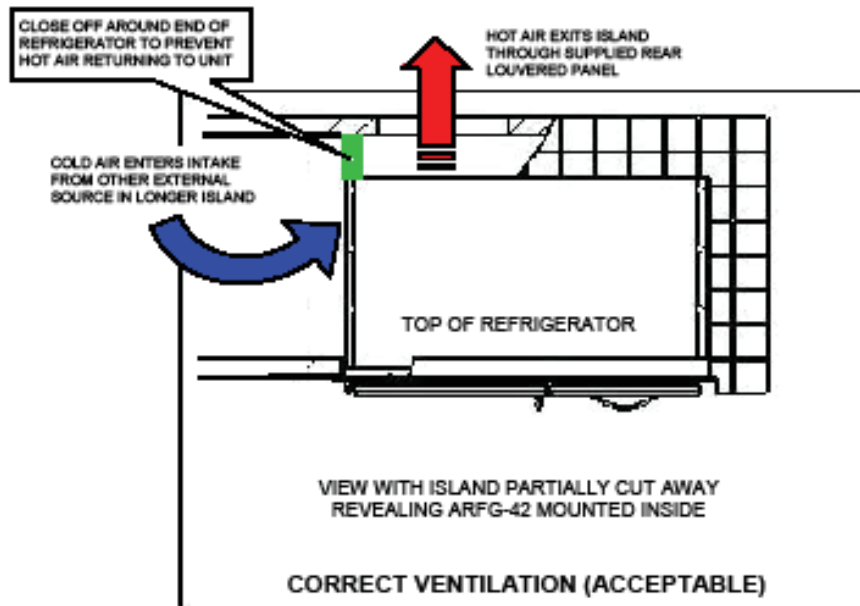
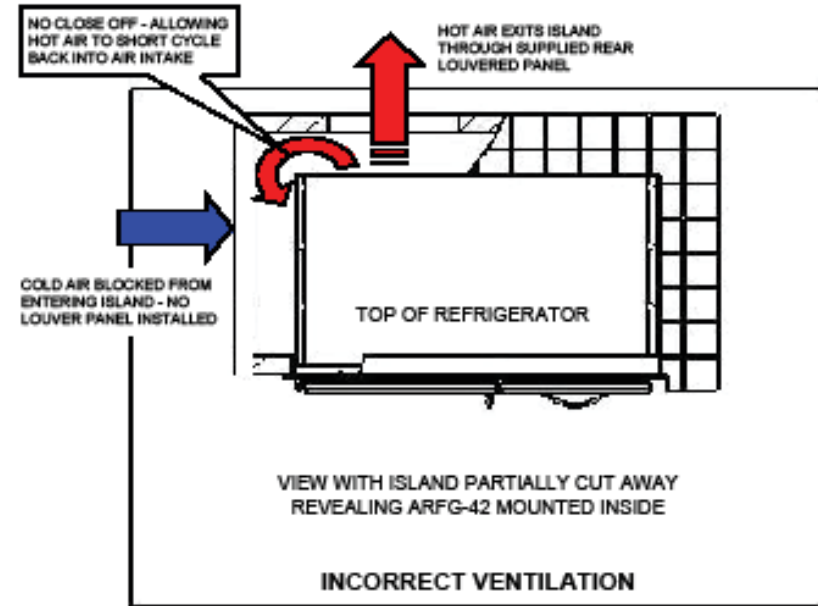
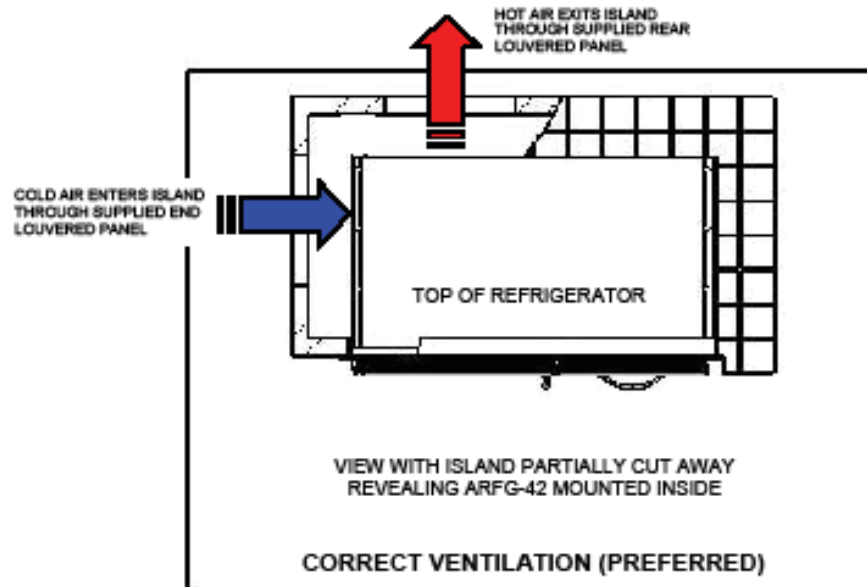

## **(ARFG-42 SERVICE DATA)**

### ***ELECTRICAL:***

- *VOLTAGE: 115VAC*
- *FREQ: 60 Hz*
- *PHASE: 1*
- *AMPS: 6.0*
- *RLA: 5.6*
- *LRA: 29.0*
- *Min.Circuit Ampacity: 10.0*
- *Max. Over current Protection: 15.0*

### ***REFRIGERATION:***

- *REFRIGERANT: 134A (8oz)*
- *LOW SIDE: 18 PSI (RANGE 12-21)*
- *HIGH SIDE: 124 PSI (RANGE 100-165)*

---

## **HOW TO OBTAIN ADDITIONAL HELP AND SERVICE:**

For service, please contact our Alfresco™ Gourmet Grills authorized service agency at:

**1 (866) 203-5607**

Please provide:

- Model Number
- Serial Number
- Date of installation
- A brief description of the problem.

For all other Alfresco™ Gourmet Grill product inquiries please contact:

Alfresco Gourmet Grills.  
Customer Service Department.  
7039 East Slauson Avenue  
Commerce, CA 90040.

(888) 383-8800 or (323) 722-7900  
(323) 726-4700. (fax)

Visit us on the WEB at: [www.alfrescogrills.com](http://www.alfrescogrills.com)