

X20-7.4-M-820-* Technical Specification

X20-12-M-820-*

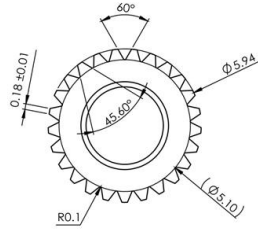

25T 6mm Output Shaft Spline

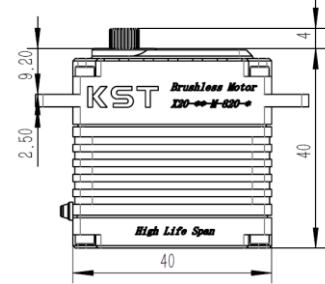
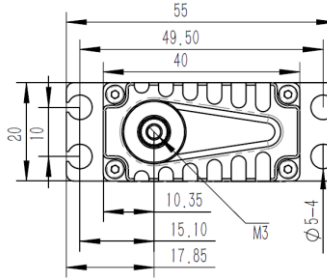

1. Operating Data

	X20-7.4-M-820-*	X20-12-M-820-*
Rated Voltage	DC7.4V	DC12.0V
Voltage Range	DC6.0V-8.4V	DC9.0V-13V
Stalling Torque	3.0N.m@7.4V	3.5N.m@12V
Rated Torque	0.7N.m@7.4V	0.9N.m@12V
Stalling Current	4.95A	3.25A
Rated Current	1.25A	0.85A
No-load Speed	0.09sec/60°@7.4V	0.09sec/60°@12V
Rated Speed	0.17sec/60°@7.4V	0.14sec/60°@12V
Working Frequency	1520us/333Hz	
Default Travel Angle	± 100°=200°Total When 500us-2500us	
Temperature Range	-10°C.....+65°C	
Case Material	Aluminum Alloy	
Motor Type	Brushless DC Motor	
Gear Set Material	Hardened Steel	
Position Sensor	Contactless	
Case Dimensions	40mm*20mm*40mm±0.2mm	
Weight	75g±10%	
Ball Bearing	6 BB	

2. Performance

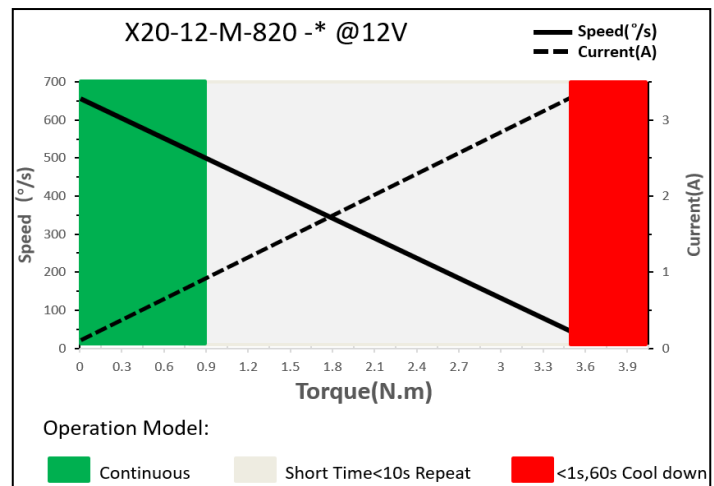
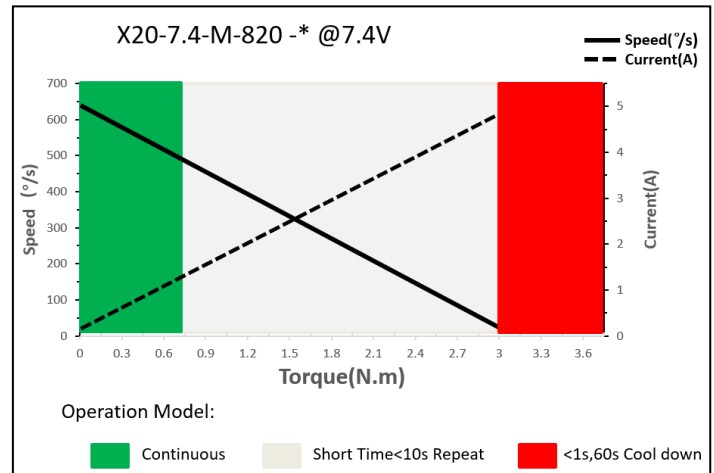

3. Command signal

3.1. PWM Command Interface

Signal Voltage	TTL-level: HIGH: min.3.3V, max.5.0V Low: min.0.0V, max.1.5V
Pulse Lengths	500us-2500us
Pulse Lengths for Position-100% 0°/+100°	500us/1500us/2500us

3.2. RS485 Command Interface

Baud-Rate	115200 ±1.5% bits/s
Protocol (Documentation available)	10 Byte (incl. 1 byte Check Sum)

3.2.1. RS485 Protocol Specifications

Number of Data Bits	8
Number of Stop Bits	1
Parity	None

3.2.2. Command / Response Frame

Byte #	Description	Byte #	Description
1	Frame Head(0xFE)	6	Data
2	Version(0xCA)	7	Data
3	Address	8	Data
4	Command code	9	Check Sum
5	Data	10	(0A) Frame End

3.3. CAN Bus Command Interface

Baud-Rate	500Kbps
Node number	0 x25 (range 1 ~ 127, 0 is radio)
Communication	3.1: CAN Open standard frame format 3.2: CAN Open Extended frame

3.4. Feedback Singnal

3.4.1. Position Feedback Signal (PWM Versions)

The Position Feedback signal is an output signal with a square wave which is directly related to the output shaft's angular position. Reference is Supply Ground.

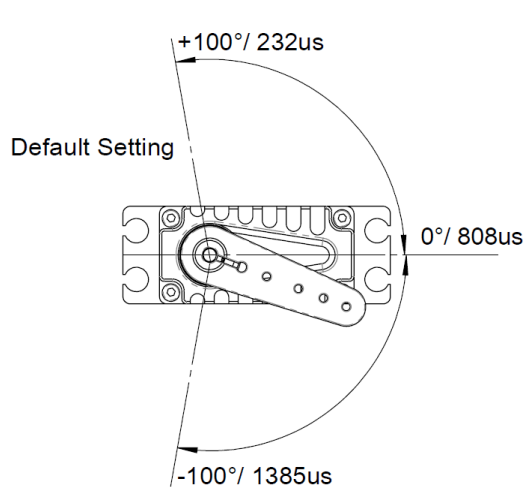

Position Feedback

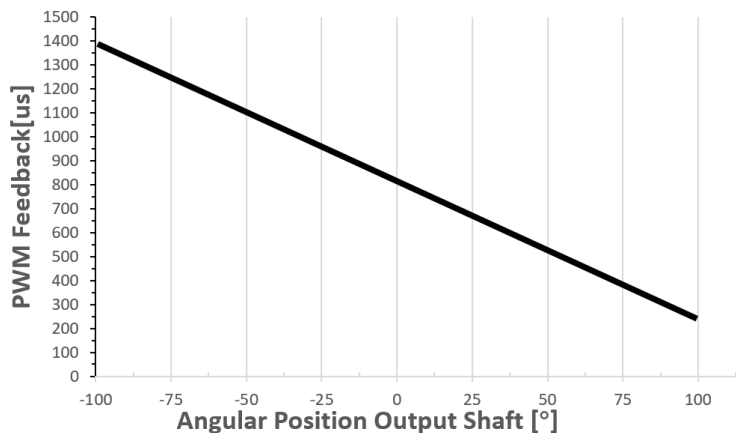

* Tolerance ±1%

4.4.2 Feedback Value (Bus Versions)

Integrated in the Bus protocol a Feedback Value, including the Angle position, Temperature, current value. Value read by sending request command. Provide the details of the bus in the document.

4. Electrical Connection Options

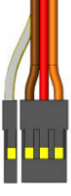
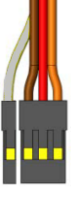
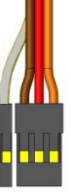
 4 3 2 1	Pin Assignment (PWM)			
	1	Yellow	SIG	Command Signal
	2	Red	DC+	Supply Voltage
	3	Brown	DC-(GND)	Supply Ground, Signal Ground
 4 3 2 1	Pin Assignment (RS485)			
	1	Yellow	RS485A	Non-Inverted Input / Output line
	2	Red	DC+	Supply Voltage
	3	Brown	DC-(GND)	Supply Ground, Signal Ground
 4 3 2 1	Pin Assignment (CAN_BUS)			
	1	Yellow	CAN_H	CAN high
	2	Red	DC+	Supply Voltage
	3	Brown	DC-(GND)	Supply Ground, Signal Ground
4	white	CAN_L	CAN low	

5. Accessories (Options)

Item	Item-No.
Aluminum Servo Arm (Single side)	0625.11
Aluminum Servo Arm (Single side)	0625.23
Aluminum Servo Arm (Single side)	0625.40
Aluminum Servo Arm (Double side)	0625.60

6. Item Number System

