



Le cahier de jeux

Édition Dinosaures

4 à 6 ans

Ce carnet appartient à :

.....
.....

Nos dinosaures ont perdu leurs silhouettes,
colorie celles qui leur correspondent

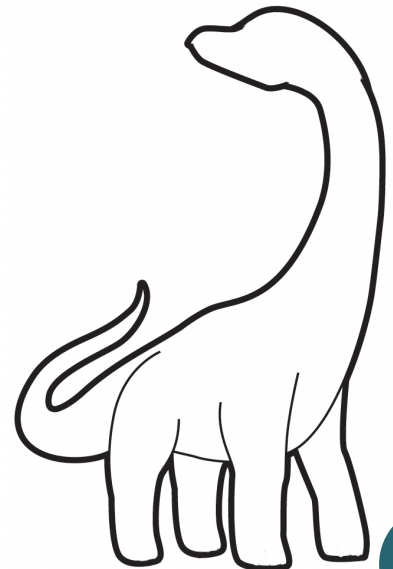
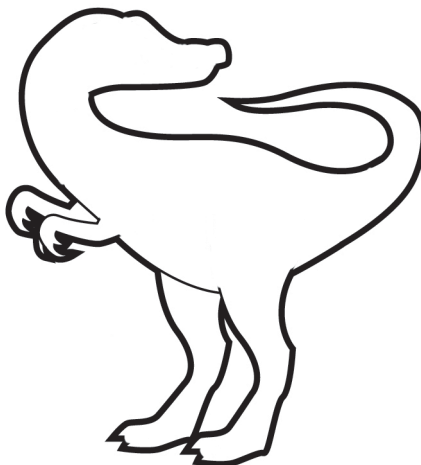
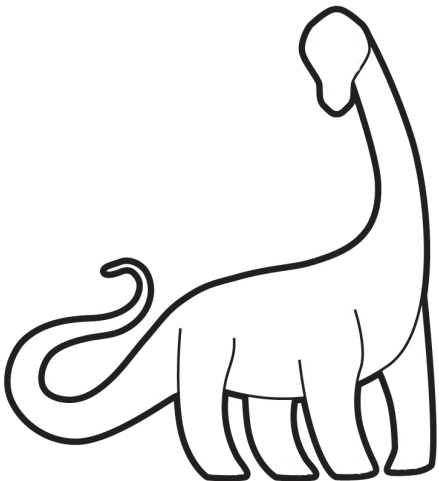
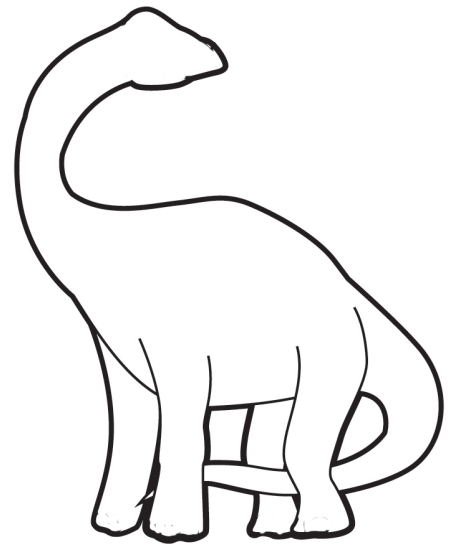
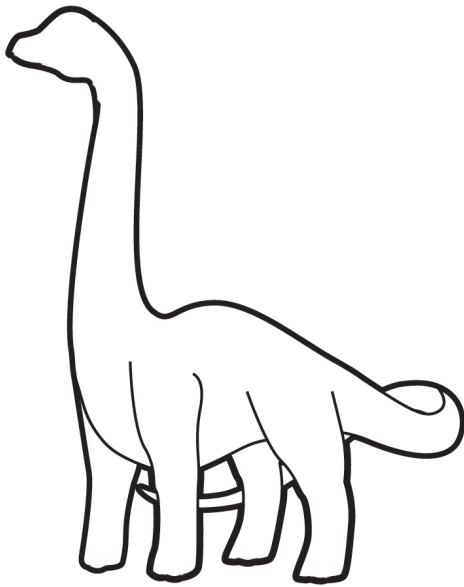
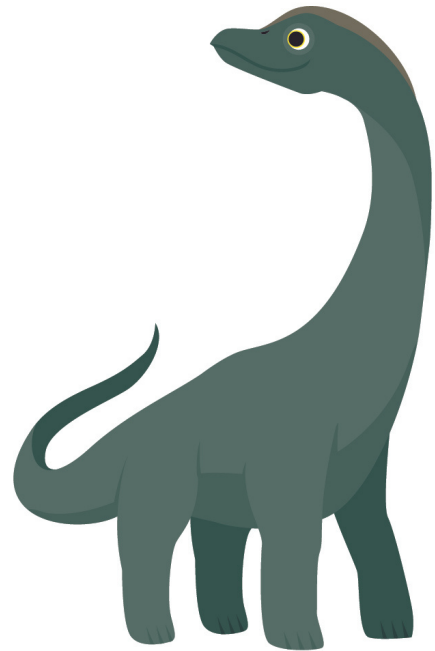
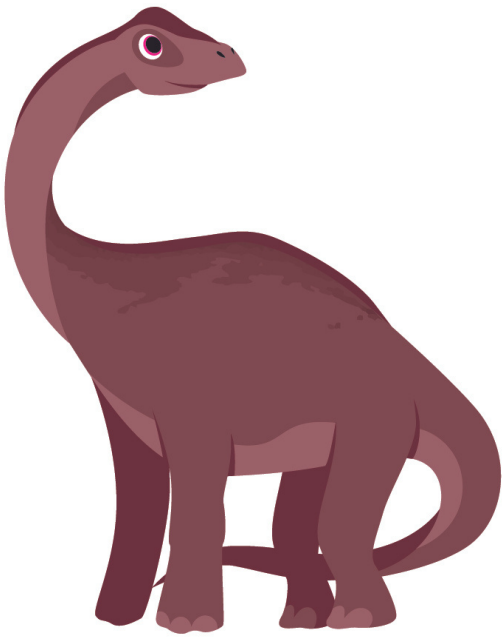

Colorie les bonnes lettres pour reconstituer le mot

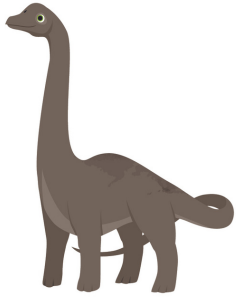

SPINOSAURE

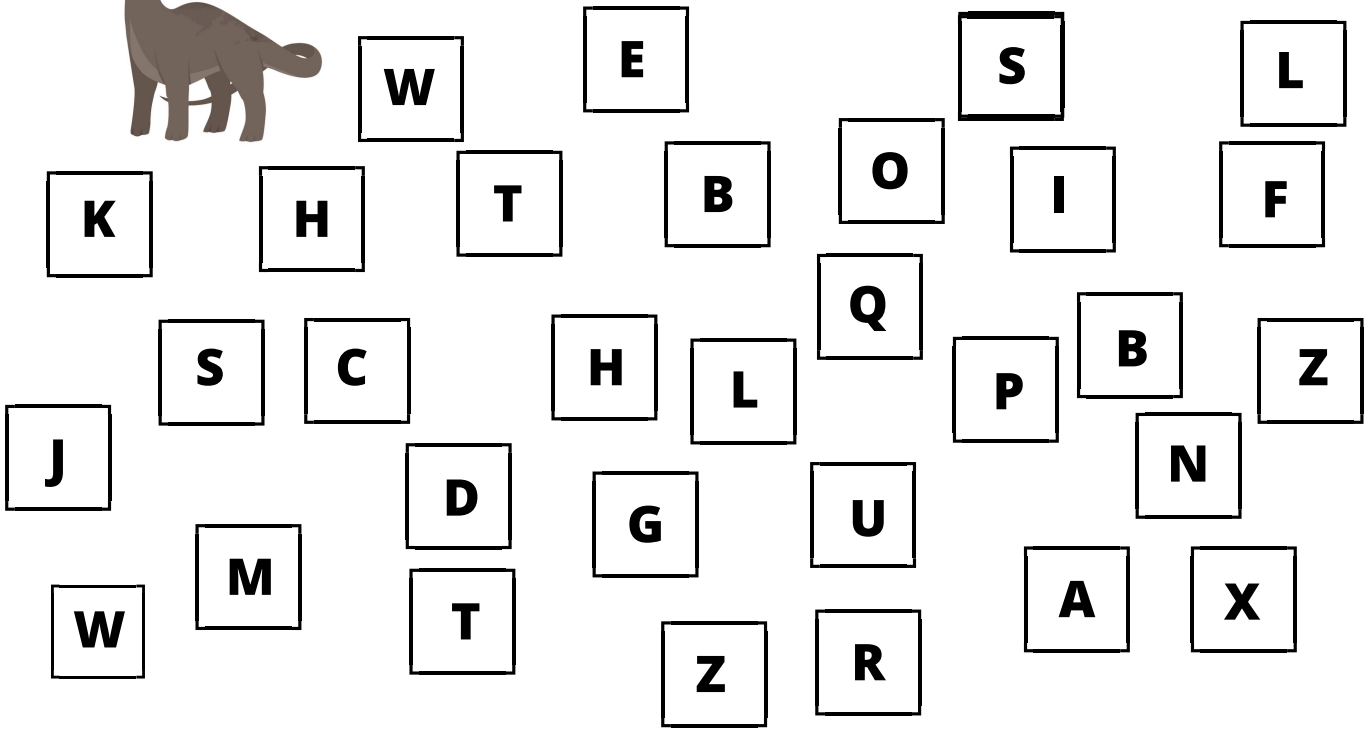

Combien de dinosaures, y a-t-il ?
Colorie la bonne réponse

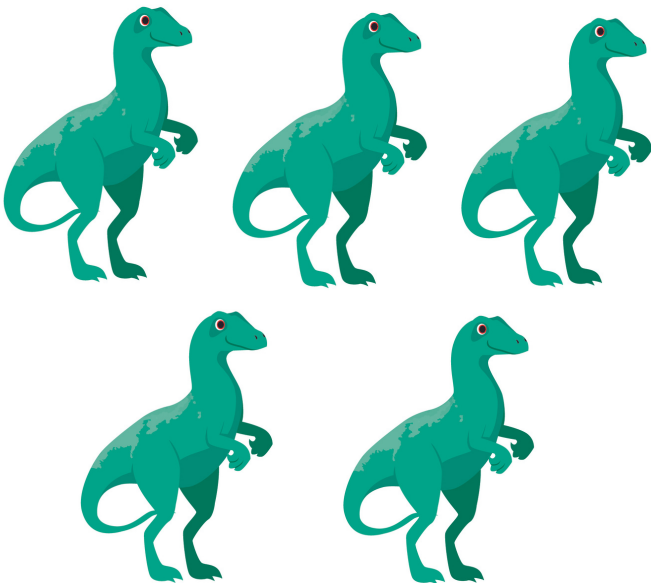

- 5
- 3
- 1



- 2
- 3
- 7
- 2

Relie tous les  pour retrouver ton chemin.

Tu peux tracer un chemin dans tous les sens, horizontalement, verticalement et en diagonale.

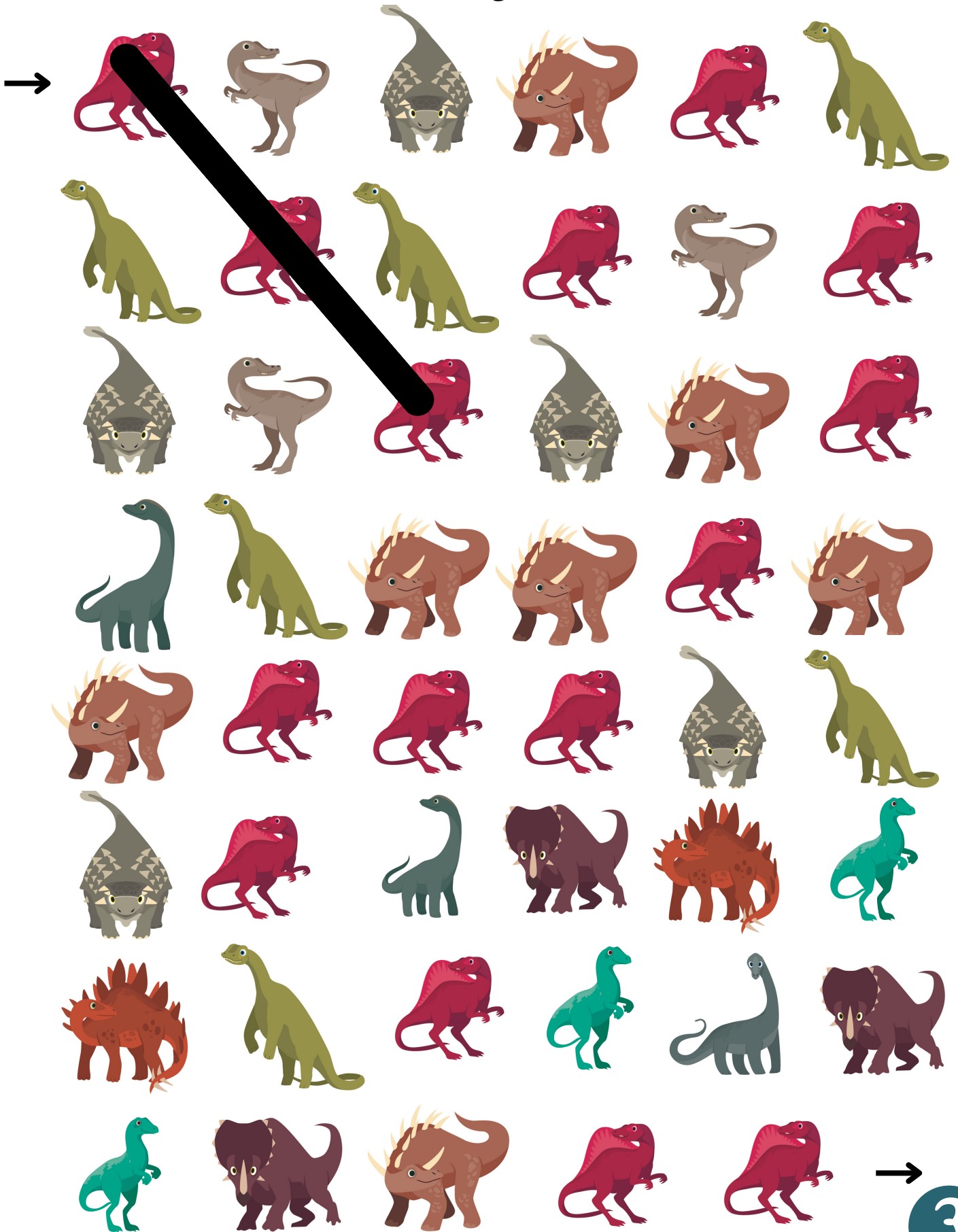

Trouve les 7 différences entre les deux photographies

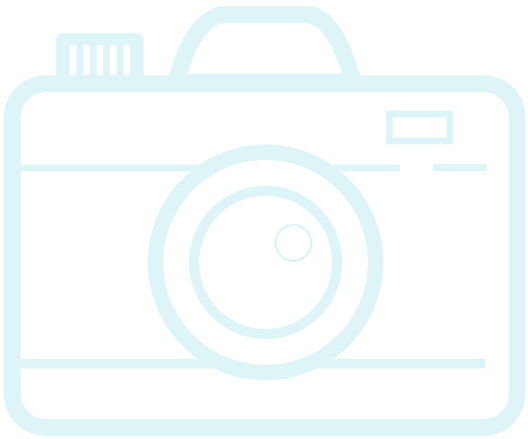

DATE 20 mars, 2023
SUJET Le velociraptor



DATE 20 mars, 2023
SUJET Le velociraptor

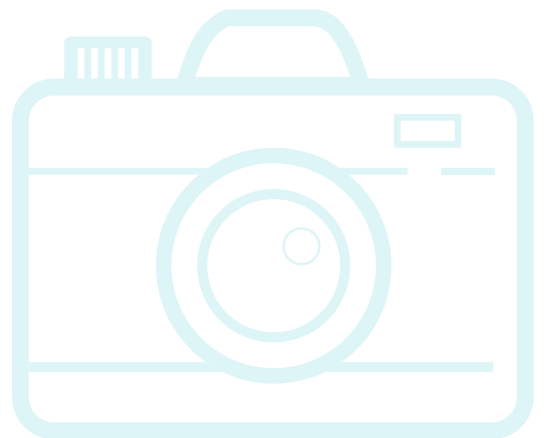

Aide les dinosaures à trouver leurs habitats naturels

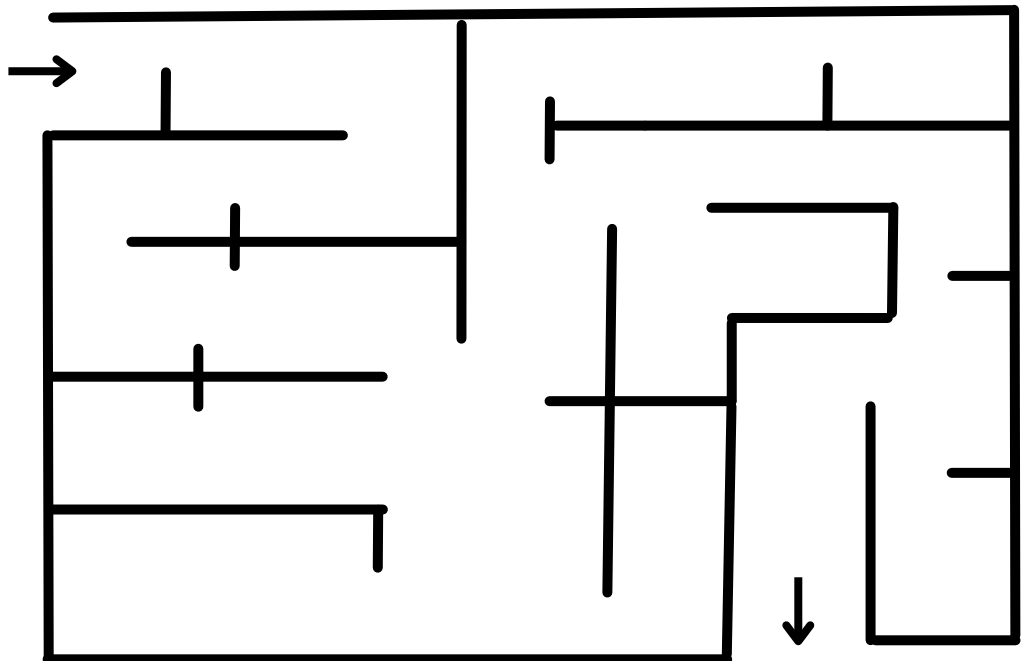
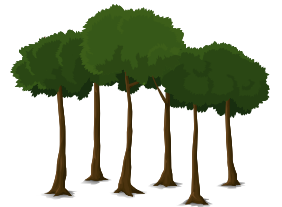
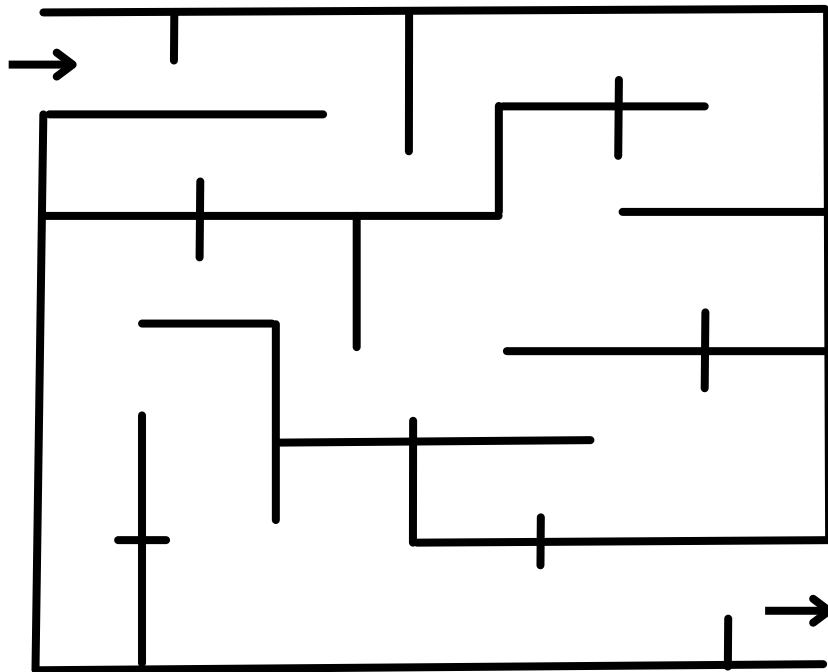

Découpe chaque lettre et complète
la grille



T	R	I	C	E	R	A	T	O	P	S



S	T	E	G	O	S	A	U	R	E



T

T	O	I	C	R	G	A	U	P	T
S	E	O	E	S	R	S	A	R	E

Colorie la silhouette du dinosaure

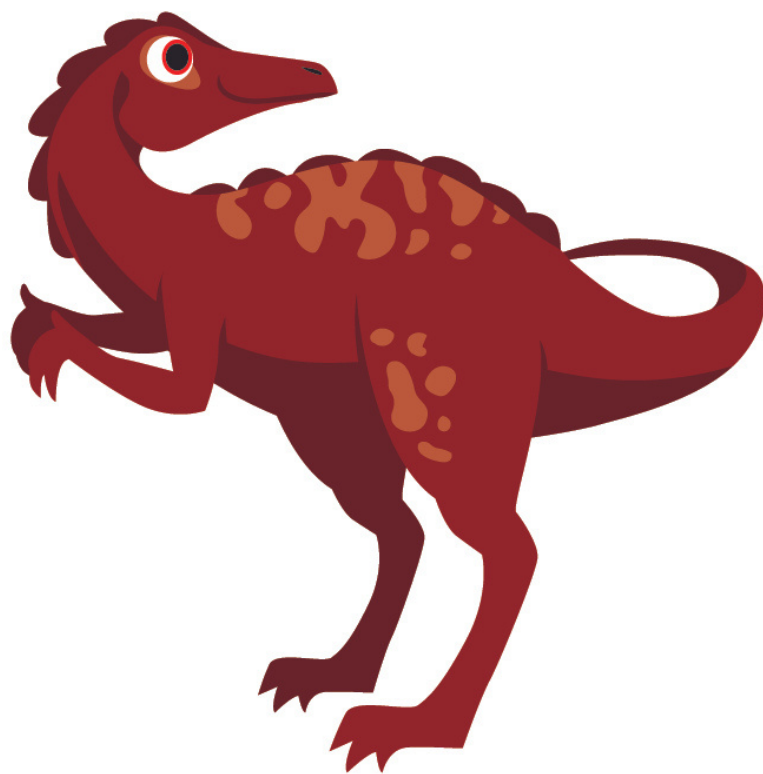
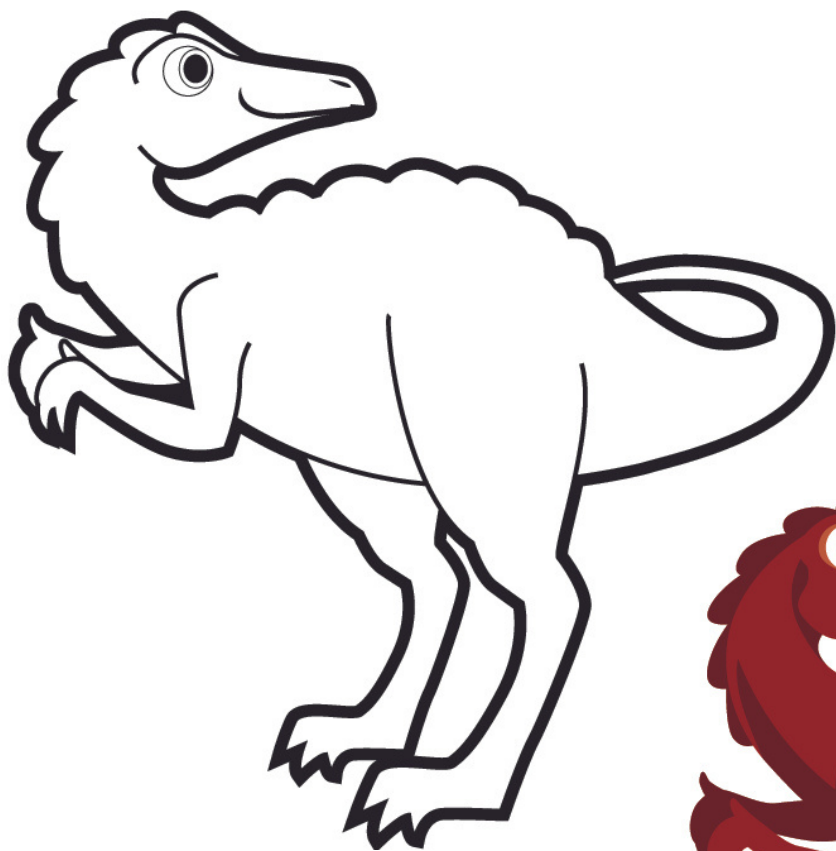

Des intrus se cachent parmi les dinosaurés, barre-les

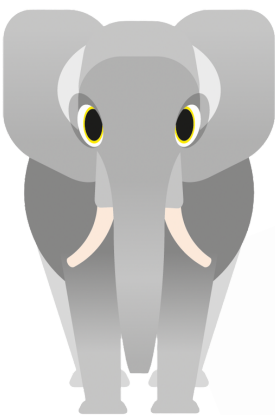

Colorie ta carte



Le cahier vous a plu ? Retrouvez tous les dinosaures dans nos jeux de cartes



Des jeux au concept unique qui allient loisirs créatifs et jeu de société.

Les enfants personnalisent leurs cartes avant d'y jouer en famille.

SOLUTIONS

